

BOM LIST			
ITEM	PART NAME	Q'ty	NOTES
1	PLASTIC HOOD	2	ABS
2	2.1 LONG BOLT	2	#4-40
	2.2 SHORT BOLT	2	#4-40
3	NUT	2	M3
4	LONG SCREW	2	M3
5	SMALL WASHER	2	
6	SHORT SCREW	2	M3
7	7.1 METAL WASHER	2	M3
	7.2 PLASTIC-1 WASHER	2	ABS
	7.3 PLASTIC-2 WASHER	2	ABS

REV.	DESCRIPTION	DRAWN	CHECKED	APPROVED
A	NEW RELEASE	LJH 08/13/05'	~	LJC 08/13/05'
B	整理图面	YCH 09/13/07'	~	

DSUB PLASTIC CASE (DP-9C)

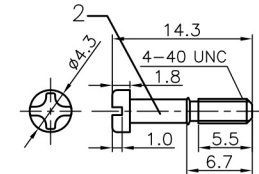
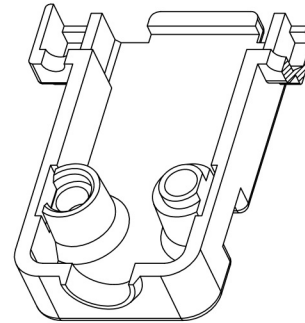
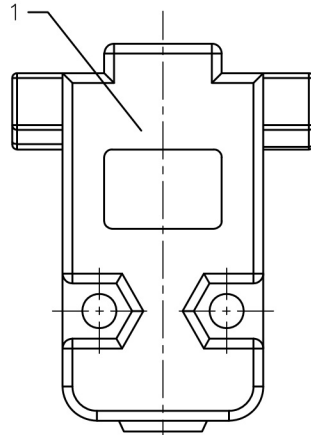
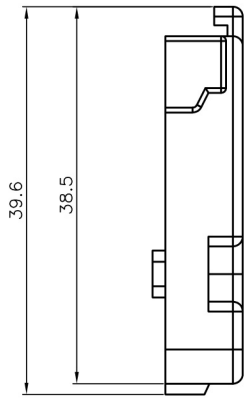
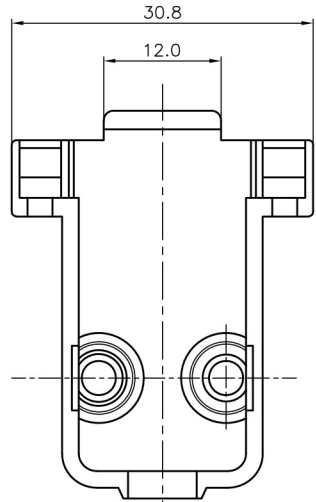
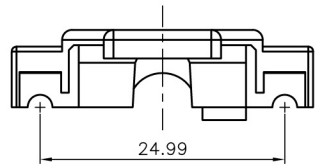

Short BOLT

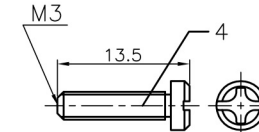

LONG SCREW

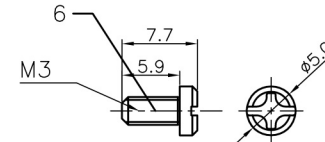

SHORT SCREW

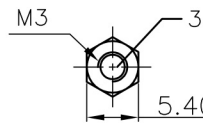

UNT t=2.3mm

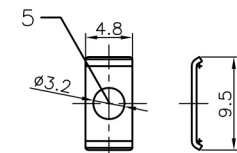

SMALL WASHER

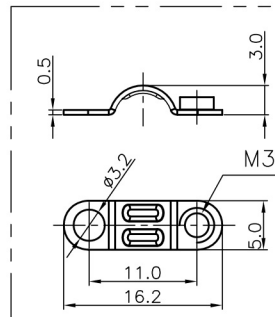
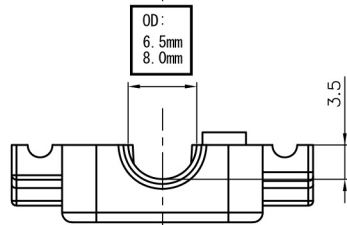

Metal

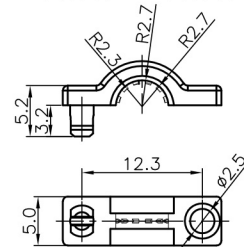

Plastic-1

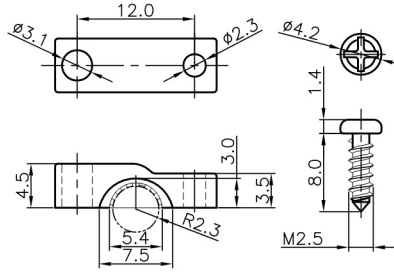

Plastic-2

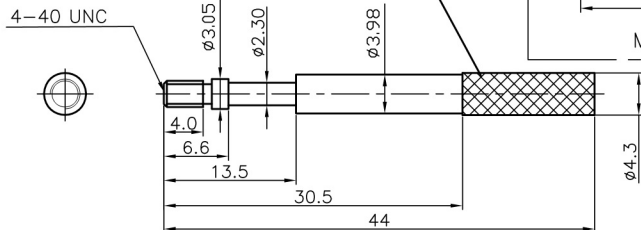

Long BOLT

GENERAL TOLERANCE		ANGLE TOLERANCE		PROJECTION	TITLE
X.	±0.60	X.	±5°	mm	
.X	±0.38	.X	±3°	UNITS	SHEET SIZE
.XX	±0.25	.XX	±2°	A4	SERIES
DRAWING TYPE		COSTOMER		DS1046 SERIES	
SCALE		1:1		<h1 style="text-align: center;">RUI CHI</h1>	
DRAWING NO.		C-DS1046-09XXXX			