

## SURFACE MOUNT HIGH EFFICIENCY RECTIFIER

### FEATURES

- Plastic package has underwrites laboratory flammability Classification 94V-0
- Glass passivated chip junction
- Built-in strain relief,
- Fast switching speed for high efficiency
- High temperature soldering guaranteed:250 /10 seconds

### MECHANICAL DATA

- Case: JEDED DO-214AB transfer molded plastic
- Terminals: Solder plated, solderable per MIL-STD-750, method 2026
- Polarity: Color band denotes cathode end
- Weight: 0.007 ounce, 0.25 gram

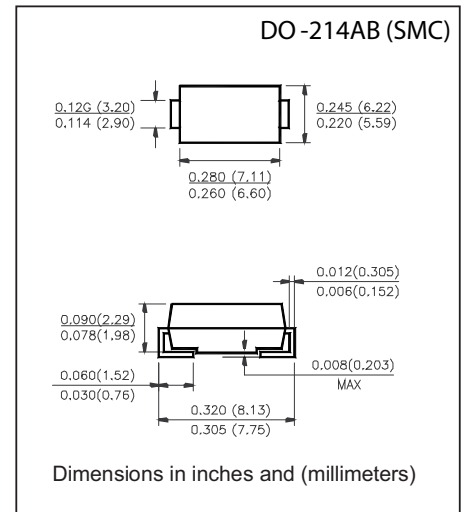

### MAXIMUM RATINGS AND ELECTRICAL CHARACTERISTICS

- Ratings at 25°C ambient temperature unless otherwise specified. Single phase, half wave, 60Hz, resistive or inductive load for capacitive load derate current by 20%..

PARAMETER	SYMBOLS	US3A	US3B	US3D	US3G	US3J	US3K	US3M	UNIT
Maximum Repetitive Peak Reverse Voltage	$V_{RRM}$	50	100	200	400	600	800	1000	Volts
Maximum RMS Voltage	$V_{RMS}$	35	70	140	280	420	560	700	Volts
Maximum DC Blocking Voltage	$V_{DC}$	50	100	200	400	600	800	1000	Volts
Maximum Average Forward Rectified Current At $T_L=105^\circ\text{C}$ (NOTE 1)	$I_{(AV)}$	3.0							Amps
Peak Forward Surge Current 8.3ms single half sine-wave superimposed on rated load (JEDEC Method)	$I_{FSM}$	100							Amps
Maximum Instantaneous Forward Voltage at 3.0A	$V_F$	1.0			1.3	1.7			Volts
Maximum DC Reverse Current at rated DC Blocking Voltage at	$T_A = 25^\circ\text{C}$	10							$\mu\text{A}$
	$T_A = 125^\circ\text{C}$	200							
Maximum Reverse Recovery Time Test conditions $I_F = 0.5\text{A}$ , $I_R = 1.0\text{A}$ , $I_{RR} = 0.25\text{A}$	$t_{rr}$	50				75			nS
Typical Junction Capacitance (Measured at 1.0MHz and applied reverse voltage of 4.0V)	$C_J$	50				30			pF
Typical Thermal Resistance (Note 1)	$R_{\theta JA}$	55							$^\circ\text{C}/\text{W}$
	$R_{\theta JL}$	17							
Operating Junction Temperature	$T_J$	(-55 to +150)							$^\circ\text{C}$
Storage Temperature Range	$T_{STG}$	(-55 to +150)							$^\circ\text{C}$

#### Notes:

1. Thermal resistance from Junction to ambient and from junction to lead mounted on P.C.B. with  $0.3 \times 0.3'' (8.0 \times 8.0\text{mm})$  copper pad areas.

## SURFACE MOUNT HIGH EFFICIENCY RECTIFIER

### RATING AND CHARACTERISTIC CURVES US3A - US3M

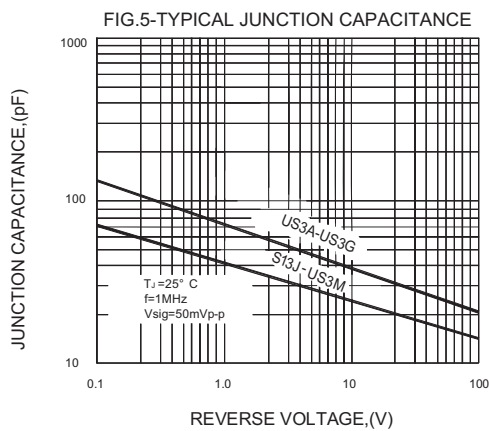
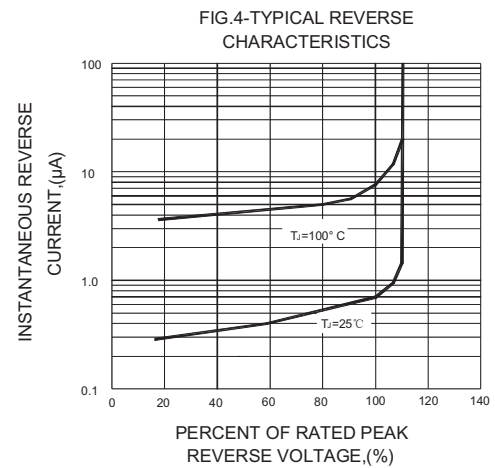
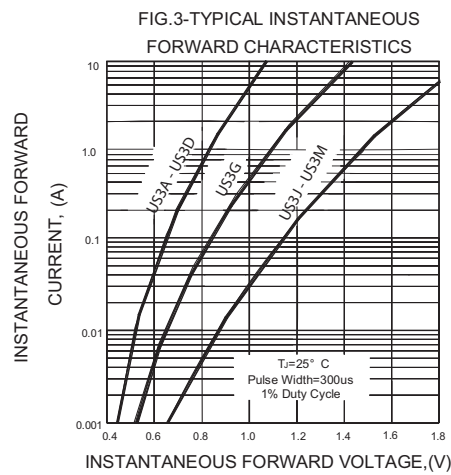
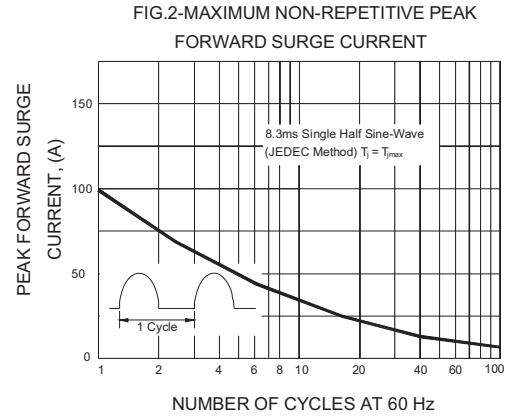
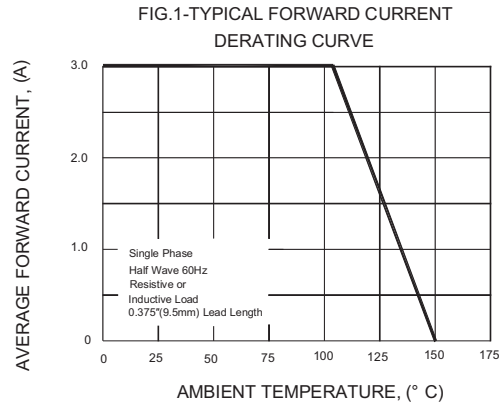

**FIG.6-TEST CIRCUIT DIAGRAM AND REVERSE RECOVERY TIME CHARACTERISTIC**

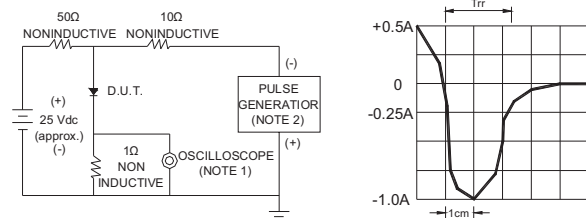

- NOTES : 1. Rise Time=7ns max. Input Impedance= 1 megohm. 22pF  
2. Rise time=10ns max. Source Impedance= 50 ohms

#### Disclaimer

All product, product specifications and data are subject to change without notice to improve reliability, function or design or otherwise.