

SuperESD - USBLC6-4SC6

1. Description

The USBLC6-4SC6 is designed to protect voltage sensitive components from ESD and transient voltage events. Excellent clamping capability, low leakage, and fast response time, make these parts ideal for ESD protection on designs where board space is at a premium.

2. Features

- IEC 61000-4-2 Level 4 ESD Protection
 - ±12kV Contact Discharge
 - ±17kV Air Discharge
- 60W Peak pulse Power (8/20us)
- Low clamping voltage
- Working voltage: 5V
- Low leakage current
- RoHS compliant
- Protecting 4 unidirectional lines
- Ultra-low capacitance: 0.6pF Typ.

3. Applications

- USB 2.0
- Monitors and flat panel displays
- 10/100/1000 ethernet
- Notebook computers
- SIM ports
- ATM interface

4. Ordering Information

| Part Number | Package | Marking | Material | Packing | Quantity per reel | Flammability Rating | Reel Size |
|-------------|-----------|---------|--------------|-------------|-------------------|---------------------|-----------|
| USBLC6-4SC6 | SOT-23-6L | .V05 | Halogen free | Tape & Reel | 3,000 PCS | UL 94V-0 | 7 inches |

Table-1 Ordering information

5. Pin Configuration and Functions

| Pin | Name | Description | Outline | Circuit Diagram |
|-----|------|----------------|---|---|
| 1 | IO1 | Connect to I/O |  |  |
| 2 | GND | Connect to GND | | |
| 3 | IO2 | Connect to I/O | | |
| 4 | IO3 | Connect to I/O | | |
| 5 | Vcc | Connect to Vcc | | |
| 6 | IO4 | Connect to I/O | | |

Table-2 Pin configuration

6. Specification

6.1. Absolute Maximum rating

Over operating free-air temperature range (unless otherwise noted)

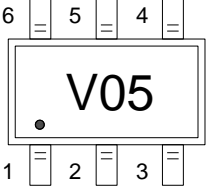
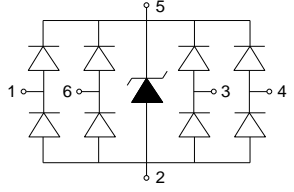
| Parameters | Symbol | Min. | Max. | Unit |
|--|------------------|------|------|------|
| Peak pulse power (tp=8/20us)@25°C | P _{pk} | - | 60 | W |
| Peak pulse current (tp=8/20us)@25°C | I _{PP} | | 4.5 | A |
| ESD (IEC61000-4-2 air discharge) @25°C | V _{ESD} | - | ±17 | kV |
| ESD (IEC61000-4-2 contact discharge) @25°C | V _{ESD} | - | ±12 | kV |
| Junction temperature | T _J | - | 150 | °C |
| Operating temperature | T _{OP} | -40 | 125 | °C |
| Storage temperature | T _{STG} | -55 | 150 | °C |

| | | | | |
|------------------|-------|---|-----|-------------|
| Lead temperature | T_L | - | 260 | $^{\circ}C$ |
|------------------|-------|---|-----|-------------|

Table-3 Absolute Maximum rating

6.2. Electrical Characteristics

At $T_A = 25^{\circ}C$ unless otherwise noted

| Parameter | Symbol | Conditions | Min. | Typ. | Max. | Units |
|---------------------------|-----------|----------------------------------|------|------|------|---------|
| Reverse Stand-off Voltage | V_{RWM} | | | | 5 | V |
| Reverse Breakdown Voltage | V_{BR} | $I_T=1mA$ | 6 | | | V |
| Reverse Leakage Current | I_R | $V_{RWM}=5V$ | | | 1 | μA |
| Clamping Voltage | V_C | $I_{PP}=1A$; $t_p=8/20\mu s$ | | 9 | | V |
| Clamping Voltage | V_C | $I_{PP}=4.5A$; $t_p=8/20\mu s$ | | 12 | | V |
| Junction Capacitance | C_J | I/O to GND; $V_R=0V$; $f=1MHz$ | | 0.6 | 0.8 | pF |
| | | Between I/O; $V_R=0V$; $f=1MHz$ | | 0.3 | 0.4 | pF |

Table-4 Electrical Characteristics

| Symbol | Parameters |
|-----------|-------------------------------------|
| V_{RWM} | Peak Reverse Working Voltage |
| I_R | Reverse Leakage Current @ V_{RWM} |
| V_{BR} | Breakdown Voltage @ I_T |
| I_T | Test Current |
| I_{PP} | Maximum Reverse Peak Pulse Current |
| V_C | Clamping Voltage @ I_{PP} |
| I_F | Forward Current |
| V_F | Forward Voltage @ I_F |

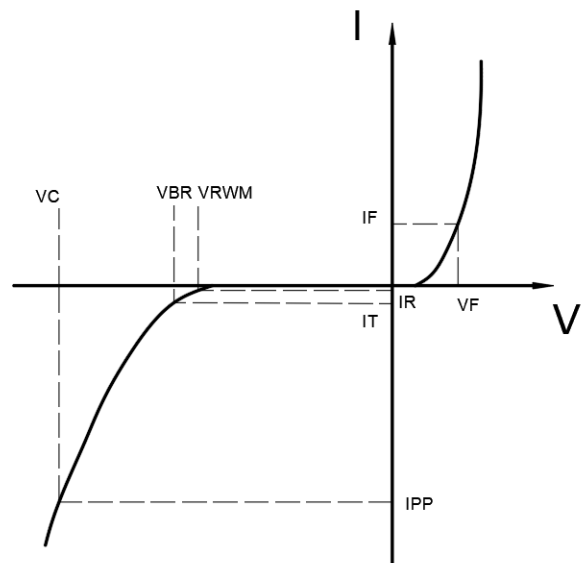

7. Typical Characteristic

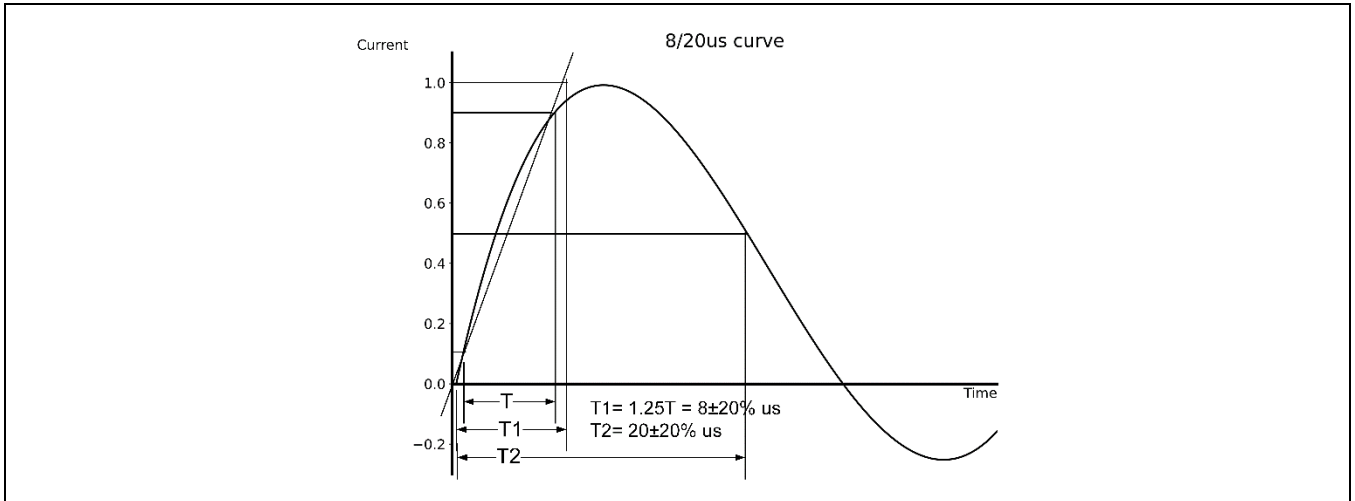

8. Typical Application

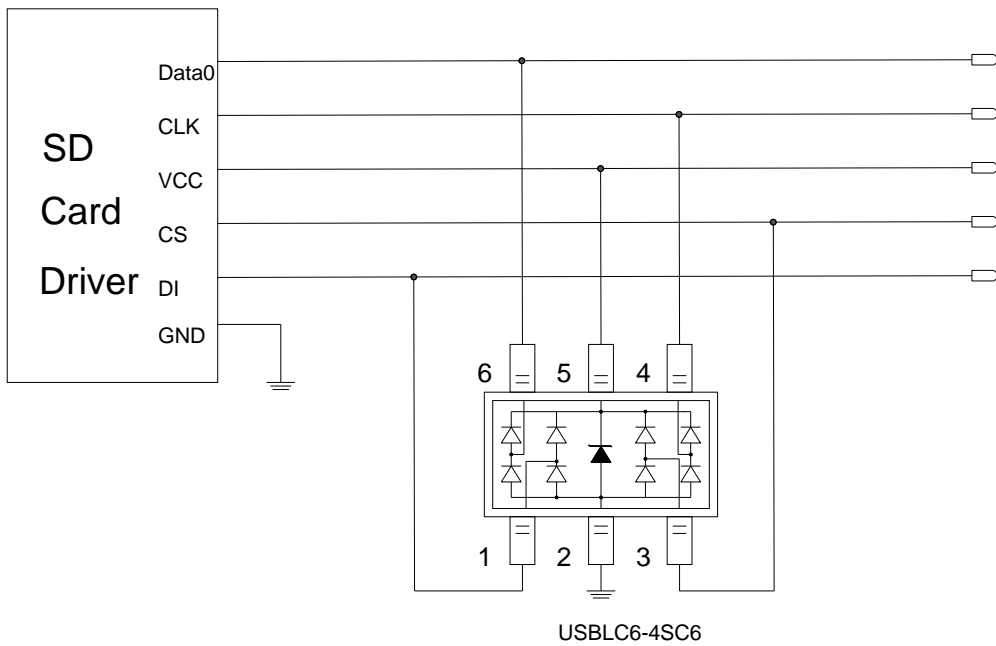

Typical Interface Application

9. Dimension(SOT-23-6L)

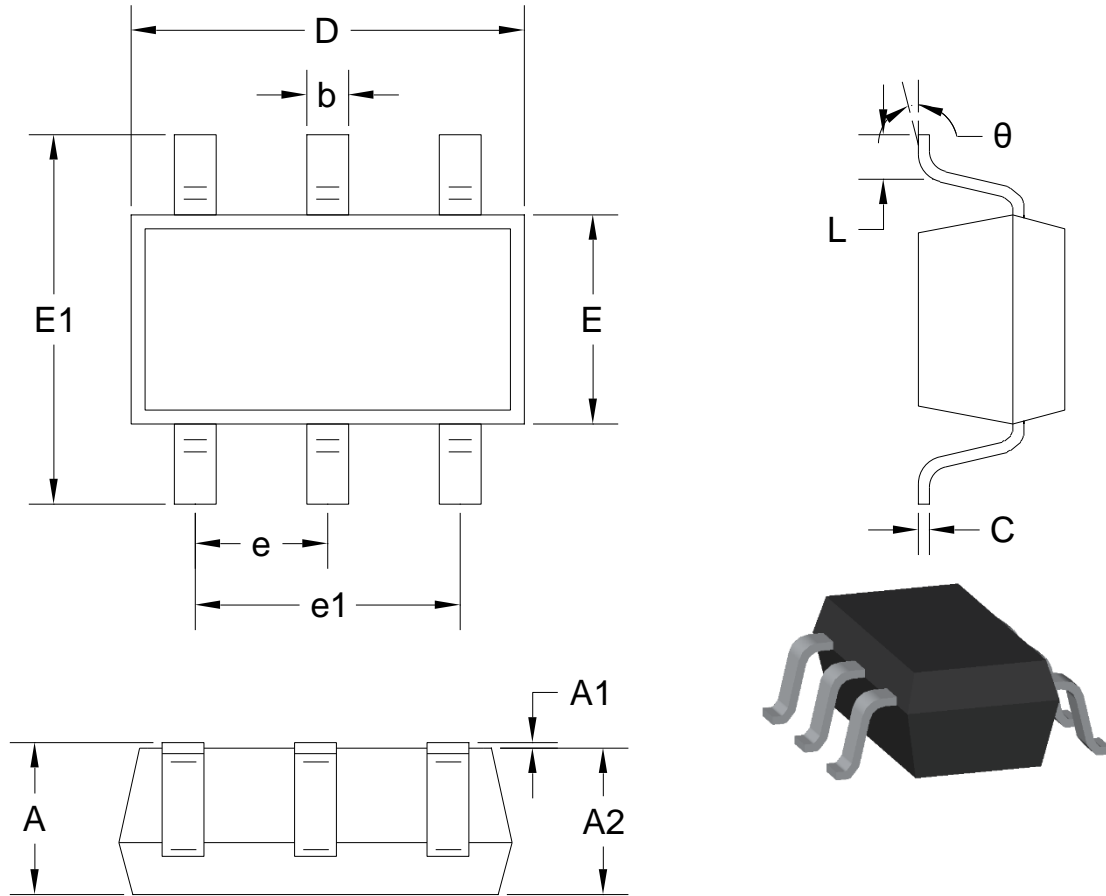

Unit: mm

| Symbol | | A | A1 | A2 | b | c | D |
|--------|-----|-------|-------|----------|-------|-------|----------|
| Spec | Min | 1.050 | 0.000 | 1.050 | 0.300 | 0.100 | 2.820 |
| | Max | 1.250 | 0.100 | 1.150 | 0.500 | 0.200 | 3.020 |
| Symbol | | E | E1 | e | e1 | L | θ |
| Spec | Min | 1.500 | 2.650 | 0.950BSC | 1.800 | 0.300 | 0° |
| | Max | 1.700 | 2.950 | | 2.000 | 0.600 | 8° |

Table-5 Product dimensions in millimeter

10. Recommended Land Pattern

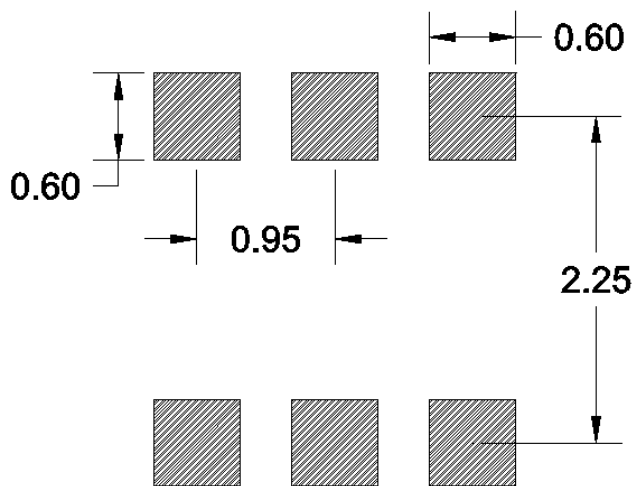

Note:

1. Controlling dimension: in millimeters
2. General tolerance: $\pm 0.05\text{mm}$
3. The pad layout is for reference only

DISCLAIMER

ELECSUPER PROVIDES TECHNICAL AND RELIABILITY DATA (INCLUDING DATASHEETS), DESIGN RESOURCES (INCLUDING REFERENCE DESIGNS), APPLICATION OR OTHER DESIGN ADVICE, SAFETY INFORMATION, AND OTHER RESOURCES “AS IS” AND WITH ALL FAULTS, AND DISCLAIMS ALL WARRANTIES, EXPRESS AND IMPLIED, INCLUDING WITHOUT LIMITATION ANY IMPLIED WARRANTIES OF MERCHANTABILITY, FITNESS FOR A PARTICULAR PURPOSE OR NON-INFRINGEMENT OF THIRD PARTY INTELLECTUAL PROPERTY RIGHTS.

These resources are intended for skilled developers designing with ElecSuper products. You are solely responsible for

- (1) selecting the appropriate ElecSuper products for your application;
- (2) designing, validating and testing your application;
- (3) ensuring your application meets applicable standards, and any other safety, security, or other requirements.

These resources are subject to change without notice. ElecSuper grants you permission to use these resources only for development of an application that uses the ElecSuper products described in the resource. Other reproduction and display of these resources are prohibited. No license is granted to any other ElecSuper intellectual property right or to any third party intellectual property right. ElecSuper disclaims responsibility for, and you will fully indemnify ElecSuper and its representatives against, any claims, damages, costs, losses, and liabilities arising out of your use of these resources. ElecSuper's products are provided subject to ElecSuper's Terms of Sale or other applicable terms available either on www.elecsuper.com or provided in conjunction with such ElecSuper products. ElecSuper's provision of these resources does not expand or otherwise alter ElecSuper's applicable warranties or warranty disclaimers for ElecSuper products.