

Three-terminal positive voltage regulator  
 OUTPUT CURRENT TO 1.2A  
 OUTPUT VOLTAGES OF 5; 6; 8; 9; 12V  
 THERMAL OVERLOAD PROTECTION  
 SHORT CIRCUIT PROTECTION  
 OUTPUT TRANSITION SOA PROTECTION

## 1、 Absolute Maximum Ratings $T_c=25^{\circ}\text{C}$

Symbol	Parameter	Value	UNIT
$V_I$	Input Voltage	35	V
TOPR	Operating Temperature Range	0 ~ +125	$^{\circ}\text{C}$
TSTG	Storage Temperature Range	-65 ~ +150	$^{\circ}\text{C}$

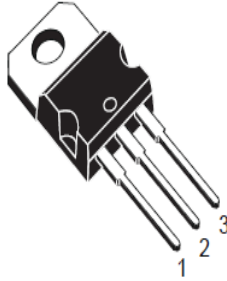

**TO-220**

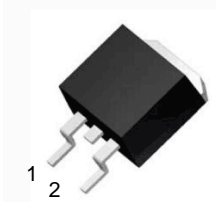

**TO-263-3**

1 Input 2 Gnd 3 Out

## 2、 Electrical Characteristics ( $T_c=25^{\circ}\text{C}$ ) Of 7805 (refer to the test circuits, $T_J = -55$ to $150^{\circ}\text{C}$ $V_I = 10\text{V}$ , $I_O = 500\text{mA}$ , $C_I = 0.33\ \mu\text{F}$ , $C_O = 0.1\ \mu\text{F}$ unless otherwise specified)。

Parameter	Symbol	Test Condition	MIN	TYP	MAX	UNIT
Output Voltage	$V_O$	$T_J = +25^{\circ}\text{C}$	4.8	5	5.2	V
		$I_O = 5\text{mA to } 1\text{A}$ , $P_O \leq 15\text{W}$ $V_I = 8\text{V to } 20\text{V}$	4.75	5	5.25	
Line Regulation (Notel)	$\Delta V_O$	$T_J = +25^{\circ}\text{C}$	$V_I = 7\text{V to } 25\text{V}$		100	mV
			$V_I = 8\text{V to } 12\text{V}$		50	
Load Regulation (Notel)	$\Delta V_O$	$T_J = +25^{\circ}\text{C}$ $I_O = 5\text{mA to } 1.2\text{A}$			100	mV
		$T_J = +25^{\circ}\text{C}$ $I_O = 250\text{mA to } 750\text{mA}$			50	
Quiescent Current	$I_Q$	$T_J = +25^{\circ}\text{C}$			6	mA
Quiescent Current Change	$\Delta I_Q$	$I_O = 5\text{mA to } 1\text{A}$			0.5	mA
		$V_I = 8\text{V to } 25\text{V}$			0.8	
Quiescent Current Change	$\Delta V_O/\Delta T$	$I_O = 5\text{mA}$		0.6		mV/ $^{\circ}\text{C}$
Short Circuit Current	ISC	$T_J = +25^{\circ}\text{C}$ , $V_I = 35\text{V}$		0.75	1.2	A

- 3、Electrical Characteristics ( $T_c=25^{\circ}\text{C}$ ) Of 7806(refer to the test circuits, $T_J = -55$  to  $150^{\circ}\text{C}$   $V_I = 11\text{V}$  ,  
 $I_O = 500\text{ mA}$  ,  $C_I = 0.33\ \mu\text{F}$  ,  $C_O = 0.1\ \mu\text{F}$  unless otherwise specified).

Parameter	Symbol	Test Condition	MIN	TYP	MAX	UNIT	
Output Voltage	$V_O$	$T_J = +25^{\circ}\text{C}$	5.75	6	6.25	V	
		$I_O = 5\text{mA to } 1\text{A}$ , $P_O \leq 15\text{W}$ $V_I = 9\text{V to } 21\text{V}$	5.7	6	6.3		
Line Regulation (Note1)	$\Delta V_O$	$T_J = +25^{\circ}\text{C}$	$V_I = 8\text{V to } 25\text{V}$			100	mV
			$V_I = 9\text{V to } 13\text{V}$			50	
Load Regulation (Note1)	$\Delta V_O$	$T_J = +25^{\circ}\text{C}$ $I_O = 5\text{mA to } 1.2\text{A}$			100	mV	
		$T_J = +25^{\circ}\text{C}$ $I_O = 250\text{mA to } 750\text{mA}$			50		
Quiescent Current	$I_Q$	$T_J = +25^{\circ}\text{C}$			6	mA	
Quiescent Current Change	$\Delta I_Q$	$I_O = 5\text{mA to } 1\text{A}$			0.5	mA	
		$V_I = 9\text{V to } 25\text{V}$			0.8		
Quiescent Current Change	$\Delta V_O/\Delta T$	$I_O = 5\text{mA}$		0.7		mV/ $^{\circ}\text{C}$	
Short Circuit Current	$I_{SC}$	$T_J = +25^{\circ}\text{C}$ , $V_I = 35\text{V}$		0.75	1.2	A	

4、Electrical Characteristics ( $T_c=25^{\circ}\text{C}$ ) Of 7808(refer to the test circuits,  $T_J = -55$  to  $150^{\circ}\text{C}$   $V_I = 14\text{V}$ ,  $I_O = 500\text{ mA}$ ,  $C_I = 0.33\ \mu\text{F}$ ,  $C_O = 0.1\ \mu\text{F}$  unless otherwise specified)。

Parameter	Symbol	Test Condition	MIN	TYP	MAX	UNIT	
Output Voltage	$V_O$	$T_J = +25^{\circ}\text{C}$	7.7	8	8.3	V	
		$I_O = 5\text{mA to } 1\text{A}$ , $P_O \leq 15\text{W}$ $V_I = 11.5\text{V to } 23\text{V}$	7.6	8	8.4		
Line Regulation (Notel)	$\Delta V_O$	$T_J = +25^{\circ}\text{C}$	$V_I = 10.5\text{V to } 25\text{V}$			100	mV
			$V_I = 11\text{V to } 17\text{V}$			50	
Load Regulation (Notel)	$\Delta V_O$	$T_J = +25^{\circ}\text{C}$ $I_O = 5\text{mA to } 1.2\text{A}$			100	mV	
		$T_J = +25^{\circ}\text{C}$ $I_O = 250\text{mA to } 750\text{mA}$			50		
Quiescent Current	$I_Q$	$T_J = +25^{\circ}\text{C}$			6	mA	
Quiescent Current Change	$\Delta I_Q$	$I_O = 5\text{mA to } 1\text{A}$			0.5	mA	
		$V_I = 11.5\text{V to } 25\text{V}$			1		
Quiescent Current Change	$\Delta V_O/\Delta T$	$I_O = 5\text{mA}$		1		mV/ $^{\circ}\text{C}$	
Short Circuit Current	ISC	$T_J = +25^{\circ}\text{C}$ , $V_I = 35\text{V}$		0.75	1.2	A	

5、Electrical Characteristics ( $T_c=25^{\circ}\text{C}$ ) Of 7809(refer to the test circuits,  $T_J = -55$  to  $150^{\circ}\text{C}$   $V_I = 15\text{V}$ ,  $I_O = 500\text{ mA}$ ,  $C_I = 0.33\ \mu\text{F}$ ,  $C_O = 0.1\ \mu\text{F}$  unless otherwise specified)。

Parameter	Symbol	Test Condition	MIN	TYP	MAX	UNIT	
Output Voltage	$V_O$	$T_J = +25^{\circ}\text{C}$	8.64	9	9.36	V	
		$I_O = 5\text{mA to }1\text{A}$ , $P_O \leq 15\text{W}$ $V_I = 11.5\text{V to }26\text{V}$	8.55	9	9.45		
Line Regulation (Note1)	$\Delta V_O$	$T_J = +25^{\circ}\text{C}$	$V_I = 11.5\text{V to }26\text{V}$			100	mV
			$V_I = 12\text{V to }18\text{V}$			50	
Load Regulation (Note1)	$\Delta V_O$	$T_J = +25^{\circ}\text{C}$	$I_O = 5\text{mA to }1.2\text{A}$			100	mV
			$I_O = 250\text{mA to }750\text{mA}$			50	
Quiescent Current	$I_Q$	$T_J = +25^{\circ}\text{C}$			6	mA	
Quiescent Current Change	$\Delta I_Q$	$T_J = +25^{\circ}\text{C}$	$I_O = 5\text{mA to }1\text{A}$			0.5	mA
			$V_I = 11.5\text{V to }26\text{V}$			1	
Quiescent Current Change	$\Delta V_O/\Delta T$	$I_O = 5\text{mA}$		1		mV/ $^{\circ}\text{C}$	
Short Circuit Current	ISC	$T_J = +25^{\circ}\text{C}$ , $V_I = 35\text{V}$		0.75	1.2	A	

6、Electrical Characteristics ( $T_c=25^{\circ}\text{C}$ ) Of 7812 (refer to the test circuits,  $T_J = -55$  to  $150^{\circ}\text{C}$   $V_I = 19\text{V}$ ,  $I_O = 500\text{ mA}$ ,  $C_I = 0.33\ \mu\text{F}$ ,  $C_O = 0.1\ \mu\text{F}$  unless otherwise specified)。

Parameter	Symbol	Test Condition	MIN	TYP	MAX	UNIT
Output Voltage	$V_O$	$T_J = +25^{\circ}\text{C}$	11.5	12	12.5	V
		$I_O = 5\text{mA to } 1\text{A}$ , $P_O \leq 15\text{W}$ $V_I = 15.5\text{V to } 27\text{V}$	11.4	12	12.6	
Line Regulation (Note1)	$\Delta V_O$	$T_J = +25^{\circ}\text{C}$	$V_I = 14.5\text{V to } 30\text{V}$		100	mV
			$V_I = 16\text{V to } 22\text{V}$		50	
Load Regulation (Note1)	$\Delta V_O$	$T_J = +25^{\circ}\text{C}$ $I_O = 5\text{mA to } 1.2\text{A}$			100	mV
		$T_J = +25^{\circ}\text{C}$ $I_O = 250\text{mA to } 750\text{mA}$			50	
Quiescent Current	$I_Q$	$T_J = +25^{\circ}\text{C}$			6	mA
Quiescent Current Change	$\Delta I_Q$	$I_O = 5\text{mA to } 1\text{A}$			0.5	mA
		$V_I = 15\text{V to } 30\text{V}$			1	
Quiescent Current Change	$\Delta V_O/\Delta T$	$I_O = 5\text{mA}$		1.5		mV/ $^{\circ}\text{C}$
Short Circuit Current	ISC	$T_J = +25^{\circ}\text{C}$ , $V_I = 35\text{V}$		0.75	1.2	A

## 7、Typical Characteristics

Figure 1: Dropout Voltage vs Junction Temperature

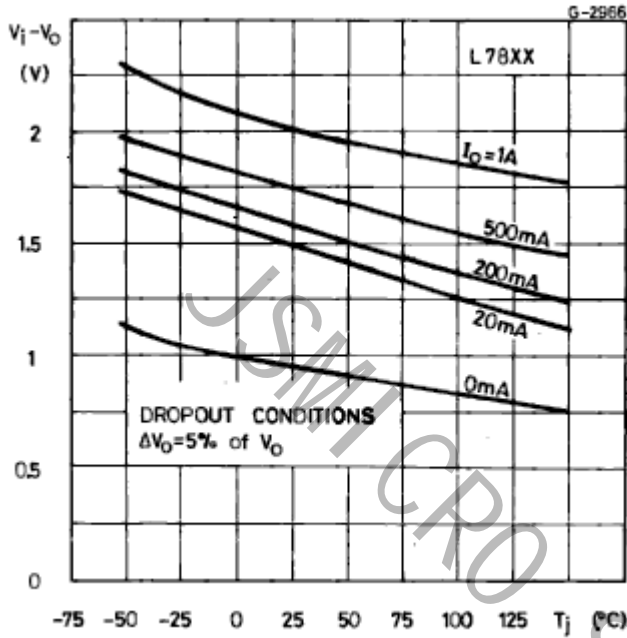

Figure 2: Peak Output Current vs Input/output Differential Voltage

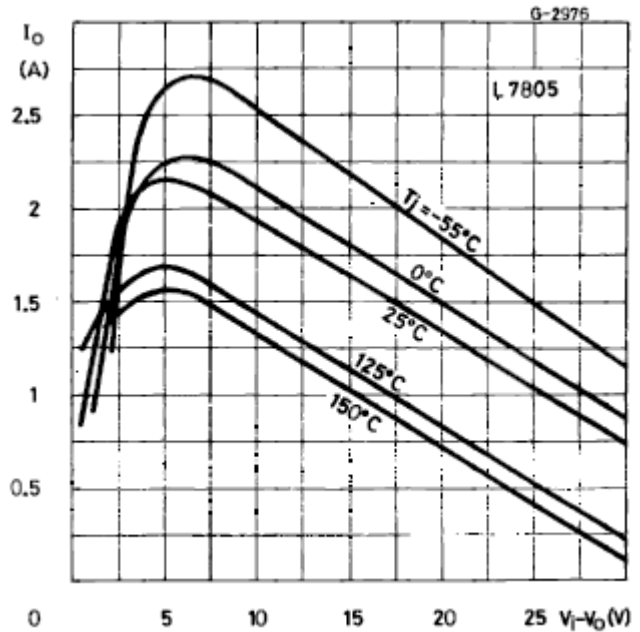

Figure 3: Supply Voltage Rejection vs Frequency

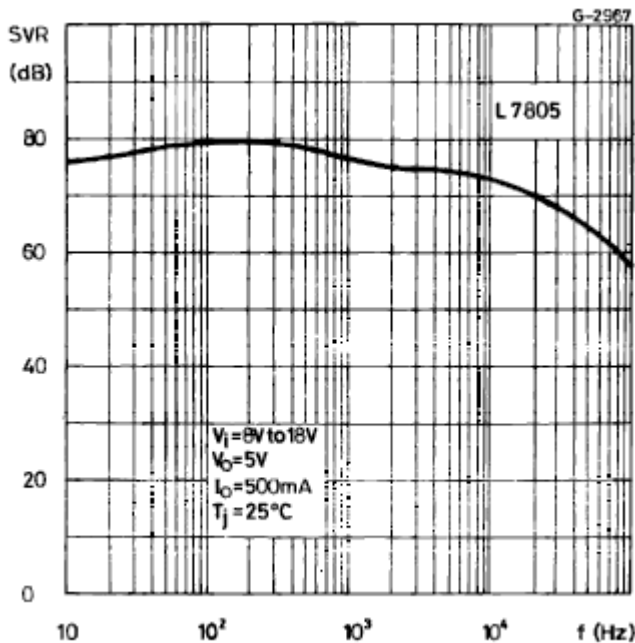

Figure 4: Quiescent Current vs Junction Temperature

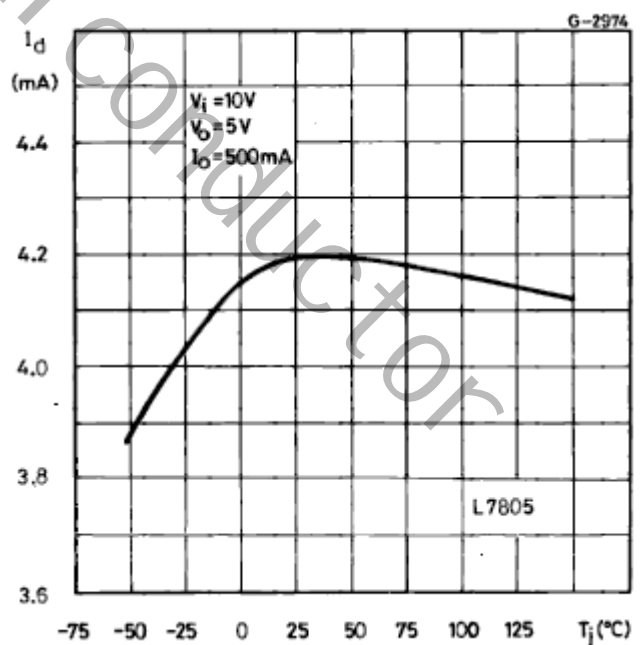

Figure 5: Output Voltage vs Junction Temperature

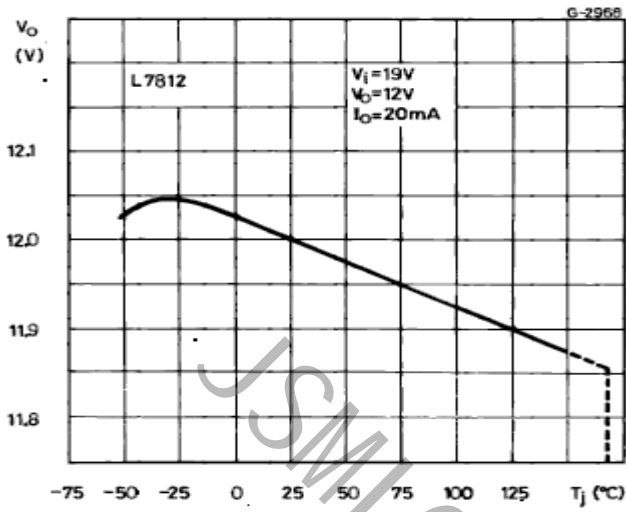

Figure 6: Load Transient Response

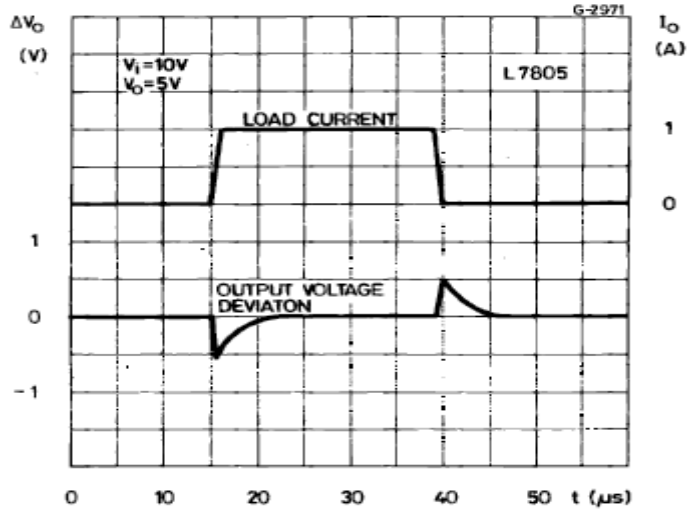

Figure 7: Output Impedance vs Frequency

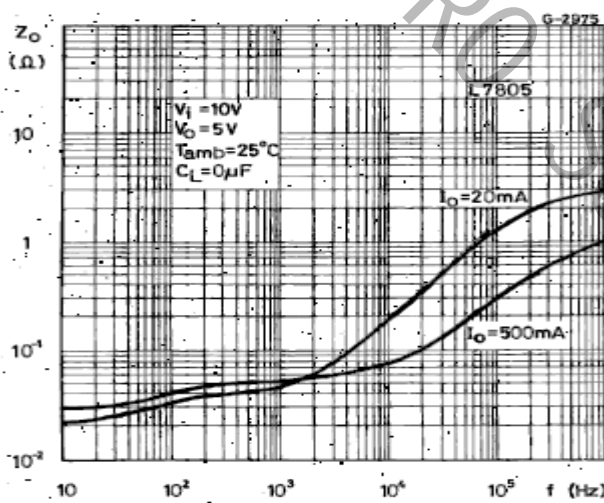

Figure 8: Line Transient Response

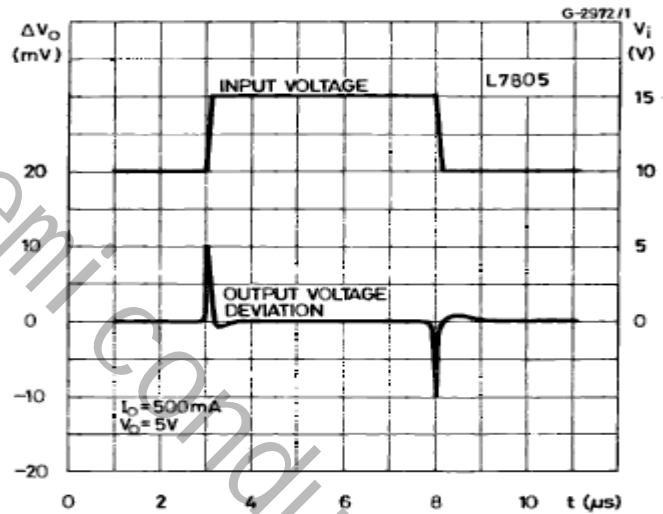
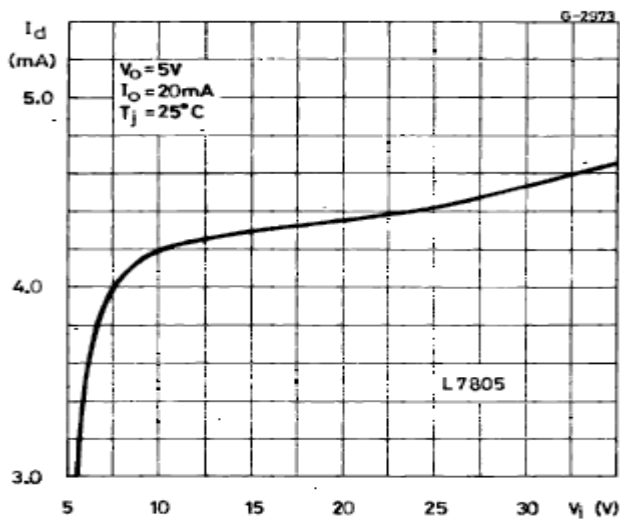

Figure 9: Quiescent Current vs Input Voltage



8、Package Demensions

T0-263-3

T0-263封装尺寸:

UNIT: mm

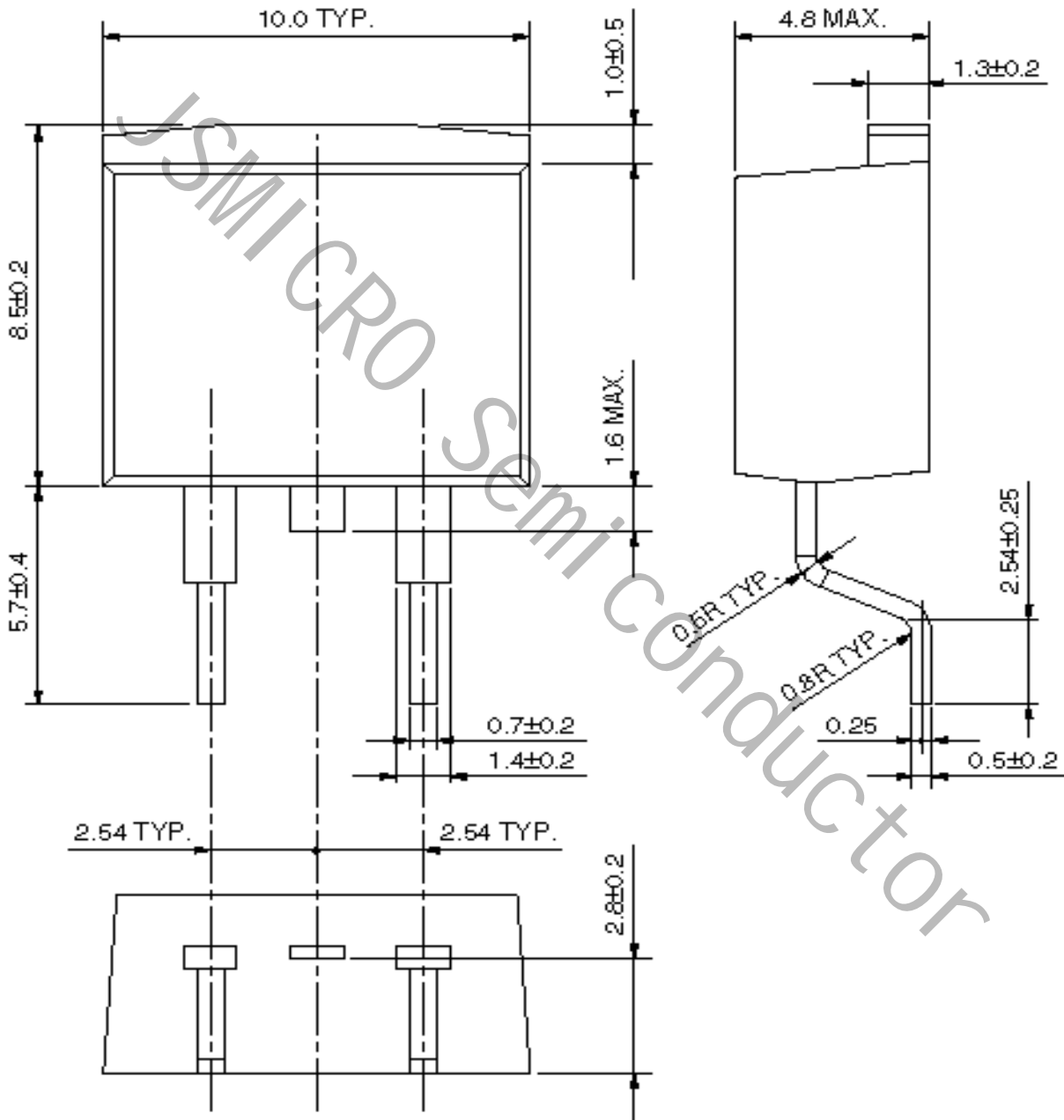

: The area without solder plated



## 9、Package Demensions

T0-220

DIM.	mm.			inch		
	MIN.	TYP.	MAX.	MIN.	TYP.	MAX.
A	4.40		4.60	0.173		0.181
b	0.61		0.88	0.024		0.034
b1	1.15		1.70	0.045		0.067
c	0.49		0.70	0.019		0.027
D	15.25		15.75	0.600		0.620
E	10.0		10.40	0.393		0.409
e	2.4		2.7	0.094		0.106
e1	4.95		5.15	0.194		0.203
F	1.23		1.32	0.048		0.051
H1	6.2		6.6	0.244		0.260
J1	2.40		2.72	0.094		0.107
L	13.0		14.0	0.511		0.551
L1	3.5		3.93	0.137		0.154
L20		16.4			0.645	
L30		28.9			1.138	
φP	3.75		3.85	0.147		0.151
Q	2.65		2.95	0.104		0.116

