

Features

- Ideally Suited for Automatic Assembly
- Low Forward Voltage Drop, High Efficiency
- Surge Overload Rating to 50A Peak
- Low Power Loss
- Ultra-Fast Recovery Time
- Plastic Case Material has UL Flammability Classification Rating 94V-O

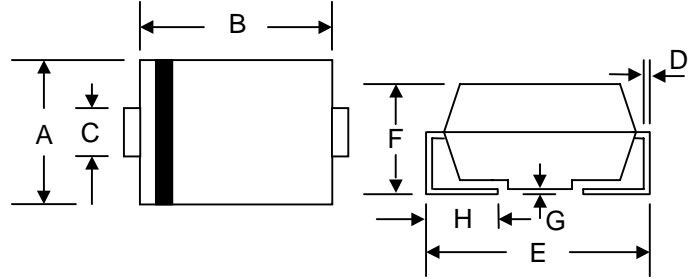

Mechanical Data

- Case: SMB/DO-214AA, Molded Plastic
- Terminals: Solder Plated, Solderable per MIL-STD-750, Method 2026
- Polarity: Cathode Band or Cathode Notch
- Marking: Type Number
- Weight: 0.093 grams (approx.)
- **Lead Free: For RoHS / Lead Free Version**

SMB/DO-214AA		
Dim	Min	Max
A	3.30	3.94
B	4.06	4.57
C	1.96	2.21
D	0.15	0.31
E	5.00	5.59
F	2.00	2.62
G	0.10	0.20
H	0.76	1.52
All Dimensions in mm		

Maximum Ratings and Electrical Characteristics @ $T_A=25^\circ\text{C}$ unless otherwise specified

Characteristic	Symbol	MURS 210	MURS 220	MURS 230	MURS 240	MURS 260	MURS 280	MURS 2100	Unit
Peak Repetitive Reverse Voltage	V_{RRM}	50	100	200	400	600	800	1000	V
Working Peak Reverse Voltage	V_{RWM}								
DC Blocking Voltage	V_R								
RMS Reverse Voltage	$V_{R(RMS)}$	35	70	140	280	420	560	800	V
Average Rectified Output Current @ $T_L = 100^\circ\text{C}$	I_O	2.0							A
Non-Repetitive Peak Forward Surge Current 8.3ms Single half sine-wave superimposed on rated load (JEDEC Method)	I_{FSM}	50							A
Forward Voltage @ $I_F = 2.0\text{A}$	V_{FM}	1.0		1.3		1.7			V
Peak Reverse Current @ $T_A = 25^\circ\text{C}$ At Rated DC Blocking Voltage @ $T_A = 100^\circ\text{C}$	I_{RM}	2.0 500							μA
Reverse Recovery Time (Note 1)	t_{rr}	50				75			nS
Typical Junction Capacitance (Note 2)	C_j	25							pF
Typical Thermal Resistance (Note 3)	$R_{\theta JL}$	30							$^\circ\text{C/W}$
Operating and Storage Temperature Range	T_j, T_{STG}	-55 to +150							$^\circ\text{C}$

Note: 1. Measured with $I_F = 0.5\text{A}$, $I_R = 1.0\text{A}$, $I_{rr} = 0.25\text{A}$. See figure 5.
 2. Measured at 1.0 MHz and applied reverse voltage of 4.0 V DC.
 3. Mounted on P.C. Board with 8.0mm² land area.

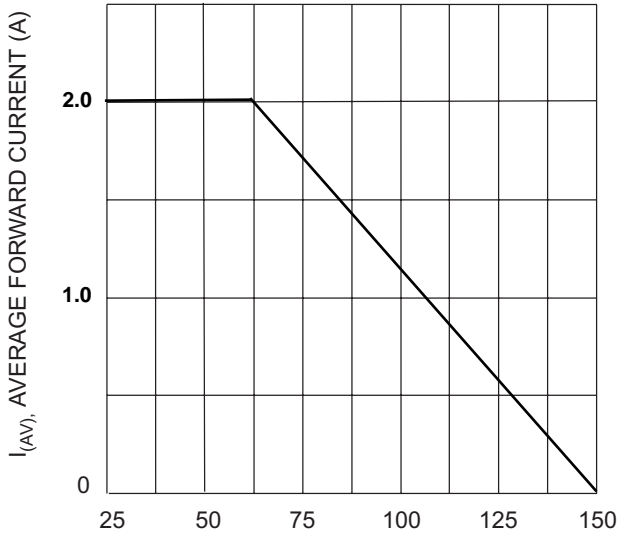

Fig. 1 Forward Current Derating Curve

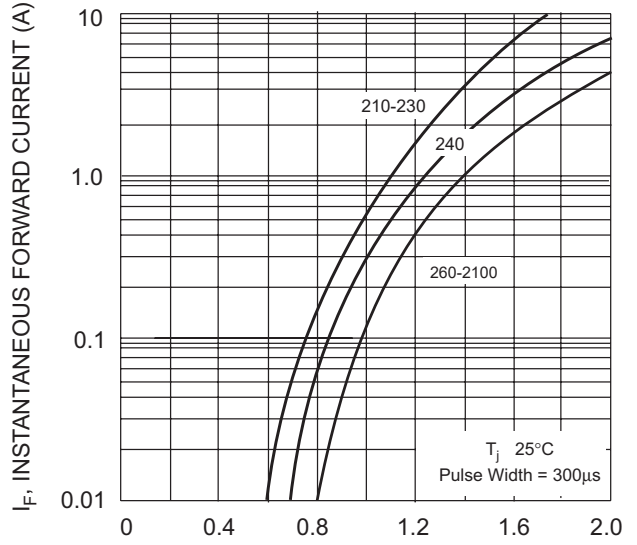

Fig. 2 Typical Forward Characteristics

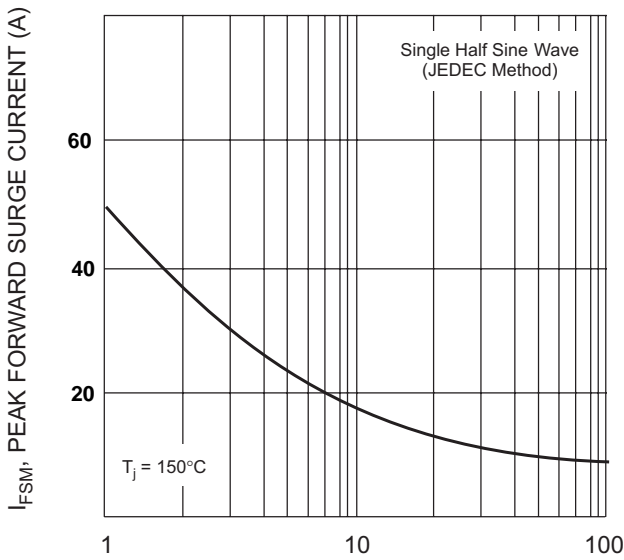

Fig. 3 Forward Surge Current Derating Curve

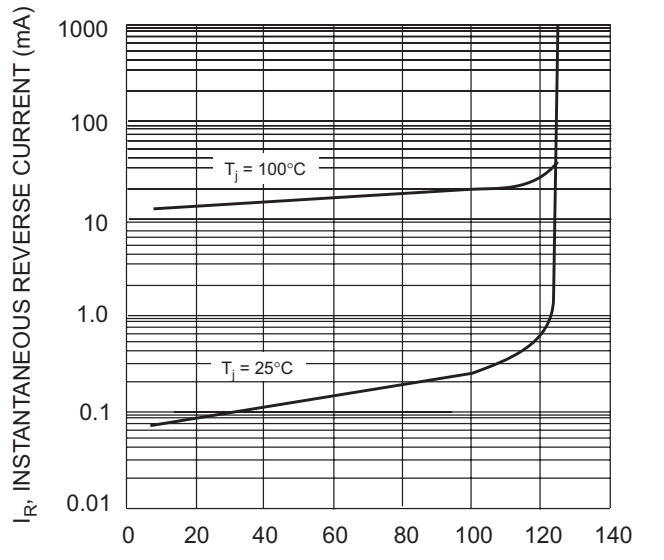
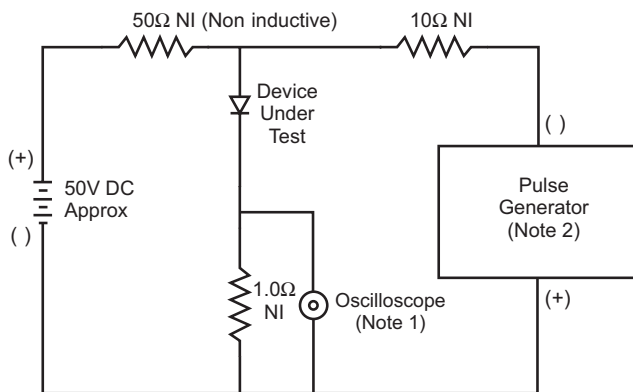
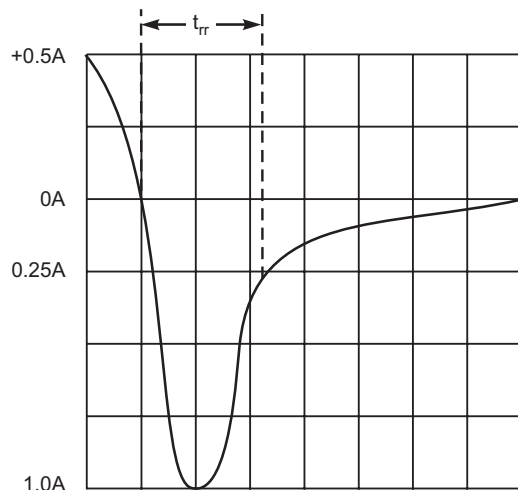

Fig. 4 Typical Reverse Characteristics



- Notes:
1. Rise Time = 7.0ns max. Input Impedance = 1.0MΩ, 22pF.
 2. Rise Time = 10ns max. Input Impedance = 50Ω.



Set time base for 10ns/cm

Fig. 5 Reverse Recovery Time Characteristic and Test Circuit