



Schottky Barrier Rectifiers
Reverse Voltage - 40 to 200 V
Forward Current - 40 A

Features

- High current capability
- Low forward voltage drop
- Low power loss, high efficiency
- High surge capability
- High temperature soldering guaranteed
- Mounting position: any

Mechanical data

- Case: TO-220-3L
- Approx Weight: 2.04g (0.07oz)
- Lead free finish, RoHS compliant
- Case Material: “Green” molding compound, UL flammability classification 94V-0, “Halogen-free”.

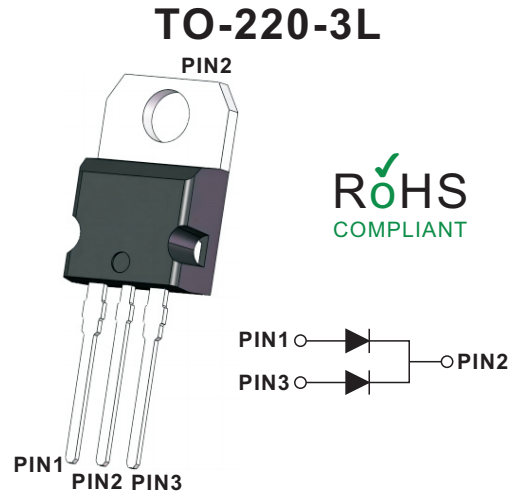

Packing Marking And Ordering Information

Device Package	Device	Marking	Packing Type	QTY Per Tube	Inner box	Per Carton
TO-220-3L	MBR40xxxCT	MBR40xxxCT	Tube	50 Pcs	2,500 Pcs	5,000 Pcs

Maximum Ratings And Electrical Characteristics

Ratings At 25°C Ambient Temperature Unless Otherwise Specified

Characteristics	Symbols	MBR 4040CT	MBR 4045CT	MBR 4060CT	MBR 40100CT	MBR 40150CT	MBR 40200CT	Units
Maximum Recurrent Peak Reverse Voltage	V_{RRM}	40	45	60	100	150	200	V
Maximum RMS voltage	V_{RMS}	28	32	42	70	105	140	V
Maximum DC Blocking Voltage	V_{DC}	40	45	60	100	150	200	V
Maximum Average Forward Rectified Current per leg per device	$I_{F(AV)}$	20			40			A
Peak Forward Surge Current, 8.3ms Single Half Sine-wave Superimposed on Rated Load (JEDEC method) per leg	I_{FSM}	250						A
Max Instantaneous Forward Voltage at 20A(per leg)	V_F	0.75		0.80	0.88	0.95		V
Maximum DC Reverse Current at Rated DC Reverse Voltage $T_a = 25^\circ C$ $T_a = 100^\circ C$	I_R	0.1			0.05			mA
Typical Thermal Resistance TO-220 ITO-220	$R_{\theta JC}$	2			4			°C/W
Operating Junction Temperature Range	T_j	-55 ~ +150				-55 ~ +175		°C
Storage Temperature Range	T_{stg}	-55 ~ +150				-55 ~ +175		°C



Fig.1 Typical Forward Current Derating Curve

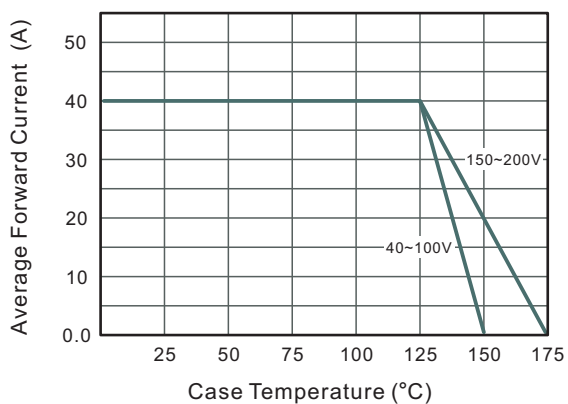

Fig.2 Typical Reverse Characteristics

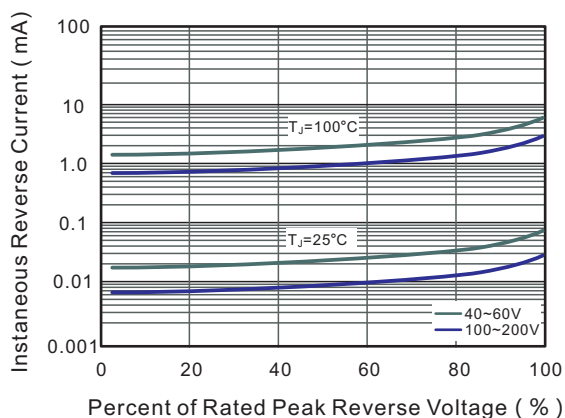

Fig.3 Typical Forward Characteristic(per leg)

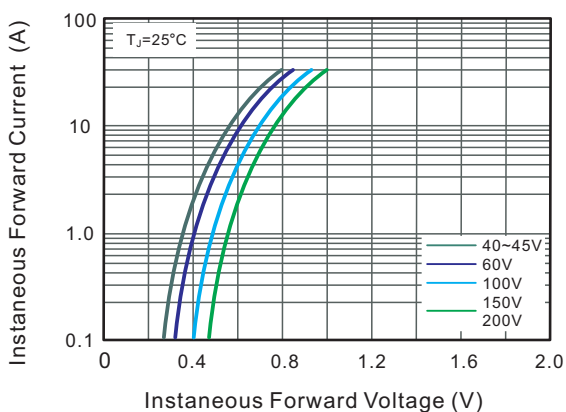
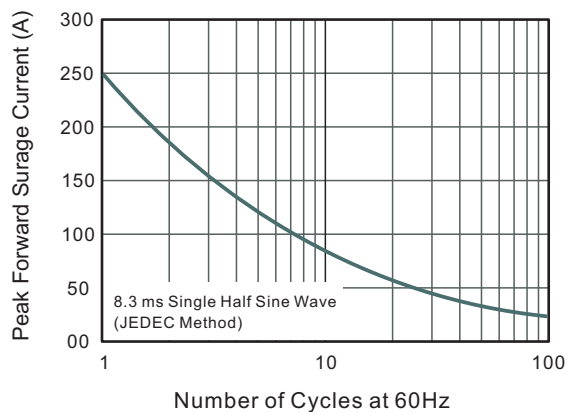

Fig.4 Maximum Non-Repetitive Peak Forward Surge Current





Package Outline
Through Hole Package ; 3 leads

TO-220-3L

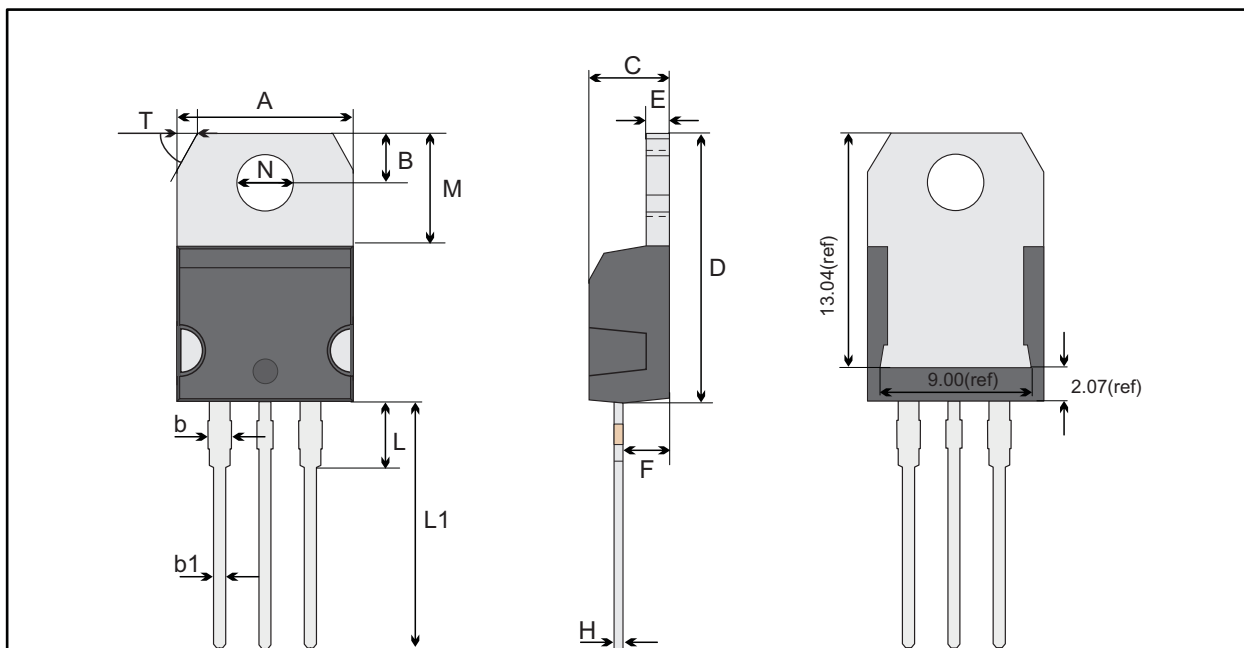

TO-220-3L mechanical data

UNIT		A	B	b	b1	C	D	E	F	G	H	L	L1	M	N	T
mm	max	10.28	2.84	1.67	0.9	4.65	15.54	1.37	2.79	2.64	0.6	3.88	13.13	6.39	3.82 typ.	1.19 58° ref.
	typ	10.18	2.74	1.47	0.8	4.45	15.34	1.27	2.59	2.54	0.5	3.68	12.93	6.19		
	min	10.08	2.64	1.27	0.7	4.25	15.14	1.17	2.39	2.44	0.4	3.48	12.73	5.99		
mil	max	405	112	66	35	183	612	54	110	104	24	153	517	252	150 typ.	47 58° ref.
	typ	401	108	58	31	175	604	50	102	100	20	145	509	244		
	min	397	104	50	28	167	596	46	94	92	16	137	501	236		

Marking Diagram

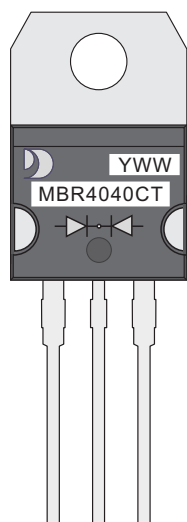

YWW: Date Code
 Y: Years(0~9)
 WW: Week
 MBR4040CT: Product name
 (NOTE: The weekly code is based on the actual number of weeks in the calendar year.)



Important Notice and Disclaimer

Jingdao Microelectronics reserves the right to make changes to this document and its products and specifications at any time without notice. Customers should obtain and confirm the latest product information and specifications before final design, purchase or use.

Jingdao Microelectronics makes no warranty, representation or guarantee regarding the suitability of its products for any particular purpose, not does Jingdao Microelectronics assume any liability for application assistance or customer product design.

Jingdao Microelectronics does not warrant or accept any liability with products which are purchased or used for any unintended or unauthorized application.

No license is granted by implication or otherwise under any intellectual property rights of Jingdao Microelectronics.

Jingdao Microelectronics products are not authorized for use as critical components in life support devices or systems without express written approval of Jingdao Microelectronics.