

## SCHOTTKY BARRIER RECTIFIERS

### FEATURES

- High current rectifier Schottky diodes
- Low voltage, low inductance
- For detection and step-up-conversion

### MECHANICAL DATA

- Case: SOD-323
- Terminals: Solderable per MIL-STD-750, Method 2026
- Approx. Weight: 5.48mg / 0.00019oz

### PINNING

PIN	DESCRIPTION
1	Cathode
2	Anode



Top View  
 Marking Code: W5  
 Simplified outline SOD-323 and symbol

### Maximum Ratings at 25 °C

Parameter	Symbols	BAT60B	Units
Non-repetitive Peak Reverse Voltage	$V_{RRM}$	10	V
Forward Current	$I_F$	3	A
Forward Surge Current at 8.3ms	$I_{FSM}$	20	A
Power Dissipation at $T_c=25^\circ\text{C}$	$P_D$	350	mW
Operating and Storage Temperature Range	$T_j, T_{stg}$	-55 ~ +150	$^\circ\text{C}$

### ELECTRICAL CHARACTERISTICS ( $T_a=25^\circ\text{C}$ unless otherwise specified)

Parameter	Symbols	BAT60B	Units
Maximum Forward Voltage $I_F=10\text{ mA}$ $I_F=100\text{ mA}$ $I_F=500\text{ mA}$ $I_F=1000\text{ mA}$	$V_F$	0.30 0.38 0.50 0.60	V
Peak Reverse Current $V_{R1}=5\text{V}$ $V_{R2}=8\text{V}$	$I_R$	15 20	$\mu\text{A}$
Diodes Capacitance $V_R=5\text{V}, f=1\text{MHz}$	$C_T$	30	pF

**Fig.1 Power Derating Curve**

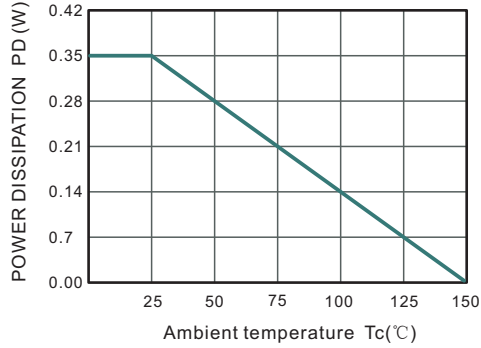

**Fig.2 Typical Reverse Characteristics**

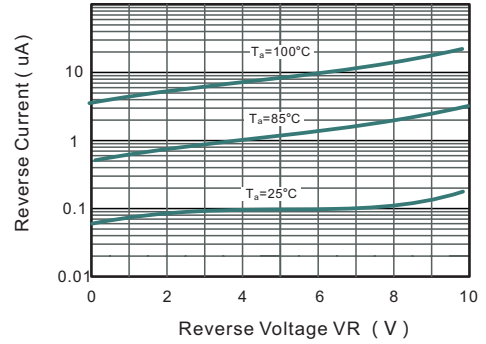

**Fig.3 Typical Junction Capacitance**

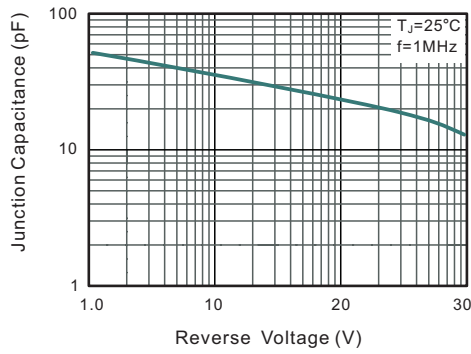

**Fig.4 Typical Forward Characteristic**

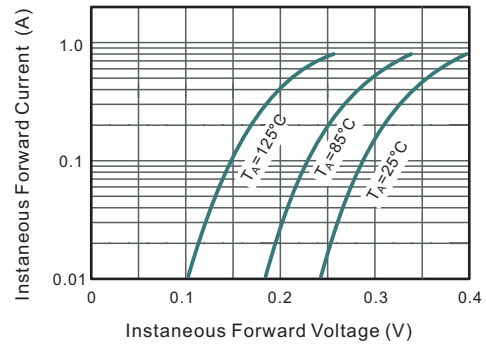

**Fig.5 Maximum Non-Repetitive Peak Forward Surge Current**

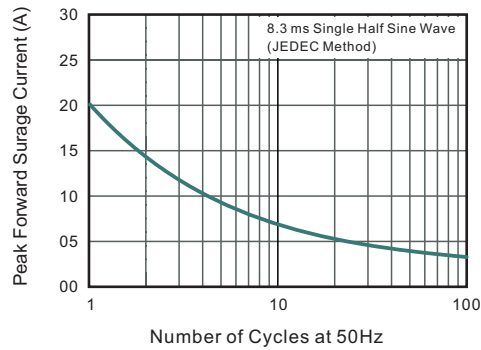

**PACKAGE OUTLINE**

Plastic surface mounted package; 2 leads

**SOD-323**

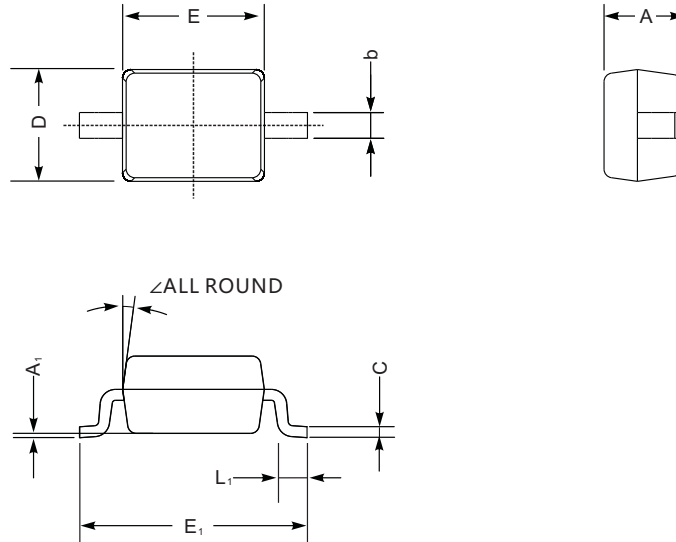

**SOD-323 mechanical data**

UNIT		A	C	D	E	E <sub>1</sub>	b	L <sub>1</sub>	A <sub>1</sub>	∠
mm	max	1.1	0.15	1.4	1.8	2.75	0.4	0.45	0.2	9°
	min	0.8	0.08	1.2	1.4	2.55	0.25	0.2	—	
mil	max	43	5.9	55	70	108	16	16	8	
	min	32	3.1	47	63	100	9.8	7.9	—	

**The recommended mounting pad size**

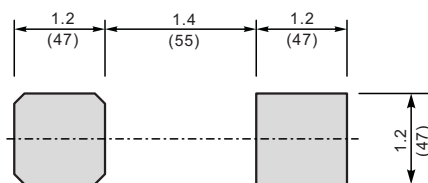

Unit:  $\frac{\text{mm}}{\text{(mil)}}$