

AVX

A KYOCERA GROUP COMPANY



AVX Tantalum and Niobium Oxide Capacitors

<Version 6.1>

Introduction

AVX Tantalum



APPLICATIONS

		
2-16 Volt Low ESR Low Profile Case 0603 available Low Failure Rate High Volumetric Efficiency Temperature Stability Stable over Time	50 Volt @ 85°C 33 Volt @ 125°C Automotive Range High Reliability Temperature Stability QS9000 Approved TS 16949 Plant Approved Up to 150°C AEC Q200 Approval	2 - 16 Volts Low ESR World's Smallest Tantalum 0402 Available High Volumetric Efficiency Low Profile Versions

QUALITY STATEMENTS

AVX's focus is CUSTOMER satisfaction - customer satisfaction in the broadest sense: product quality, technical support, product availability - all at a competitive price.

In pursuance of the established goals of our corporate wide QV2000 program, it is the stated objective of AVX Tantalum to supply our customers with a world class service in the manufacture and supply of electronic components, while maintaining a positive return on investment.

This world class service shall be defined as consistently supplying product and services of the highest quality and reliability encompassing all aspects of the customer supply chain.

In addition, any new or changed products, processes or services will be qualified to established standards of quality and reliability.

The objectives and guidelines listed above shall be achieved by the following codes of practice:

1. Continual objective evaluation of customer needs and expectations for the future and the leverage of all AVX resources to meet this challenge.

2. Continually fostering and promoting a culture of continuous improvement through ongoing training and empowered participation of employees at all levels of the company.

3. Continuous Process Improvement using sound engineering principles to enhance existing equipment, material and processes. This includes the application of the science of S.P.C. focused on improving the Process Capability Index, Cpk.

The Tantalum division has plants approved to ISO9001:2000 and TS16949:2002 (Automotive Quality System Requirements) with the intention that all facilities world-wide will adopt this as the quality standard.

Dedicated series of tantalum and niobium oxide capacitors meets requirements of AEC-Q200.

The Tantalum division has plants approved to ISO14001 with the intention that all facilities world-wide will adopt this as the quality standard.



Introduction



AVX Tantalum

AVX Paignton UK is the Divisional Headquarters for the Tantalum division which has manufacturing locations in Paignton in the UK, Biddeford in Maine, USA, Juarez in Mexico, Lanskrout in the Czech Republic, San Salvador, in El Salvador and Tianjin in P.R. China.

This division manufactures tantalum and niobium oxide capacitors. Tantalum is an element extracted from ores found alongside tin and niobium deposits; the major sources of supply are Canada, Brazil and Australasia.

TECHNOLOGY TRENDS

The amount of capacitance possible in a tantalum capacitor is directly related to the type of tantalum powder used to manufacture the anode.

The graph following shows how the (capacitance) x (voltage) per gram (CV/g) has steadily increased over time, thus allowing the production of larger and larger capacitances with the same physical volume. CV/g is the measure used to define the volumetric efficiency of a powder, a high CV/g means a higher capacitance from the same volume.

These powder improvements have been achieved through close development with the material suppliers. AVX Tantalum is committed to driving the available technology forward as is clearly demonstrated by extended ratings continually being developed, and new technologies such as TACmicrochip™ and OxiCap™ technology.

If you have any specific requirements, please contact your local AVX sales office for details on how AVX Tantalum can assist you in addressing your future requirements.

WORKING WITH THE CUSTOMER - ONE STOP SHOPPING

In line with our desire to become the number one supplier in the world for passive and interconnection components, AVX is constantly looking forward and innovating.

It is not good enough to market the best products; the customer must have access to a service system which suits their needs and benefits their business.

The AVX 'one stop shopping' concept is already beneficial in meeting the needs of major OEMs while worldwide partnerships with only the premier division of distributors aids the smaller user.

Helping to market and support our customers across the breadth and depth of our electronic component line card are a dedicated team of sales engineers, applications engineers

Niobium oxide is a ceramic material that can be processed to the same powder form as traditional tantalum capacitors and manufactured in an identical process.

So for high volume tantalum and niobium oxide capacitors with leading edge technology call us first - **AVX your global partner.**

Niobium oxide capacitors have been assigned the OxiCap™ trademark.

Tantalum Powder CV/gm

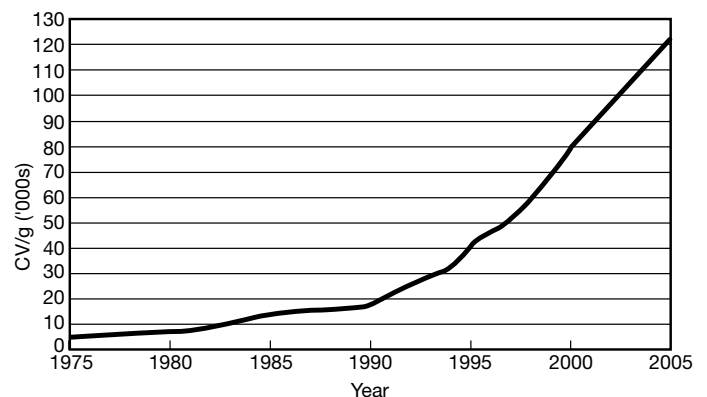

and product marketing managers. Their qualifications are hopefully always appropriate to your commercial needs, but as higher levels of technical expertise are required, access directly to the appropriate department is seamless and transparent.

Total quality starts and finishes with our commitment to customer service. Where cost and quality are perceived as given quantities AVX's first in class service invariably places us in the top rank of any preferred supplier list.

Facilities are equipped with instant worldwide DP and telecommunication links connected to every sales and production site worldwide. That ensures our customers' delivery requirements are consistently met wherever in the world they may be.

*Niobium Oxide Capacitors are manufactured and sold under patent license from Cabot Corporation, Boyertown, Pennsylvania U.S.A.



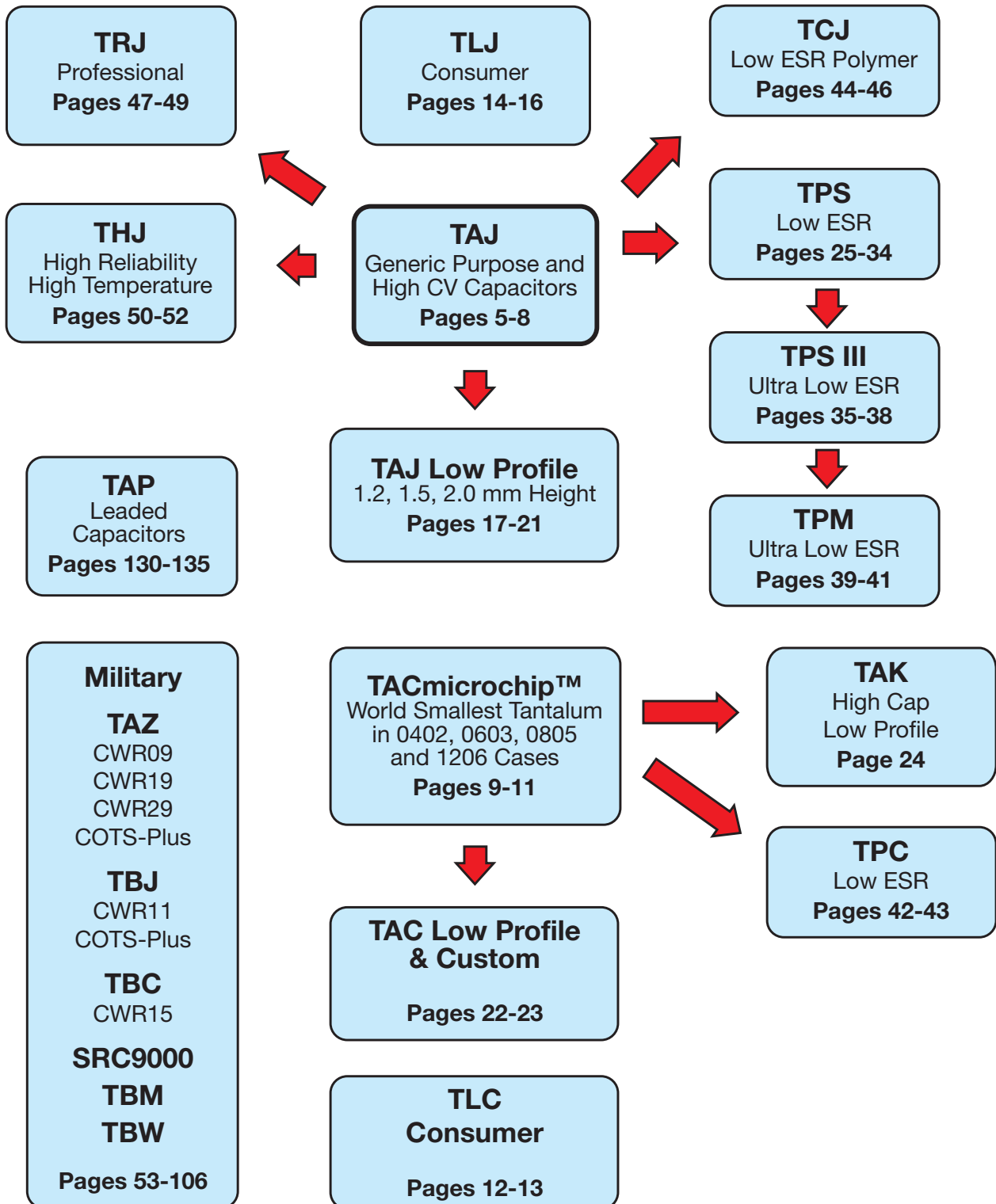

TAJ Series



Standard Tantalum



The TAJ standard series encompasses the five key sizes recognized by major OEMs throughout the world. The V case size has been added to the TAJ range to allow high CVs to be offered. The

operational temperature is -55°C to $+85^{\circ}\text{C}$ rated voltage and up to $+125^{\circ}\text{C}$ with voltage derating in applications utilizing recommended series resistance.

CASE DIMENSIONS: millimeters (inches)

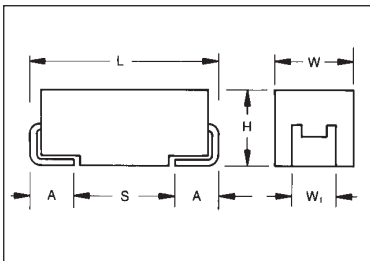

For part marking see page 164

Code	EIA Code	$L \pm 0.20$ (0.008)	$W \pm 0.20$ (0.008) -0.10 (0.004)	$H \pm 0.20$ (0.008) -0.10 (0.004)	$W_1 \pm 0.20$ (0.008)	$A \pm 0.30$ (0.012) -0.20 (0.008)	S Min.
A	3216-18	3.20 (0.126)	1.60 (0.063)	1.60 (0.063)	1.20 (0.047)	0.80 (0.031)	1.10 (0.043)
B	3528-21	3.50 (0.138)	2.80 (0.110)	1.90 (0.075)	2.20 (0.087)	0.80 (0.031)	1.40 (0.055)
C	6032-28	6.00 (0.236)	3.20 (0.126)	2.60 (0.102)	2.20 (0.087)	1.30 (0.051)	2.90 (0.114)
D	7343-31	7.30 (0.287)	4.30 (0.169)	2.90 (0.114)	2.40 (0.094)	1.30 (0.051)	4.40 (0.173)
E	7343-43	7.30 (0.287)	4.30 (0.169)	4.10 (0.162)	2.40 (0.094)	1.30 (0.051)	4.40 (0.173)
V	7361-38	7.30 (0.287)	6.10 (0.240)	3.45 ± 0.30 (0.136 ± 0.012)	3.10 (0.120)	1.40 (0.055)	4.40 (0.173)

W_1 dimension applies to the termination width for A dimensional area only.

HOW TO ORDER

TAJ

Type

C

Case Size
See table above

106

Capacitance Code
pF code: 1st two digits represent significant figures
3rd digit represents multiplier (number of zeros to follow)

M

Tolerance
 $K = \pm 10\%$
 $M = \pm 20\%$

035

Rated DC Voltage
002=2.5Vdc
004=4Vdc
006=6.3Vdc
010=10Vdc
016=16Vdc
020=20Vdc
025=25Vdc
035=35Vdc
050=50Vdc

R

Packaging

R = 7" T/R
(Lead Free since production date 1/1/04)
S = 13" T/R
(Lead Free since production date 1/1/04)
A = Gold Plating 7" Reel
B = Gold Plating 13" Reel
H = Tin Lead 7" Reel
K = Tin Lead 13" Reel

Additional characters may be added for special requirements

TECHNICAL SPECIFICATIONS

Technical Data:

All technical data relate to an ambient temperature of $+25^{\circ}\text{C}$

Capacitance Range:

0.1 μF to 2200 μF

Capacitance Tolerance:

$\pm 10\%$; $\pm 20\%$

Rated Voltage (V_R)

$\leq +85^{\circ}\text{C}$: 2.5 4 6.3 10 16 20 25 35 50

Category Voltage (V_C)

$\leq +125^{\circ}\text{C}$: 1.7 2.7 4 7 10 13 17 23 33

Surge Voltage (V_S)

$\leq +85^{\circ}\text{C}$: 3.3 5.2 8 13 20 26 32 46 65

Surge Voltage (V_S)

$\leq +125^{\circ}\text{C}$: 2.2 3.4 5 8 13 16 20 28 40

Temperature Range:

-55°C to $+125^{\circ}\text{C}$

Reliability:

1% per 1000 hours at 85°C , V_R with $0.1\Omega/V_R$ series impedance, 60% confidence level

Qualification:

CECC 30801 - 005 issue 2
EIA 535BAAC

Meets requirements of AEC-Q200



CAPACITANCE AND RATED VOLTAGE, V_R (VOLTAGE CODE) RANGE (LETTER DENOTES CASE SIZE)

Capacitance		Rated voltage DC (V_R) to 85°C								
μF	Code	2.5V (e)	4V (G)	6.3V (J)	10V (A)	16V (C)	20V (D)	25V (E)	35V (V)	50V (T)
0.10	104								A	A
0.15	154								A	A/B
0.22	224								A	A/B
0.33	334								A	B
0.47	474							A	A/B	A/B/C
0.68	684						A	A	A/B	A/B/C
1.0	105					A	A	A	A/B	A ^(M) /B/C
1.5	155				A	A	A	A/B	A/B/C	C/D
2.2	225			A	A	A/B	A/B	A/B	A/B/C	C/D
3.3	335			A	A	A/B	A/B	A/B/C	B/C	C/D
4.7	475		A	A	A/B	A/B	A/B/C	A/B/C	B/C/D	D
6.8	685		A	A/B	A/B	A/B/C	A/B/C	B/C	C/D	D
10	106		A	A/B	A/B/C	A/B/C	B/C	C/D	C/D/E	D/E/V
15	156		A/B	A/B	A/B/C	A ^(M) /B/C	B/C/D	C/D	C/D	D/E/V
22	226		A	A/B/C	A/B/C	B/C/D	B/C/D	C/D	D/E	V
33	336	A	A/B	A/B/C	A/B/C/D	B/C/D	C/D	D/E	D/E/V	
47	476	A	A/B	A/B/C/D	B/C/D	C/D	C/D/E	D/E	D/E	
68	686	A	A/B/C	B/C/D	B/C/D	C/D	D/E	E/V	E/V	V ^(M)
100	107	A/B	A/B/C	B/C/D	B ^(M) /C/D/E	D/E	D/E/V	V		
150	157	B	B/C	C/D	C/D/E	D/E/V	E/V			
220	227	B/D	B ^(M) /C/D	C/D/E	D/E	D/E/V	D/E/V			
330	337	D	C/D/E	C/D/E	D/E/V	E/V				
470	477	C/D	D/E	D/E/V	E/V	V				
680	687	D/E	D/E	E/V						
1000	108	D ^(M) /E	D/E/V	V ^(M)						
1500	158	D/E/V	E/V ^(M)							
2200	228	V								

Non preferred Ratings - not recommended for new designs, higher voltage or smaller case size substitution are offered.

Developmental Ratings - subject to change.

Released codes ^(M tolerance only)

Note: Voltage ratings are minimum values. AVX reserves the right to supply higher ratings in the same case size, to the same reliability standards.

TAJ Series



Standard Tantalum

RATINGS & PART NUMBER REFERENCE

AVX Part No.	Case Size	Capacitance (µF)	Rated Voltage (V)	DCL (µA) Max.	DF % Max.	ESR Max. (Ω) @100kHz
TAJA476*002#	A	47	2.5	0.9	6	3
TAJA686*002#	A	68	2.5	1.4	8	1.5
TAJA107*002#	A	100	2.5	2.5	30	1.4
TAJB107*002#	B	100	2.5	2.5	8	1.4
TAJB157*002#	B	150	2.5	3	10	1.6
TAJB227*002#	B	220	2.5	4.4	16	1.6
TAJD227*002#	D	220	2.5	5.5	8	0.3
TAJD337*002#	D	330	2.5	8.2	8	0.3
TAJC477*002#	C	470	2.5	9.4	12	0.2
TAJD477*002#	D	470	2.5	11.6	8	0.2
TAJD687*002#	D	680	2.5	17	16	0.2
TAJE687*002#	E	680	2.5	17	10	0.2
TAJD108M002#	D	1000	2.5	25	20	0.2
TAJE108*002#	E	1000	2.5	20	14	0.4
TAJD158*002#	D	1500	2.5	37.5	60	0.2
TAJE158*002#	E	1500	2.5	37	20	0.2
TAJV158*002#	V	1500	2.5	30	20	0.2
TAJV228*002#	V	2200	2.5	55	50	0.2
TAJA336*004#	A	33	4	1.3	6	3
TAJA476*004#	A	47	4	1.9	8	2.6
TAJA686*004#	A	68	4	2.7	10	1.5
TAJB686*004#	B	68	4	2.7	6	1.8
TAJA107*004#	A	100	4	4	30	1.4
TAJB107*004#	B	100	4	4	8	0.9
TAJB157*004#	B	150	4	6	8	1.5
TAJC157*004#	C	150	4	6	6	0.3
TAJB227M004#	B	220	4	8.8	12	1.1
TAJC227*004#	C	220	4	8.8	8	1.2
TAJD227*004#	D	220	4	8.8	8	0.9
TAJC337*004#	C	330	4	13.2	8	0.9
TAJD337*004#	D	330	4	13.2	8	0.9
TAJD477*004#	D	470	4	18.8	12	0.9
TAJE477*004#	E	470	4	18.8	10	0.5
TAJD687*004#	D	680	4	27.2	14	0.5
TAJE687*004#	E	680	4	27.2	14	0.9
TAJD108*004#	D	1000	4	40	60	0.2
TAJE108*004#	E	1000	4	40	14	0.4
TAJV108*004#	V	1000	4	40	16	0.4
TAJE158*004#	E	1500	4	60	30	0.2
TAJV158M004#	V	1500	4	60	30	0.2
TAJA106*006#	A	10	6.3	0.6	6	4
TAJA156*006#	A	15	6.3	0.9	6	3.5
TAJA226*006#	A	22	6.3	1.4	6	3
TAJA336*006#	A	33	6.3	2.1	8	2.5
TAJA476*006#	A	47	6.3	2.8	10	1.6
TAJB476*006#	B	47	6.3	3	6	2
TAJC476*006#	C	47	6.3	3	6	1.6
TAJB686*006#	B	68	6.3	4	8	0.9
TAJC686*006#	C	68	6.3	4.3	6	1.5
TAJB107*006#	B	100	6.3	6.3	10	1.7
TAJC107*006#	C	100	6.3	6.3	6	0.9
TAJC157*006#	C	150	6.3	9.5	6	1.3
TAJD157*006#	D	150	6.3	9.5	6	0.9
TAJC227*006#	C	220	6.3	13.9	8	1.2
TAJD227*006#	D	220	6.3	13.9	8	0.9
TAJE227*006#	E	220	6.3	13.9	8	0.9
TAJD337*006#	D	330	6.3	20.8	8	0.4
TAJE337*006#	E	330	6.3	20.8	8	0.4
TAJD477*006#	D	470	6.3	28	12	0.4
TAJE477*006#	E	470	6.3	28	10	0.4

AVX Part No.	Case Size	Capacitance (µF)	Rated Voltage (V)	DCL (µA) Max.	DF % Max.	ESR Max. (Ω) @100kHz
TAJV477*006#	V	470	6.3	28	10	0.4
TAJE687*006#	E	680	6.3	42.8	10	0.5
TAJV687*006#	V	680	6.3	42.8	10	0.5
TAJV108M006#	V	1000	6.3	63	16	0.4
TAJA475*010#	A	4.7	10	0.5	6	5
TAJA685*010#	A	6.8	10	0.7	6	4
TAJA106*010#	A	10	10	1	6	3
TAJA156*010#	A	15	10	1.5	6	3.2
TAJB156*010#	B	15	10	1.5	6	2.8
TAJA226*010#	A	22	10	2.2	8	3
TAJB226*010#	B	22	10	2.2	6	2.4
TAJA336*010#	A	33	10	3.3	8	1.7
TAJB336*010#	B	33	10	3.3	6	1.8
TAJC336*010#	C	33	10	3.3	6	1.6
TAJB476*010#	B	47	10	4.7	8	1
TAJC476*010#	C	47	10	4.7	6	1.2
TAJB686*010#	B	68	10	6.8	6	1.4
TAJC686*010#	C	68	10	6.8	6	1.3
TAJB107M010#	B	100	10	10	8	1.4
TAJC107*010#	C	100	10	10	8	1.2
TAJD107*010#	D	100	10	10	6	0.9
TAJC157*010#	C	150	10	15	8	0.9
TAJD157*010#	D	150	10	15	6	0.9
TAJE157*010#	E	150	10	15	8	0.9
TAJD227*010#	D	220	10	22	8	0.5
TAJE227*010#	E	220	10	22	8	0.5
TAJD337*010#	D	330	10	33	8	0.9
TAJE337*010#	E	330	10	33	8	0.9
TAJV337*010#	V	330	10	33	10	0.9
TAJE477*010#	E	470	10	47	10	0.5
TAJV477*010#	V	470	10	47	10	0.5
TAJA225*016#	A	2.2	16	0.5	6	6.5
TAJA335*016#	A	3.3	16	0.5	6	5
TAJB335*016#	B	3.3	16	0.5	6	4.5
TAJA475*016#	A	4.7	16	0.8	6	4
TAJB475*016#	B	4.7	16	0.8	6	3.5
TAJA685*016#	A	6.8	16	1.1	6	3.5
TAJB685*016#	B	6.8	16	1.1	6	2.5
TAJA106*016#	A	10	16	1.6	8	3
TAJB106*016#	B	10	16	1.6	6	2.8
TAJC106*016#	C	10	16	1.6	6	2
TAJA156M016#	A	15	16	2.4	6	2
TAJB156*016#	B	15	16	2.4	6	2.5
TAJC156*016#	C	15	16	2.4	6	1.8
TAJB226*016#	B	22	16	3.5	6	2.3
TAJC226*016#	C	22	16	3.5	6	1.6
TAJD226*016#	D	22	16	3.5	6	1.1
TAJB336*016#	B	33	16	5.3	8	2.1
TAJC336*016#	C	33	16	5.3	6	1.5
TAJD336*016#	D	33	16	5.3	6	0.9
TAJC476*016#	C	47	16	7.5	6	1.4
TAJD476*016#	D	47	16	7.5	6	0.9
TAJC686*016#	C	68	16	10.9	6	1.3
TAJD686*016#	D	68	16	10.9	6	0.9
TAJD107*016#	D	100	16	16	6	0.9
TAJE107*016#	E	100	16	16	6	0.9
TAJD157*016#	D	150	16	24	6	0.9
TAJE157*016#	E	150	16	24	8	0.3
TAJV157*016#	V	150	16	24	8	0.5
TAJE227*016#	E	220	16	35.2	10	0.5

All technical data relates to an ambient temperature of +25°C. Capacitance and DF are measured at 120Hz, 0.5V RMS with a maximum DC bias of 2.2 volts. DCL is measured at rated voltage after 5 minutes.

- * Insert K for ±10% and M for ±20% Capacitance Tolerance
- # **Standard Plating** – Insert R for 7" reel and S for 13" reel
- # **Gold Plating** – Insert A for 7" reel and B for 13" reel
- # **Tin Lead Plating** – Insert H for 7" reel and K for 13" reel

NOTE: AVX reserves the right to supply a higher voltage rating or tighter tolerance part in the same case size, to the same reliability standards.



TLJ Series



Tantalum Solid Electrolytic Chip Capacitors High CV Consumer Series

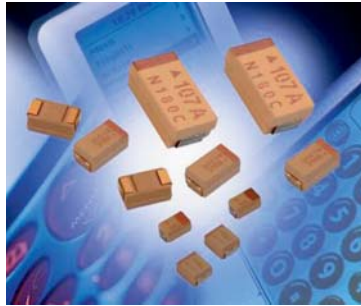

The consumer TLJ series of tantalum capacitors offers high capacitance vs. voltage ratio based on stable MnO₂ electrode capacitors. The TLJ series complies with RoHS requirements and it is an environmentally friendly component ready for lead-free assembly systems up to 3x reflow with 260°C peak temperature. The TLJ series is suitable for wide range of consumer electronic applications such as the latest portable handheld electronics, cellular phones, PDAs or other digital equipment and cameras.

- High Volumetric Efficiency
- Environmentally Friendly
- Small & Low Profile Cases
- 3x Reflow 260°C Compatible
- Consumer Applications



LEAD-FREE
LEAD-FREE COMPATIBLE
COMPONENT

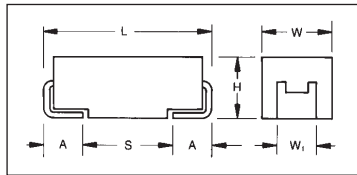

For part marking see page 164

CASE DIMENSIONS: millimeters (inches)

Code	EIA Code	L±0.20 (0.008)	W+0.20 (0.008) -0.10 (0.004)	H+0.20 (0.008) -0.10 (0.004)	W ₁ ±0.20 (0.008)	A+0.30 (0.012) -0.20 (0.008)	S Min.
A	3216-18	3.20 (0.126)	1.60 (0.063)	1.60 (0.063)	1.20 (0.047)	0.80 (0.031)	1.80 (0.071)
B	3528-21	3.50 (0.138)	2.80 (0.110)	1.90 (0.075)	2.20 (0.087)	0.80 (0.031)	1.40 (0.055)
G	3216	3.20 (0.126)	1.60 (0.063)	1.50 (0.059) max	1.20 (0.047)	0.80 (0.031)	1.10 (0.043)
H	3528-12	3.50 (0.138)	2.80 (0.110)	1.50 (0.059) max	2.20 (0.087)	0.80 (0.031)	1.40 (0.055)
J	1608-09	1.60 (0.063)	0.80 (0.032)	0.90 (0.035)	0.60 (0.023)	0.30 (0.012)	0.55 (0.021)
K	3216	3.20 (0.126)	1.60 (0.063)	1.0 (0.039)	1.20 (0.047)	0.80 (0.031)	1.10 (0.043)
P	2012-15	2.05 (0.081)	1.35 (0.053)	1.50 (0.059) max	1.0±0.1 (0.039±0.004)	0.50 (0.020)	0.85 (0.033)
R	2012-12	2.05 (0.081)	1.30 (0.051)	1.20 (0.047) max	1.0±0.1 (0.039±0.004)	0.50 (0.020)	0.70 (0.028)
S	3216-12	3.20 (0.126)	1.60 (0.063)	1.20 (0.047) max	1.20 (0.047)	0.80 (0.031)	1.10 (0.043)
T	3528-12	3.50 (0.138)	2.80 (0.110)	1.20 (0.047) max	2.20 (0.087)	0.80 (0.031)	2.00 (0.079)
W	6032-15	6.00 (0.236)	3.20 (0.126)	1.50 (0.059) max	2.20 (0.087)	1.30 (0.051)	2.90 (0.114)

W₁ dimension applies to the termination width for A dimensional area only.

HOW TO ORDER

TLJ

Type

W

Case Size
See table above

157

Capacitance Code
pF code: 1st two digits represent significant figures, 3rd digit represents multiplier (number of zeros to follow)

M

Tolerance
M=±20%

010

Rated DC Voltage
002=2.5Vdc
004=4Vdc
006=6.3Vdc
010=10Vdc
016=16Vdc

R

Packaging
R=7" T/R
S=13" T/R

0200

ESR in mΩ

TECHNICAL SPECIFICATIONS

Technical Data:

All technical data relate to an ambient temperature of +25°C

Capacitance Range:

10 μF to 220 μF

Capacitance Tolerance:

±20%

Rated Voltage (V_R)

-55°C ≤ +40°C:

2.5 4 6.3 10 16

Category Voltage (V_C)

at 85°C:

1.25 2 3.15 5 8

Category Voltage (V_C)

at 125°C:

0.5 0.8 1.26 2 3.2

Temperature Range:

-55°C to +125°C with category voltage

Reliability:

0.2% per 1000 hours at 85°C, 0.5xV_R, with 0.1Ω/V series impedance with 60% confidence level



TLJ Series



Tantalum Solid Electrolytic Chip Capacitors High CV Consumer Series

CAPACITANCE AND RATED VOLTAGE, V_R (VOLTAGE CODE) RANGE (LETTER DENOTES CASE SIZE)

Capacitance		Rated Voltage DC to 40°C / 0.5DC to 85°C / 0.2DC to 125°C					
μF	Code	2.5V (e)	4V (G)	6.3V (J)	10V (A)	16V (C)	35V (V)
1							
1.5							
2.2							P
3.3							
4.7				J(8500)	J(10000)		
6.8	685			J(10000)		R	
10	106			J(8000)	R(3000)	P	
15	156				R(2000)	P/S	
22	226		J	R(3500)	P	A/T(1000)	
33	336		R(3000)	K(1700)/(3000) R(3000)	P(3500)/R(3500) S(1500)	S/T	
47	476	R	K(1500)/P(3000) R(3000)	K(1500)/P(2500) S(1500)	A(600)/G(1500) P(3200)/S(1500) T(600)	B	
68	686	P	K(1200)/P(3000) S(1500)	A(500)/G(800) T(600)	A/T	B/W	
100	107	S	A(500)/G(800) S(1400)	A(500,800)/T(800)	H(900)/T	W	
150	157	A	A(800)/T(800)	H(900)/T(1200)	B(500)/W(200)		
220	227	A/T(1100)	H(900)/T(1100)	B(500)/W(200)			
330	337		B*/W(200)	B			
470	477	B*/W*	B*				

Red - Developmental Ratings - subject to change

Violet - Please Contact Manufacturer

Available Ratings, (ESR ratings in mOhms in brackets)



TLJ Series



Tantalum Solid Electrolytic Chip Capacitors High CV Consumer Series

RATINGS & PART NUMBER REFERENCE

AVX Part No.	Case Size	Capacitance (µF)	Rated Voltage (V)	Maximum Surge Current (A)*	DCL (µA) Max.	ESR Max. (mΩ) @100kHz	100kHz Ripple Current (mA)			100kHz Ripple Voltage (mV)		
							25°C	85°C	125°C	25°C	85°C	125°C
2.5 Volt @ 40°C (1.25V @ 85°C, 0.5V @ 125°C)												
TLJT227M002#1200	T	220	2.5	0.8	5.5	1100	365	329	146	219	197	88
4 Volt @ 40°C (2 Volt @ 85°C, 0.8 Volt @ 125°C)												
TLJR336M004#3000	R	33	4	0.6	1.3	3000	135	122	54	406	366	162
TLJK476M004#1500	K	47	4	1.0	1.9	1500	208	187	83	312	281	125
TLJP476M004#3000	P	47	4	0.6	1.9	3000	141	127	57	424	382	170
TLJR476M004#3000	R	47	4	0.6	1.9	3000	135	122	54	406	366	162
TLJK686M004#1200	K	68	4	1.2	2.7	1200	233	209	93	279	251	112
TLJP686M004#3000	P	68	4	1.2	2.7	3000	141	127	57	424	382	170
TLJS686M004#1500	S	68	4	1.0	2.7	1500	208	187	83	312	281	125
TLJA107M004#0500	A	100	4	2.1	4.0	500	387	349	155	194	174	77
TLJG107M004#0800	G	100	4	1.6	4.0	800	296	266	118	237	213	95
TLJS107M004#1400	S	100	4	1.1	4.0	1400	208	187	83	312	281	125
TLJA157M004#0800	A	150	4	1.6	6.0	800	306	276	122	245	220	98
TLJT157M004#0800	T	150	4	1.6	6.0	800	316	285	126	253	228	101
TLJH227M004#0900	H	220	4	1.5	8.8	900	298	268	119	268	241	107
TLJT227M004#1100	T	220	4	1.3	8.8	1100	316	285	126	253	228	101
TLJW337M004#0200	W	330	4	3.1	13.2	200	671	604	268	134	121	54
6.3 Volt @ 40C (3.15V @ 85C, 1.26V @ 125C)												
TLJJ475M006#KJ	J	4.7	6.3	0.4	0.5	8500	34	31	14	292	262	117
TLJJ685M006#KJ	J	6.8	6.3	0.3	0.5	10000	32	28	13	316	285	126
TLJJ106M006#KJ	J	10	6.3	0.4	0.6	8000	35	32	14	283	255	113
TLJR226M006#3500	R	22	6.3	0.8	1.3	3500	125	113	50	439	395	175
TLJK336M006#1700	K	33	6.3	1.5	2.0	1700	196	176	78	332	299	133
TLJP336M006#3000	P	33	6.3	0.9	2.0	3000	141	127	57	424	382	170
TLJR336M006#3000	R	33	6.3	0.9	2.0	3000	135	122	54	406	366	162
TLJK476M006#1500	K	47	6.3	1.6	2.8	1500	208	187	83	312	281	125
TLJP476M006#2500	P	47	6.3	1.1	2.8	2500	155	139	62	387	349	155
TLJS476M006#1500	S	47	6.3	1.6	2.8	1500	208	187	83	312	281	125
TLJA686M006#0500	A	68	6.3	3.3	4.1	500	387	349	155	194	174	77
TLJG686M006#0800	G	68	6.3	1.9	4.1	800	242	217	97	290	261	116
TLJT686M006#0600	T	68	6.3	3.0	4.1	600	365	329	146	219	197	88
TLJA107M006#0500	A	100	6.3	3.3	6.0	500	387	349	155	194	174	77
TLJA107M006#0800	A	100	6.3	2.5	6.0	800	306	276	122	245	220	98
TLJT107M006#0800	T	100	6.3	2.5	6.0	800	316	285	126	253	228	101
TLJH157M006#0900	H	150	6.3	2.3	9.0	900	298	268	119	268	241	107
TLJT157M006#1200	T	150	6.3	1.9	9.0	1200	316	285	126	253	228	101
TLJB227M006#0500	B	220	6.3	3.3	13.2	500	412	371	165	206	186	82
TLJW227M006#0200	W	220	6.3	4.8	13.2	200	671	604	268	134	121	54
10 Volt @ 40C (5V @ 85C, 2V @ 125C)												
TLJJ475M010#KJ	J	4.7	10	0.5	0.5	10000	32	28	13	316	285	126
TLJR106M010#3000	R	10	10	1.4	1.0	3000	135	122	54	406	366	162
TLJR156M010#2000	R	15	10	2.0	1.5	2000	166	149	66	332	298	133
TLJR336M010#3500	R	33	10	1.3	3.3	3500	125	113	50	439	395	175
TLJP336M010#3500	P	33	10	1.3	3.3	3500	141	127	57	424	382	170
TLJS336M010#1500	S	33	10	2.6	3.3	1500	208	187	83	312	281	125
TLJP476M010#3200	P	47	10	1.4	4.7	3200	137	123	55	438	394	175
TLJA476M010#0600	A	47	10	4.8	4.7	600	354	318	141	212	191	85
TLJG476M010#1500	G	47	10	2.6	4.7	1500	216	194	86	324	292	130
TLJS476M010#1500	S	47	10	2.6	4.7	1500	208	187	83	312	281	125
TLJT476M010#0600	T	47	10	4.8	4.7	600	365	329	146	219	197	88
TLJH107M010#0900	H	100	10	3.7	10.0	900	298	268	119	268	241	107
TLJB157M010#0500	B	150	10	5.3	15.0	500	412	371	165	206	186	82
TLJW157M010#0200	W	150	10	7.7	15.0	200	671	604	268	134	121	54
16 Volt @ 40C (8V @ 85C, 3.2V @ 125C)												
TLJT226M016#1000	T	22	16	5.5	3.5	1000	283	255	113	283	255	113

insert R for 7" reel or S for 13" reel

All technical data relates to an ambient temperature of +25°C. Capacitance and DF are measured at 120Hz, 0.5 RMS with DC bias of 2.2 volts. DCL is measured at rated voltage after 5 minutes. TLJ series is MSL level 3 device.

ESR allowed to move up to 1.25 times catalog limit post mounting.

DCL allowed to move up to 2.00 times catalog limit post mounting.

NOTE: AVX reserves the right to supply a higher voltage rating in the same case size, to the same reliability standards.

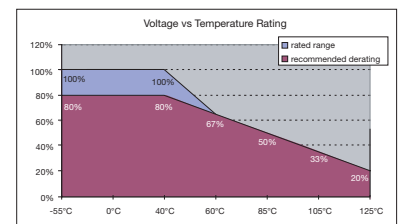

TAJ Series



Low Profile



Five additional case sizes are available in the TAJ range offering low profile solid tantalum chip capacitors. Designed for applications where maximum height of components above or below board are of prime consideration, this height of 1.2,

1.5 and 2.0mm equates to that of a standard integrated circuit package after mounting. The S&T footprints are identical to the A&B case size parts and the W&Y footprints to C&D case size parts.

CASE DIMENSIONS: millimeters (inches)

Code	EIA Code	L±0.20 (0.008)	W+0.20 (0.008) -0.10 (0.004)	H Max.	W ₁ ±0.20 (0.008)	A+0.30 (0.012) -0.20 (0.008)	S Min.
F*	6032-20	6.00 (0.236)	3.20 (0.126)	2.00 (0.079)	2.20 (0.087)	1.30 (0.051)	2.90 (0.114)
G	3216	3.20 (0.126)	1.60 (0.063)	1.50 (0.059)	1.20 (0.047)	0.80 (0.031)	1.10 (0.043)
H	3528-12	3.50 (0.138)	2.80 (0.110)	1.50 (0.059)	2.20 (0.087)	0.80 (0.031)	1.40 (0.055)
K*	3216-10	3.20 (0.126)	1.60 (0.063)	1.00 (0.039)	1.20 (0.047)	0.80 (0.031)	0.40 (0.016)
P	2012-15	2.05 (0.081)	1.35 (0.053)	1.50 (0.059)	1.0±0.1 (0.039±0.004)	0.50 (0.020)	0.85 (0.033)
R*	2012-12	2.05 (0.081)	1.30 (0.051)	1.20 (0.047)	1.0±0.1 (0.039±0.004)	0.50 (0.020)	0.70 (0.028)
S**	3216-12	3.20 (0.126)	1.60 (0.063)	1.20 (0.047)	1.20 (0.047)	0.80 (0.031)	1.10 (0.043)
T**	3528-12	3.50 (0.138)	2.80 (0.110)	1.20 (0.047)	2.20 (0.087)	0.80 (0.031)	2.00 (0.079)
W**	6032-15	6.00 (0.236)	3.20 (0.126)	1.50 (0.059)	2.20 (0.087)	1.30 (0.051)	2.90 (0.114)
Y**	7343-20	7.30 (0.287)	4.30 (0.169)	2.00 (0.079)	2.40 (0.094)	1.30 (0.051)	4.40 (0.173)
X**	7343-15	7.30 (0.287)	4.30 (0.169)	1.50 (0.059)	2.40 (0.094)	1.30 (0.051)	4.40 (0.173)

* 0805 Footprint Compatible
 ** Low Profile Versions of A & B & C & D Case, respectively
 W₁ dimension applies to the termination width for A dimensional area only.

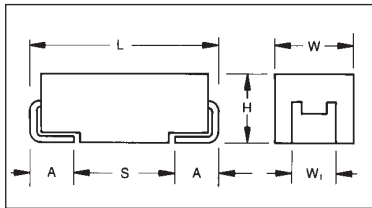

For part marking see page 164

HOW TO ORDER

TAJ

Type

Y

Case Size
See table above

107

Capacitance Code
pF code: 1st two digits represent significant figures
3rd digit represents multiplier (number of zeros to follow)

M

Tolerance
K=±10%
M=±20%

010

Rated DC Voltage
002=2.5Vdc
004=4Vdc
006=6.3Vdc
010=10Vdc
016=16Vdc
020=20Vdc
025=25Vdc
035=35Vdc
050=50Vdc

R

Packaging
R = 7" T/R
(Lead Free since production date 1/1/04)
S = 13" T/R
(Lead Free since production date 1/1/04)
A = Gold Plating
7" Reel
B = Gold Plating
13" Reel

**

Additional characters may be added for special requirements

TECHNICAL SPECIFICATIONS

Technical Data:	All technical data relate to an ambient temperature of +25°C									
Capacitance Range:	0.1 µF to 1000 µF									
Capacitance Tolerance:	±10%; ±20%									
Rated Voltage (V _R)	≧ +85°C:	2.5	4	6.3	10	16	20	25	35	50
Category Voltage (V _C)	≧ +125°C:	1.7	2.7	4	7	10	13	17	23	33
Surge Voltage (V _S)	≧ +85°C:	3.3	5.2	8	13	20	26	32	46	65
Surge Voltage (V _S)	≧ +125°C:	2.2	3.4	5	8	13	16	20	28	40
Temperature Range:	-55°C to +125°C									
Reliability:	1% per 1000 hours at 85°C, V _R with 0.1Ω/V series impedance, 60% confidence level									
	Meets requirements of AEC-Q200									



CAPACITANCE AND VOLTAGE RANGE, V_R (VOLTAGE CODE) RANGE (LETTER DENOTES CASE SIZE)

Capacitance		Rated voltage DC (V_R) to 85°C								
μF	Code	2.5V (e)	4V (G)	6.3V (J)	10V (A)	16V (C)	20V (D)	25V (E)	35V (V)	50V (T)
0.10	104						R/S		R/S	S
0.15	154						R/S	R	R/S	S
0.22	224						R/S	R	R/S	S
0.33	334						R/S	R	R/S	S/T
0.47	474						R/S	R/S	R/S/T	S/T
0.68	684					R/S	R/S/T	R/S	P/S/T	
1.0	105				R/S	R/S/T	R/S/T	P/R/S	P/S/T	W
1.5	155			R/S	R/S	R/S	P/R/S/T	P/S/T	T	W
2.2	225		R/S	R/S	R/S	R/S/T	P/S/T	T	T	
3.3	335		R/S	R/S	R/S/T	R/S/T	T	T/W	W	Y
4.7	475	R	R/S	R/S/T	R/S/T	K/P/S/T	T	T/W	W	Y
6.8	685	R	R/S/T	R/S/T	P/R/S/T	S/T	T	W	Y	Y
10	106	R/S	R/S/T	P/R/S/T	K/P ^(M) /R ^(M) /S/T	T/W	W	W	XY	
15	156	R	R/S/T	K/P/R/S/T	S/T/W	T ^(M) /W	W	Y	Y	
22	226	P/R	K/P/R/S/T	K/P ^(M) /S/T/W	T/W	W	W/Y	Y	Y	
33	336	K/P/S	K/P ^(M) /S/T/W	T/W	W	W/Y	XY	Y		
47	476	P ^(M) /S	T/W	T/W	W/Y	W/X/Y	XY			
68	686	T	T/W	W	W/Y	F/X/Y	Y			
100	107	T/W	T ^(M) /W	W/Y	W/X/Y	F ^(M) /Y				
150	157	T ^(M) /W	W/Y	W/X/Y	F/X ^(M) /Y	Y ^(M)				
220	227	W/Y	W/X/Y	F/X/Y	Y					
330	337	W ^(M) /Y	F/X/Y	Y						
470	477	F/Y	Y							
680	687	Y	Y ^(M)							
1000	108	Y ^(M)								

Released codes ^(M tolerance only)

Developmental Ratings - subject to change.

Note: Voltage ratings are minimum values. AVX reserves the right to supply higher ratings in the same case size, to the same reliability standards.

RATINGS & PART NUMBER REFERENCE

AVX Part No.	Case Size	Capacitance (μF)	Rated Voltage (V)	DCL (μA) Max.	DF % Max.	ESR Max. (Ω) @100kHz
TAJR475*002#	R	4.7	2.5	0.5	6	20
TAJR685*002#	R	6.8	2.5	0.5	6	20
TAJR106*002#	R	10	2.5	0.5	8	4.5
TAJS106*002#	S	10	2.5	0.5	6	8
TAJR156*002#	R	15	2.5	0.5	8	4.1
TAJP226*002#	P	22	2.5	0.5	8	3.5
TAJR226*002#	R	22	2.5	0.5	8	3.8
TAJK336*002#	K	33	2.5	0.8	8	1.7
TAJP336*002#	P	33	2.5	0.7	8	3.5
TAJS336*002#	S	33	2.5	0.7	8	1.5
TAJP476M002#	P	47	2.5	1.2	12	3.2
TAJS476*002#	S	47	2.5	1.2	8	1.6
TAJT686*002#	T	68	2.5	1.4	8	1.5
TAJT107*002#	T	100	2.5	2.5	15	1.3
TAJW107*002#	W	100	2.5	2.5	8	0.4
TAJT157M002#	T	150	2.5	3.8	18	1.2
TAJW157*002#	W	150	2.5	3.8	8	0.3
TAJW227*002#	W	220	2.5	5.5	8	0.3
TAJY227*002#	Y	220	2.5	5.5	8	0.3
TAJW337M002#	W	330	2.5	8.2	12	0.3
TAJY337*002#	Y	330	2.5	8.2	8	0.3
TAJF477*002#	F	470	2.5	11.8	12	0.3
TAJY477*002#	Y	470	2.5	11	12	0.2
TAJY687*002#	Y	680	2.5	17	12	0.2
TAJY108M002#	Y	108	2.5	25	30	0.2
TAJR225*004#	R	2.2	4	0.5	6	25
TAJS225*004#	S	2.2	4	0.5	6	25
TAJR335*004#	R	3.3	4	0.5	6	20
TAJS335*004#	S	3.3	4	0.5	6	18
TAJR475*004#	R	4.7	4	0.5	6	12
TAJS475*004#	S	4.7	4	0.5	6	10
TAJR685*004#	R	6.8	4	0.5	6	5.2
TAJS685*004#	S	6.8	4	0.5	6	8
TAJT685*004#	T	6.8	4	0.5	6	6
TAJR106*004#	R	10	4	0.5	6	7
TAJS106*004#	S	10	4	0.5	6	6
TAJT106*004#	T	10	4	0.6	6	5
TAJR156*004#	R	15	4	0.6	8	4
TAJS156*004#	S	15	4	0.6	8	4
TAJT156*004#	T	15	4	0.6	6	2
TAJK226*004#	K	22	4	0.9	8	1.8
TAJP226*004#	P	22	4	0.9	8	5
TAJR226*004#	R	22	4	0.9	8	3.8
TAJS226*004#	S	22	4	0.9	8	3.5
TAJT226*004#	T	22	4	0.9	6	1.9
TAJK336*004#	K	33	4	1.3	10	1.7
TAJP336M004#	P	33	4	1.3	8	3.4
TAJS336*004#	S	33	4	1.3	8	1.7
TAJT336*004#	T	33	4	1.3	6	1.7
TAJW336*004#	W	33	4	1.3	6	0.6
TAJT476*004#	T	47	4	1.9	10	2
TAJW476*004#	W	47	4	1.9	6	0.5
TAJT686*004#	T	68	4	2.7	15	1.5
TAJW686*004#	W	68	4	2.7	6	0.4
TAJT107M004#	T	100	4	4	14	1.4
TAJW107*004#	W	100	4	4	6	1.3
TAJW157*004#	W	150	4	6	6	1.3
TAJY157*004#	Y	150	4	6	6	0.4
TAJW227*004#	W	220	4	8.8	8	1.2
TAJX227*004#	X	220	4	8.8	8	0.9
TAJY227*004#	Y	220	4	8.8	8	0.3
TAJF337*004#	F	330	4	13.2	10	0.3
TAJX337*004#	X	330	4	13.2	8	0.1
TAJY477*004#	Y	470	4	18.8	14	0.9
TAJY687M004#	Y	680	4	27.2	25	0.2

AVX Part No.	Case Size	Capacitance (μF)	Rated Voltage (V)	DCL (μA) Max.	DF % Max.	ESR Max. (Ω) @100kHz
TAJR155*006#	R	1.5	6.3	0.5	6	2
TAJS155*006#	S	1.5	6.3	0.5	6	25
TAJR225*006#	R	2.2	6.3	0.5	6	20
TAJS225*006#	S	2.2	6.3	0.5	6	18
TAJR335*006#	R	3.3	6.3	0.5	6	12
TAJS335*006#	S	3.3	6.3	0.5	6	9
TAJR475*006#	R	4.7	6.3	0.5	6	7
TAJS475*006#	S	4.7	6.3	0.5	6	7.5
TAJT475*006#	T	4.7	6.3	0.5	6	6
TAJR685*006#	R	6.8	6.3	0.5	8	7
TAJS685*006#	S	6.8	6.3	0.5	6	2.6
TAJT685*006#	T	6.8	6.3	0.5	6	5
TAJR106*006#	R	10	6.3	0.6	8	6
TAJS106*006#	S	10	6.3	0.6	6	6
TAJT106*006#	T	10	6.3	0.6	6	4
TAJK156*006#	K	15	6.3	0.9	6	2
TAJP156*006#	P	15	6.3	0.9	8	3.5
TAJR156*006#	R	15	6.3	0.9	8	4.1
TAJS156*006#	S	15	6.3	0.9	8	4
TAJT156*006#	T	15	6.3	0.9	6	3.5
TAJK226*006#	K	22	6.3	1.3	10	1.8
TAJP226M006#	P	22	6.3	1.3	8	3.8
TAJS226*006#	S	22	6.3	1.3	10	1.8
TAJT226*006#	T	22	6.3	1.4	8	2.5
TAJW226*006#	W	22	6.3	1.3	6	0.6
TAJT336*006#	T	33	6.3	2.1	10	2.5
TAJW336*006#	W	33	6.3	2.1	6	1.8
TAJT476*006#	T	47	6.3	2.8	10	1.6
TAJW476*006#	W	47	6.3	3	6	1.5
TAJW686*006#	W	68	6.3	4.3	6	1.5
TAJY107*006#	Y	100	6.3	6.3	6	0.9
TAJW107*006#	W	100	6.3	6.3	6	0.9
TAJW157*006#	W	157	6.3	9	8	0.3
TAJX157*006#	X	150	6.3	9.5	6	0.9
TAJY157*006#	Y	150	6.3	9	6	0.4
TAJF227*006#	F	220	6.3	13.2	10	0.3
TAJX227*006#	X	220	6.3	13.2	8	0.3
TAJY227*006#	Y	220	6.3	13.9	10	0.9
TAJY337*006#	Y	330	6.3	20.8	8	0.9
TAJR105*010#	R	1	10	0.5	4	25
TAJS105*010#	S	1	10	0.5	4	25
TAJR106M010#	R	10	10	1	20	6
TAJR155*010#	R	1.5	10	0.5	6	20
TAJS155*010#	S	1.5	10	0.5	6	20
TAJR225*010#	R	2.2	10	0.5	6	15
TAJS225*010#	S	2.2	10	0.5	6	12
TAJR335*010#	R	3.3	10	0.5	6	8
TAJS335*010#	S	3.3	10	0.5	6	8
TAJT335*010#	T	3.3	10	0.5	6	6
TAJR475*010#	R	4.7	10	0.5	6	9
TAJS475*010#	S	4.7	10	0.5	6	5
TAJT475*010#	T	4.7	10	0.5	6	5
TAJP685*010#	P	6.8	10	0.7	6	4
TAJR685*010#	R	6.8	10	0.7	6	5.2
TAJS685*010#	S	6.8	10	0.7	6	4
TAJT685*010#	T	6.8	10	0.7	6	4
TAJK106*010#	K	10	10	1	6	2.2
TAJP106M010#	P	10	10	1	8	6
TAJS106*010#	S	10	10	1	8	4
TAJT106*010#	T	10	10	1	6	3
TAJS156*010#	S	15	10	1.5	6	2
TAJT156*010#	T	15	10	1.5	8	2.8
TAJW156*010#	W	15	10	1.5	6	0.7
TAJT226*010#	T	22	10	2.2	8	2.2
TAJW226*010#	W	22	10	2.2	6	0.6

All technical data relates to an ambient temperature of +25°C. Capacitance and DF are measured at 120Hz, 0.5V RMS with a maximum DC bias of 2.2 volts. DCL is measured at rated voltage after 5 minutes.

* Insert K for ±10% and M for ±20% Capacitance Tolerance # Standard Plating – Insert R for 7" reel and S for 13" reel # Gold Plating – Insert A for 7" reel and B for 13" reel

NOTE: AVX reserves the right to supply a higher voltage rating or tighter tolerance part in the same case size, to the same reliability standards.



RATINGS & PART NUMBER REFERENCE

AVX Part No.	Case Size	Capacitance (µF)	Rated Voltage (V)	DCL (µA) Max.	DF % Max.	ESR Max. (Ω) @100kHz
TAJW336*010#	W	33	10	3.3	6	1.6
TAJW476*010#	W	47	10	4.7	6	1.4
TAJY476*010#	Y	47	10	4.7	6	0.5
TAJY686*010#	Y	68	10	6.8	6	0.9
TAJW686*010#	W	68	10	6.8	6	1.3
TAJW107*010#	W	100	10	10	6	0.4
TAJX107*010#	X	100	10	10	8	0.9
TAJY107*010#	Y	100	10	10	6	0.9
TAJF157*010#	F	150	10	15	10	0.3
TAJX157M010#	X	150	10	15	6	0.3
TAJY157*010#	Y	150	10	15	6	1.2
TAJY227*010#	Y	220	10	22	10	0.5
TAJR684*016#	R	0.68	16	0.5	4	25
TAJS684*016#	S	0.68	16	0.5	4	25
TAJR105*016#	R	1	16	0.5	4	20
TAJS105*016#	S	1	16	0.5	4	15
TAJT105*016#	T	1	16	0.5	4	5
TAJR155*016#	R	1.5	16	0.5	6	10
TAJS155*016#	S	1.5	16	0.5	6	12
TAJR225*016#	R	2.2	16	0.5	6	6.5
TAJS225*016#	S	2.2	16	0.5	6	6
TAJT225*016#	T	2.2	16	0.5	6	6.5
TAJR335*016#	R	3.3	16	0.5	8	5
TAJS335*016#	S	3.3	16	0.5	6	5
TAJT335*016#	T	3.3	16	0.5	6	5
TAJK475*016#	K	4.7	16	0.8	6	3.1
TAJP475*016#	P	4.7	16	0.8	8	5
TAJS475*016#	S	4.7	16	0.8	8	4.5
TAJT475*016#	T	4.7	16	0.8	6	3.1
TAJS685*016#	S	6.8	16	1.1	8	2.4
TAJT685*016#	T	6.8	16	1.1	6	3.5
TAJT106*016#	T	10	16	1.6	8	2.2
TAJW106*016#	W	10	16	1.6	6	2
TAJT156M016#	T	15	16	2.4	6	2
TAJW156*016#	W	15	16	2.4	6	0.7
TAJW226*016#	W	22	16	3.5	6	1.6
TAJW336*016#	W	33	16	5.3	6	1.5
TAJY336*016#	Y	33	16	5.3	6	0.9
TAJW476*016#	W	47	16	7.5	6	0.4
TAJX476*016#	X	47	16	7.5	6	0.9
TAJY476*016#	Y	47	16	7.5	6	0.7
TAJF686*016#	F	68	16	10.9	10	0.4
TAJX686*016#	X	68	16	10.9	8	0.6
TAJY686*016#	Y	68	16	10.9	6	0.9
TAJF107M016#	F	100	16	16	10	0.4
TAJY107*016#	Y	10	16	16	8	0.9
TAJ157M016#	Y	150	16	24	15	0.3
TAJR104*020#	R	0.1	20	0.5	4	25
TAJS104*020#	S	0.1	20	0.5	4	25
TAJR154*020#	R	0.15	20	0.5	4	25
TAJS154*020#	S	0.15	20	0.5	4	25
TAJR224*020#	R	0.22	20	0.5	4	25
TAJS224*020#	S	0.22	20	0.5	4	25
TAJR334*020#	R	0.33	20	0.5	4	25
TAJS334*020#	S	0.33	20	0.5	4	25
TAJR474*020#	R	0.47	20	0.5	4	25
TAJS474*020#	S	0.47	20	0.5	4	25
TAJR684*020#	R	0.68	20	0.5	4	20
TAJS684*020#	S	0.68	20	0.5	4	25
TAJT684*020#	T	0.68	20	0.5	4	15
TAJR105*020#	R	1	20	0.5	4	20
TAJS105*020#	S	1	20	0.5	4	12
TAJT105*020#	T	1	20	0.5	4	9
TAJP155*020#	P	1.5	20	0.5	6	9.6

AVX Part No.	Case Size	Capacitance (µF)	Rated Voltage (V)	DCL (µA) Max.	DF % Max.	ESR Max. (Ω) @100kHz
TAJR155*020#	R	1.5	20	0.5	6	9.6
TAJS155*020#	S	1.5	20	0.5	6	5
TAJT155*020#	T	1.5	20	0.5	6	6.5
TAJP225*020#	P	2.2	20	0.5	6	8.3
TAJS225*020#	S	2.2	20	0.5	6	3
TAJT225*020#	T	2.2	20	0.5	6	6
TAJT335*020#	T	3.3	20	0.7	6	3
TAJT475*020#	T	4.7	20	0.9	6	3
TAJT685*020#	T	6.8	20	1.4	6	2.6
TAJW106*020#	W	10	20	2	6	1.9
TAJW156*020#	W	15	20	3	6	1.7
TAJY226*020#	Y	22	20	4.4	6	0.9
TAJW226*020#	W	22	20	4.4	6	1.6
TAJX336*020#	X	33	20	6.6	6	0.5
TAJY336*020#	Y	33	20	6.6	6	0.5
TAJX476*020#	X	47	20	9.4	6	0.4
TAJY476*020#	Y	47	20	9.4	6	0.4
TAJY686*020#	Y	68	20	13.6	6	0.4
TAJR154*025#	R	0.15	25	0.5	4	24
TAJR224*025#	R	0.22	25	0.5	4	21
TAJR334*025#	R	0.33	25	0.5	4	17
TAJR474*025#	R	0.47	25	0.5	4	15
TAJS474*025#	S	0.47	25	0.5	4	14
TAJR684*025#	R	0.68	25	0.5	4	13
TAJS684*025#	S	0.68	25	0.5	4	10
TAJP105*025#	P	1	25	0.5	4	11
TAJR105*025#	R	1	25	0.5	4	8
TAJS105*025#	S	1	25	0.5	4	8
TAJP105*025#	P	1.5	25	0.5	6	9.6
TAJS155*025#	S	1.5	25	0.5	6	5.4
TAJT155*025#	T	1.5	25	0.5	6	5
TAJT225*025#	T	2.2	25	0.6	6	4.5
TAJT335*025#	T	3.3	25	0.8	6	3.5
TAJW335*025#	W	3.3	25	0.8	6	1.6
TAJT475*025#	T	4.7	25	1.2	6	3.1
TAJW475*025#	W	4.7	25	1.2	6	1.2
TAJW685*025#	W	6.8	25	1.7	6	2
TAJW106*025#	W	10	25	2.5	6	1.8
TAJY156*025#	Y	15	25	3.8	6	1
TAJY226*025#	Y	22	25	5.5	6	0.9
TAJY336*025#	Y	33	25	8.3	6	0.5
TAJR104*035#	R	0.1	35	0.5	4	29
TAJS104*035#	S	0.1	35	0.5	4	24
TAJR154*035#	R	0.15	35	0.5	4	24
TAJS154*035#	S	0.15	35	0.5	4	21
TAJR224*035#	R	0.22	35	0.5	4	21
TAJS224*035#	S	0.22	35	0.5	4	18
TAJR334*035#	R	0.33	35	0.5	4	17
TAJS334*035#	S	0.33	35	0.5	4	15
TAJR474*035#	R	0.47	35	0.5	4	15
TAJS474*035#	S	0.47	35	0.5	4	12
TAJT474*035#	T	0.47	35	0.5	4	10
TAJP684*035#	P	0.68	35	0.5	4	13
TAJS684*035#	S	0.68	35	0.5	4	8
TAJT684*035#	T	0.68	35	0.5	4	8
TAJP105*035#	P	1	35	0.5	4	11
TAJS105*035#	S	1	35	0.5	4	7.5
TAJT105*035#	T	1	35	5	4	6.5
TAJT155*035#	T	1.5	35	0.5	6	5.2
TAJT225*035#	T	2.2	35	0.8	6	4.2
TAJW335*035#	W	3.3	35	1.2	6	1.6
TAJW475*035#	W	4.7	35	1.6	6	2.2
TAJY685*035#	Y	6.8	35	2.3	6	0.9
TAJX106*035#	X	10	35	3.5	6	0.7

All technical data relates to an ambient temperature of +25°C. Capacitance and DF are measured at 120Hz, 0.5V RMS with a maximum DC bias of 2.2 volts. DCL is measured at rated voltage after 5 minutes.

* Insert K for ±10% and M for ±20% Capacitance Tolerance # Standard Plating – Insert R for 7" reel and S for 13" reel # Gold Plating – Insert A for 7" reel and B for 13" reel

NOTE: AVX reserves the right to supply a higher voltage rating or tighter tolerance part in the same case size, to the same reliability standards.

TAJ Series



Low Profile

RATINGS & PART NUMBER REFERENCE

AVX Part No.	Case Size	Capacitance (μF)	Rated Voltage (V)	DCL (μA) Max.	DF % Max.	ESR Max. (Ω) @100kHz
TAJY106*035#	Y	10	35	3.5	6	1
TAJY156*035#	Y	15	35	5.3	6	0.6
TAJY226*035#	Y	22	35	7.7	6	0.5
TAJS104*050#	S	0.1	50	0.5	4	19
TAJS154*050#	S	0.15	50	0.5	4	16
TAJS224*050#	S	0.22	50	0.5	4	13
TAJS334*050#	S	0.33	50	0.5	4	11
TAJT334*050#	T	0.33	50	0.5	4	11
TAJS474*050#	S	0.47	50	0.5	4	9.5
TAJT474*050#	T	0.47	50	0.5	4	9.5
TAJW105*050#	W	1	50	0.5	6	4.4
TAJW155*050#	W	1.5	50	0.8	6	3.1
TAJY335*050#	Y	3.3	50	1.7	4	1.7
TAJY475*050#	Y	4.7	50	2.4	6	1.2
TAJY685*050#	Y	6.8	50	3.4	6	0.9



TPS Series



Low ESR



TPS surface mount products have inherently low ESR (equivalent series resistance) and are capable of higher ripple current handling, producing lower ripple voltages, less power and heat dissipation than standard product for the most efficient use of circuit power. TPS has been designed, manufactured, and preconditioned for

optimum performance in typical power supply applications. By combining the latest improvements in tantalum powder technology, improved manufacturing processes, and application specific preconditioning tests, AVX is able to provide a technologically superior alternative to the standard range.

CASE DIMENSIONS: millimeters (inches)

Code	EIA Code	Dimension Low Profile	L±0.20 (0.008)	W+0.20 (0.008) -0.10 (0.004)	H+0.20 (0.008) -0.10 (0.004)	W ₁ ±0.20 (0.008)	A+0.30 (0.012) -0.20 (0.008)	S Min.
A	3216-18	-	3.20 (0.126)	1.60 (0.063)	1.60 (0.063)	1.20 (0.047)	0.80 (0.031)	1.80 (0.071)
B	3528-21	-	3.50 (0.138)	2.80 (0.110)	1.90 (0.075)	2.20 (0.087)	0.80 (0.031)	1.40 (0.055)
C	6032-28	-	6.00 (0.236)	3.20 (0.126)	2.6 (0.102)	2.20 (0.087)	1.30 (0.051)	2.90 (0.114)
D	7343-31	-	7.30 (0.287)	4.30 (0.169)	2.90 (0.114)	2.40 (0.094)	1.30 (0.051)	4.40 (0.173)
E	7343-43	-	7.30 (0.287)	4.30 (0.169)	4.10 (0.162)	2.40 (0.094)	1.30 (0.051)	4.40 (0.173)
F**	6032-20	C Case (2.00)	6.00 (0.236)	3.20 (0.126)	2.00 (0.079)	2.20 (0.087)	1.30 (0.051)	2.90 (0.114)
P*	2012-15	-	2.05 (0.081)	1.35 (0.053)	1.50 (0.059) max.	1.0±0.1 (0.039±0.004)	0.50 (0.020)	0.85 (0.033)
R*	2012-12	R Case (1.20)	2.05 (0.081)	1.30 (0.051)	1.20 (0.047) max.	1.0±0.1 (0.039±0.004)	0.50 (0.020)	0.70 (0.028)
S**	3216-12	A Case (1.20)	3.20 (0.126)	1.60 (0.063)	1.20 (0.047) max.	1.20 (0.047)	0.80 (0.031)	1.10 (0.043)
T**	3528-12	B Case (1.20)	3.50 (0.138)	2.80 (0.110)	1.20 (0.047) max.	2.20 (0.087)	0.80 (0.031)	2.00 (0.079)
V	7361-38	-	7.30 (0.287)	6.10 (0.240)	3.45±0.30 (0.136±0.012)	3.10 (0.120)	1.40 (0.055)	1.80 (0.071)
W**	6032-15	C Case (1.50)	6.00 (0.236)	3.20 (0.126)	1.50 (0.059) max.	2.20 (0.087)	1.30 (0.051)	2.90 (0.114)
X**	7343-15	D Case (1.50)	7.30 (0.287)	4.30 (0.169)	1.50 (0.059) max.	2.40 (0.094)	1.30 (0.051)	4.40 (0.173)
Y**	7343-20	D Case (2.00)	7.30 (0.287)	4.30 (0.169)	2.00 (0.079) max.	2.40 (0.094)	1.30 (0.051)	4.40 (0.173)

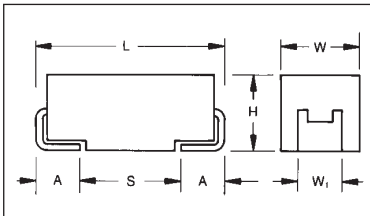

For part marking see page 164

W₁ dimension applies to the termination width for A dimensional area only.

* 0805 Footprint Compatible ** Low Profile Versions of A & B & C & D Case

HOW TO ORDER

TPS

Type

C

Case Size
See table above

107

Capacitor Code
pF code: 1st two digits represent significant figures, 3rd digit represents multiplier (number of zeros to follow)

M

Tolerance
K = ±10%
M = ±20%

010

Rated DC Voltage
002 = 2.5Vdc
004 = 4Vdc
006 = 6.3Vdc
010 = 10Vdc
016 = 16Vdc
020 = 20Vdc
025 = 25Vdc
035 = 35Vdc
050 = 50Vdc

R

Packaging
R = 7" T/R
(Lead Free since production date 1/1/04)
S = 13" T/R
(Lead Free since production date 1/1/04)
A = Gold Plating 7" Reel
B = Gold Plating 13" Reel
H = Tin Lead 7" Reel
(Contact Manufacturer)
K = Tin Lead 13" Reel
(Contact Manufacturer)

0100

Maximum ESR in Milliohms
See note below

NOTE: The EIA & CECC standards for low ESR Solid Tantalum Capacitors allow an ESR movement to 1.25 times catalog limit post mounting.

TECHNICAL SPECIFICATIONS

Technical Data:		All technical data relate to an ambient temperature of +25°C									
Capacitance Range:		0.15 µF to 1500 µF									
Capacitance Tolerance:		±10%; ±20%									
Rated Voltage (V _R)	≤ +85°C:	2.5	4	6.3	10	16	20	25	35	50	
Category Voltage (V _C)	≤ +125°C:	1.7	2.7	4	7	10	13	17	23	33	
Surge Voltage (V _S)	≤ +85°C:	3.3	5.2	8	13	20	26	32	46	65	
Surge Voltage (V _S)	≤ +125°C:	2.2	3.4	5	8	13	16	20	28	40	
Temperature Range:		-55°C to +125°C									
Environmental Classification:		55/125/56 (IEC 68-2)									
Reliability:		1% per 1000 hours at 85°C, V _R with 0.1Ω/V series impedance, 60% confidence level									
		Meets requirements of AEC-Q200									



TPS Series



Low ESR

CAPACITANCE AND RATED VOLTAGE, V_R (VOLTAGE CODE) RANGE (LETTER DENOTES CASE SIZE)

Capacitance		Rated Voltage DC (V_R) to 85°C								
μ F	Code	2.5V (e)	4V (G)	6.3V (J)	10V (A)	16V (C)	20V (D)	25V (E)	35V (V)	50V (T)
0.15	154									A(900)
0.22	224								A(6000)	A(7000)
0.33	334								A(6000)	
0.47	474							A(7000)	A(6000) B(4000)	
0.68	684							A(6000)	A(6000)	
1	105				R(9000)		A(3000), R(6000) S(6000), T(2000)	R(2500,4000)	A(3000) B(2000)	C(2500)
1.5	155							A(3000) B(1800)	B(2500)	C(1500,2000)
2.2	225			R(7000)	A(1800)	A(1800,3500) T(2000)	A(3000)	B(900,1200,2500)	A(1500), B(750, 1500,2000), C(1000)	D(1200)
3.3	335				T(1500)	A(3500)	A(2500) B(1300)	A(1000,1500) B(750,1500,2000)	B(1000) C(700)	D(800)
4.7	475			S(4000)	A(1400) R(3000,5000)	A(2000) B(800,1500)	A(1800) B(750,1000)	B(700,900,1500)	B(700,1500) C(600)	D(300,500,700)
6.8	685			A(1800)	A(1800) T(1800)	A(1500) B(600,1200)	A(1000) B(600,1000) C(700)	B(700) C(500,600,700)	C(350) D(150,400,500)	D(200, 300, 500,600)
10	106	R(3000)		A(1500) R(1000,1500,3000)	A(900,1800) P(2000) ^M T(1000,2000)	B(500,800), C(500) T(800,1000) W(500,600)	B(500,1000) C(500,700)	C(300,500)	D(125,300) E(200)	E(400,500)
15	156			A(700,1500)	A(1000) B(450,600)	B(500,800)	B(500) C(400,450)	C(220,300) D(100,300)	C(350,450) D(100,300) Y(250)	E(250)
22	226			A(500,900) B(375,600) S(900)	A(900) B(400,500,700) C(300), T(800)	B(400,600) C(150,250,300,375) W(500)	B(400,600) C(100,150,400) D(200,300)	C(275,400) D(100,200,300)	D(125,200,300,400) E(125,200,300) Y(200)	
33	336			A(600) B(250,350,450,600) T(800)	A(700) B(250,425,500,650) C(150,375,500) W(350)	B(350,500) C(100,150,225,300) D(200), W(140,175, 250,400,500) Y(300,400)	C(300) D(100,200)	D(100,200,300) E(100,175, 200,300) Y(200)	D(200,300) E(100,250,300) V(200)	
47	476	A(500)		A(800) B(250,350,500) C(300)	B(250,350,500,650) C(200,350) D(100) W(125,150,250)	C(110,350) D(80,100, 150,200) W(200) Y(250), X(180)	D(75,100,200) E(70,125,150, 200,250)	D(125,150,250) E(80,100,125)	E(200,250) V(150,200)	
68	686			B(250,350,500) C(150,200) W(110,125,250)	B(600) C(80,100,200,300) D(100,150), Y(100,200) W(100,150)	F(200) C(125,200) D(70,100,150) Y(150,200,250), X(150)	D(70,150, 200,300) E(125,150,200)	E(125,200) V(80,95,150,200)	V(150,200) ^M	
100	107	B(200)	B(200,250, 350,500) W(100)	B(250,400) C(75,150) Y(100) W(100)	B(400) ^M C(75,100,150,200) D(50,65,80,100,125, 150) E(125) W(150) X(85,150,200) Y(100,150,200)	F(150,200) ^M D(60,100,125,150) E(55,100,125,150) Y(100,150,200)	D(85,100,150) E(100,150,200) V(60,85,100,200)	V(100)		
150	157	B(150)	B(250) C(70,80)	C(50,90,150,200,250) D(50,125), Y(40)	F(200), D(50,85,100) E(100), X(100) ^M Y(100,150,200)	D(60,85,100,125,150) E(100), V(45,75) Y(200) ^M	V(80)			
220	227	B(150, 200,600) D(45)	D(40,50,100) Y(40)	F(200) C(70,100,125,250) D(50,100,125) E(100), Y(100,150)	D(40,50,100,150) E(50,60,70,100, 125,150) Y(150,200)	E(100,150) V(50,75, 100,150)				
330	337	Y(40)	F(200), C(100) D(35,45,100) X(100)	D(45,50,70,100) E(50,100,125,150) V(100), Y(150)	D(50,65,100,150) E(40,50,60,100) V(40,60,100)					
470	477	F(200) D(35) Y(100)	D(45,100) E(35,45,100)	D(45,60,100,200) E(45,50,60,100,200) V(40,55,100)	E(45,50,60,100,200) V(40,60,100)					
680	687	D(35,50) E(35,50) Y(100)	D(45,60,100) E(40,60,100)	E(45,60,100) V(35,40,50)						
1000	108	E(30,40) Y(100) ^M	E(60) V(25,35,40,50)	V(40,50) ^M						
1500	158	D(100) E(50) V(30,40)	E(50,75) V(50,75) ^M							

For C, D and E case ratings in TPS Series, ESR ratings are printed on capacitor side in the following format:
T x x x - where x x x is ESR limit in milliohms i.e. T100 represents max. ESR of 100 milliohms.

Released codes ^M (tolerance only)

ESR limits quoted in brackets (milliohms)

NOTE: The EIA & CECC standards for low ESR Solid Tantalum Capacitors allow an ESR movement to 1.25 times catalog limit post mounting.



TPS Series



Low ESR

RATINGS & PART NUMBER REFERENCE

AVX Part No.	Case Size	Capacitance (µF)	Rated Voltage (V)	DCL (µA) Max.	DF % Max.	ESR Max. (mΩ) @100kHz	100kHz Ripple Current Ratings (A)			100kHz Ripple Voltage Ratings (V)		
							25°C	85°C	125°C	25°C	85°C	125°C
TPSB107*002#0200	B	100	2.5	5	6	200	0.652	0.587	0.261	0.130	0.117	0.052
TPSB157*002#0150	B	150	2.5	3	10	150	0.753	0.677	0.301	0.113	0.102	0.045
TPSB227*002#0150	B	220	2.5	4.4	16	150	0.753	0.677	0.301	0.113	0.102	0.045
TPSB227*002#0200	B	220	2.5	4.4	16	200	0.652	0.587	0.261	0.130	0.117	0.052
TPSD687*002#0600	B	220	2.5	4.4	16	600	0.376	0.339	0.151	0.226	0.203	0.090
TPSD227*002#0045	D	220	2.5	4.4	8	45	1.826	1.643	0.730	0.082	0.074	0.033
TPSY337*002#0040	Y	330	2.5	8.2	8	40	1.768	1.591	0.707	0.071	0.064	0.028
TPSD477*002#0035	D	470	2.5	11.6	8	35	2.070	1.863	0.828	0.072	0.065	0.029
TPSF477*002#0200	F	470	2.5	11.8	12	200	0.707	0.636	0.283	0.141	0.127	0.057
TPSY477*002#0100	Y	470	2.5	11	12	100	1.118	1.006	0.447	0.112	0.101	0.045
TPSD687*002#0035	D	680	2.5	17	16	35	2.070	1.863	0.828	0.072	0.065	0.029
TPSD687*002#0050	D	680	2.5	17	16	50	1.732	1.559	0.693	0.087	0.078	0.035
TPSE687*002#0035	E	680	2.5	17	10	35	2.171	1.954	0.868	0.076	0.068	0.030
TPSE687*002#0050	E	680	2.5	17	10	50	1.817	1.635	0.727	0.091	0.082	0.036
TPSY687*002#0100	Y	680	2.5	17	12	100	1.118	1.006	0.447	0.112	0.101	0.045
TPSE108*002#0030	E	1000	2.5	20	14	30	2.345	2.111	0.938	0.070	0.063	0.028
TPSE108*002#0040	E	1000	2.5	20	14	40	2.031	1.828	0.812	0.081	0.073	0.032
TPSY108M002#0100	Y	1000	2.5	25	30	100	1.118	1.006	0.447	0.112	0.101	0.045
TPSE158*002#0050	E	1500	2.5	37.5	20	50	1.817	1.635	0.727	0.091	0.082	0.036
TPSD158*002#0100	D	1500	2.5	37.5	60	100	1.125	1.102	0.490	0.122	0.110	0.049
TPSV158*002#0030	V	1500	2.5	30	20	30	2.887	2.598	1.155	0.087	0.078	0.035
TPSV158*002#0040	V	1500	2.5	30	20	40	2.500	2.250	1.000	0.100	0.090	0.040
TPSR106*004#3000	R	10	4	0.5	6	3000	0.135	0.122	0.054	0.406	0.366	0.162
TPSA476*004#0500	A	47	4	1.9	8	500	0.387	0.349	0.155	0.194	0.174	0.077
TPSB107*004#0200	B	100	4	4	8	200	0.652	0.587	0.261	0.130	0.117	0.052
TPSB107*004#0250	B	100	4	4	8	250	0.583	0.525	0.233	0.146	0.131	0.058
TPSB107*004#0350	B	100	4	4	8	350	0.493	0.444	0.197	0.172	0.155	0.069
TPSB107*004#0500	B	100	4	4	8	500	0.412	0.371	0.165	0.206	0.186	0.082
TPSW107*004#0100	W	100	4	4	6	100	0.949	0.854	0.379	0.095	0.085	0.038
TPSB157*004#0250	B	150	4	6	10	250	0.583	0.525	0.233	0.146	0.131	0.058
TPSC157*004#0070	C	150	4	6	6	70	1.254	1.128	0.501	0.088	0.079	0.035
TPSC157*004#0080	C	150	4	6	6	80	1.173	1.055	0.469	0.094	0.084	0.038
TPSD227*004#0040	D	220	4	8.8	8	40	1.936	1.743	0.775	0.077	0.070	0.031
TPSD227*004#0050	D	220	4	8.8	8	50	1.732	1.559	0.693	0.087	0.078	0.035
TPSD227*004#0100	D	220	4	8.8	8	100	1.225	1.102	0.490	0.122	0.110	0.049
TPSY227*004#0040	Y	220	4	8.8	8	40	1.768	1.591	0.707	0.071	0.064	0.028
TPSC337*004#0100	C	330	4	13.2	8	100	1.049	0.944	0.420	0.105	0.094	0.042
TPSD337*004#0035	D	330	4	13.2	8	35	2.070	1.863	0.828	0.072	0.065	0.029
TPSD337*004#0045	D	330	4	13.2	8	45	1.826	1.643	0.730	0.082	0.074	0.033
TPSD337*004#0100	D	330	4	13.2	8	100	1.225	1.102	0.490	0.122	0.110	0.049
TPSF337*004#0200	F	330	4	13.2	10	200	0.707	0.636	0.283	0.141	0.127	0.057
TPSX337*004#0100	X	330	4	13.2	8	100	1.000	0.900	0.400	0.100	0.090	0.040
TPSD477*004#0045	D	470	4	18.8	12	45	1.826	1.643	0.730	0.082	0.074	0.033
TPSD477*004#0100	D	470	4	18.8	12	100	1.225	1.102	0.490	0.122	0.110	0.049
TPSE477*004#0035	E	470	4	18.8	12	35	2.171	1.954	0.868	0.076	0.068	0.030
TPSE477*004#0045	E	470	4	18.8	12	45	1.915	1.723	0.766	0.086	0.078	0.034
TPSE477*004#0100	E	470	4	18.8	12	100	1.285	1.156	0.514	0.128	0.116	0.051
TPSD687*004#0045	D	680	4	27.2	14	45	1.915	1.643	0.730	0.082	0.074	0.033
TPSD687*004#0060	D	680	4	27.2	14	60	1.581	1.423	0.632	0.095	0.085	0.038
TPSD687*004#0100	D	680	4	27.2	14	100	1.225	1.102	0.490	0.122	0.110	0.049
TPSE687*004#0040	E	680	4	27.2	10	40	2.031	1.828	0.812	0.081	0.073	0.032
TPSE687*004#0060	E	680	4	27.2	10	60	1.658	1.492	0.663	0.099	0.090	0.040
TPSE687*004#0100	E	680	4	27.2	10	100	1.285	1.156	0.514	0.128	0.116	0.051
TPSE108*004#0060	E	1000	4	40	14	60	1.658	1.492	0.663	0.099	0.090	0.040
TPSV108*004#0025	V	1000	4	40	16	25	3.162	2.846	1.265	0.079	0.071	0.032
TPSV108*004#0035	V	1000	4	40	16	35	2.673	2.405	1.069	0.094	0.084	0.037
TPSV108*004#0040	V	1000	4	40	16	40	2.500	2.250	1.000	0.100	0.090	0.040
TPSV108*004#0050	V	1000	4	40	16	50	2.236	2.012	0.894	0.112	0.101	0.045
TPSE158*004#0050	E	1500	4	60	30	50	1.817	1.635	0.727	0.091	0.082	0.036
TPSE158*004#0075	E	1500	4	60	30	75	1.483	1.335	0.593	0.111	0.100	0.044
TPSV158M004#0050	V	1500	4	60	30	50	2.236	2.012	0.894	0.112	0.101	0.045
TPSV158M004#0075	V	1500	4	60	30	75	1.826	1.643	0.730	0.137	0.123	0.055
TPSR225*006#7000	R	2.2	6.3	0.5	6	7000	0.089	0.080	0.035	0.620	0.558	0.248
TPSS475*006#4000	S	4.7	6.3	0.5	6	4000	0.127	0.115	0.051	0.510	0.459	0.204
TPSA685*006#1800	A	6.8	6.3	0.5	6	1800	0.204	0.184	0.082	0.367	0.331	0.147
TPSA106*006#1500	A	10	6.3	0.6	6	1500	0.224	0.201	0.089	0.335	0.302	0.134
TPSR106*006#1000	R	10	6.3	0.6	8	1000	0.235	0.211	0.094	0.235	0.211	0.094
TPSR106*006#1500	R	10	6.3	0.6	8	1500	0.191	0.172	0.077	0.287	0.259	0.115
TPSR106*006#3000	R	10	6.3	0.6	8	3000	0.135	0.122	0.054	0.406	0.366	0.162
TPSA156*006#0700	A	15	6.3	0.9	6	700	0.327	0.295	0.131	0.229	0.206	0.092

All technical data relates to an ambient temperature of +25°C.
 Capacitance and DF are measured at 120Hz, 0.5V RMS with a maximum DC bias of 2.2 volts. DCL is measured at rated voltage after 5 minutes.
 * Insert K for ±10% and M for ±20% Capacitance Tolerance

Standard Plating – Insert R for 7" reel and S for 13" reel
 # **Gold Plating** – Insert A for 7" reel and B for 13" reel
 # **Tin Lead Plating** – Insert H for 7" reel (contact manufacturer)
 # **Tin Lead Plating** – Insert K for 13" reel (contact manufacturer)



TPS Series



Low ESR

RATINGS & PART NUMBER REFERENCE

AVX Part No.	Case Size	Capacitance (µF)	Rated Voltage (V)	DCL (µA) Max.	DF % Max.	ESR Max. (mΩ) @100kHz	100kHz Ripple Current Ratings (A)			100kHz Ripple Voltage Ratings (V)		
							25°C	85°C	125°C	25°C	85°C	125°C
TPSA156*006#1500	A	15	6.3	0.9	6	1500	0.224	0.201	0.089	0.335	0.302	0.134
TPSA226*006#0500	A	22	6.3	1.4	6	500	0.387	0.349	0.155	0.194	0.174	0.077
TPSA226*006#0900	A	22	6.3	1.4	6	900	0.289	0.260	0.115	0.260	0.234	0.104
TPSB226*006#0375	B	22	6.3	1.4	6	375	0.476	0.428	0.190	0.179	0.161	0.071
TPSB226*006#0600	B	22	6.3	1.4	6	600	0.376	0.339	0.151	0.226	0.203	0.090
TPSS226*006#0900	S	22	6.3	1.4	8	900	0.269	0.242	0.107	0.242	0.218	0.097
TPSA336*006#0600	A	33	6.3	2.1	8	600	0.354	0.318	0.141	0.212	0.191	0.085
TPSB336*006#0250	B	33	6.3	2.1	6	250	0.583	0.525	0.233	0.146	0.131	0.058
TPSB336*006#0350	B	33	6.3	2.1	6	350	0.493	0.444	0.197	0.172	0.155	0.069
TPSB336*006#0450	B	33	6.3	2.1	6	450	0.435	0.391	0.174	0.196	0.176	0.078
TPSB336*006#0600	B	33	6.3	2.1	6	600	0.376	0.339	0.151	0.226	0.203	0.090
TPST336*006#0800	T	33	6.3	2.1	10	800	0.316	0.285	0.126	0.253	0.228	0.101
TPSA476*006#0800	A	47	6.3	2.8	10	800	0.306	0.276	0.122	0.245	0.220	0.098
TPSB476*006#0250	B	47	6.3	3	6	250	0.583	0.525	0.233	0.146	0.131	0.058
TPSB476*006#0350	B	47	6.3	3	6	350	0.493	0.444	0.197	0.172	0.155	0.069
TPSB476*006#0500	B	47	6.3	3	6	500	0.412	0.371	0.165	0.206	0.186	0.082
TPSC476*006#0300	C	47	6.3	3	6	300	0.606	0.545	0.242	0.182	0.163	0.073
TPSB686*006#0250	B	68	6.3	4.3	8	250	0.583	0.525	0.233	0.146	0.131	0.058
TPSB686*006#0350	B	68	6.3	4.3	8	350	0.493	0.444	0.197	0.172	0.155	0.069
TPSB686*006#0500	B	68	6.3	4.3	8	500	0.412	0.371	0.165	0.206	0.186	0.082
TPSC686*006#0150	C	68	6.3	4.3	6	150	0.856	0.771	0.343	0.128	0.116	0.051
TPSC686*006#0200	C	68	6.3	4.3	6	200	0.742	0.667	0.297	0.148	0.133	0.059
TPSW686*006#0110	W	68	6.3	4.3	6	110	0.905	0.814	0.362	0.099	0.090	0.040
TPSW686*006#0125	W	68	6.3	4.3	6	125	0.849	0.764	0.339	0.106	0.095	0.042
TPSW686*006#0250	W	68	6.3	4.3	6	250	0.600	0.540	0.240	0.150	0.135	0.060
TPSB107*006#0250	B	100	6.3	6.3	10	250	0.583	0.525	0.233	0.146	0.131	0.058
TPSB107*006#0400	B	100	6.3	6.3	10	400	0.461	0.415	0.184	0.184	0.166	0.074
TPSC107*006#0075	C	100	6.3	6.3	6	75	1.211	1.090	0.484	0.091	0.082	0.036
TPSC107*006#0150	C	100	6.3	6.3	6	150	0.856	0.771	0.343	0.128	0.116	0.051
TPSY107*006#0100	Y	100	6.3	6.3	6	100	1.118	1.006	0.447	0.112	0.101	0.045
TPSW107*006#0100	W	100	6.3	6.3	6	100	0.949	0.854	0.379	0.095	0.085	0.038
TPSC157*006#0050	C	150	6.3	9.5	6	50	1.483	1.335	0.593	0.074	0.067	0.030
TPSC157*006#0090	C	150	6.3	9.5	6	90	1.106	0.995	0.442	0.099	0.090	0.040
TPSC157*006#0150	C	150	6.3	9.5	6	150	0.856	0.771	0.343	0.128	0.116	0.051
TPSC157*006#0200	C	150	6.3	9.5	6	200	0.742	0.667	0.297	0.148	0.133	0.059
TPSC157*006#0250	C	150	6.3	9.5	6	250	0.663	0.597	0.265	0.166	0.149	0.066
TPSD157*006#0050	D	150	6.3	9.5	6	50	1.732	1.559	0.693	0.087	0.078	0.035
TPSD157*006#0125	D	150	6.3	9.5	6	125	1.095	0.986	0.438	0.137	0.123	0.055
TPSY157*006#0040	Y	150	6.3	9.5	6	40	1.768	1.591	0.707	0.071	0.064	0.028
TPSC227*006#0070	C	220	6.3	13.9	8	70	1.254	1.128	0.501	0.088	0.079	0.035
TPSC227*006#0100	C	220	6.3	13.9	8	100	1.049	0.944	0.420	0.105	0.094	0.042
TPSC227*006#0125	C	220	6.3	13.9	8	125	0.938	0.844	0.375	0.117	0.106	0.047
TPSC227*006#0250	C	220	6.3	13.9	8	250	0.663	0.597	0.265	0.166	0.149	0.066
TPSD227*006#0050	D	220	6.3	13.9	8	50	1.732	1.559	0.693	0.087	0.078	0.035
TPSD227*006#0100	D	220	6.3	13.2	8	100	1.225	1.102	0.490	0.122	0.110	0.049
TPSD227*006#0125	D	220	6.3	13.9	8	125	1.095	0.986	0.438	0.137	0.123	0.055
TPSE227*006#0100	E	220	6.3	13.2	8	100	1.285	1.156	0.514	0.128	0.116	0.051
TPSF227*006#0200	F	220	6.3	13.2	10	200	0.707	0.636	0.283	0.141	0.127	0.057
TPSY227*006#0100	Y	220	6.3	13.9	10	100	1.118	1.006	0.447	0.112	0.101	0.045
TPSY227*006#0150	Y	220	6.3	13.9	10	150	0.913	0.822	0.365	0.137	0.123	0.055
TPSD337*006#0045	D	330	6.3	20.8	8	45	1.826	1.643	0.730	0.082	0.074	0.033
TPSD337*006#0050	D	330	6.3	20.8	8	50	1.732	1.559	0.693	0.087	0.078	0.035
TPSD337*006#0070	D	330	6.3	20.8	8	70	1.464	1.317	0.586	0.102	0.092	0.041
TPSD337*006#0100	D	330	6.3	20.8	8	100	1.225	1.102	0.490	0.122	0.110	0.049
TPSE337*006#0050	E	330	6.3	20.8	8	50	1.817	1.635	0.727	0.091	0.082	0.036
TPSE337*006#0100	E	330	6.3	20.8	8	100	1.285	1.156	0.514	0.128	0.116	0.051
TPSE337*006#0125	E	330	6.3	20.8	8	125	1.149	1.034	0.460	0.144	0.129	0.057
TPSE337*006#0150	E	330	6.3	20.8	8	150	1.049	0.944	0.420	0.157	0.142	0.063
TPSV337*006#0100	V	330	6.3	20.8	8	100	1.581	1.423	0.632	0.158	0.142	0.063
TPSY337*006#0150	Y	330	6.3	20.8	12	150	0.913	0.822	0.365	0.137	0.123	0.055
TPSD477*006#0045	D	470	6.3	29.6	12	45	1.826	1.643	0.730	0.082	0.074	0.033
TPSD477*006#0060	D	470	6.3	29.6	12	60	1.581	1.423	0.632	0.095	0.085	0.038
TPSD477*006#0100	D	470	6.3	29.6	12	100	1.225	1.102	0.490	0.122	0.110	0.049
TPSD477*006#0200	D	470	6.3	29.6	12	200	0.866	0.779	0.346	0.173	0.156	0.069
TPSE477*006#0045	E	470	6.3	29.6	10	45	1.915	1.723	0.766	0.086	0.078	0.034
TPSE477*006#0050	E	470	6.3	29.6	10	50	1.817	1.635	0.727	0.091	0.082	0.036
TPSE477*006#0060	E	470	6.3	29.6	10	60	1.658	1.492	0.663	0.099	0.090	0.040
TPSE477*006#0100	E	470	6.3	29.6	10	100	1.285	1.156	0.514	0.128	0.116	0.051

All technical data relates to an ambient temperature of +25°C.
 Capacitance and DF are measured at 120Hz, 0.5V RMS with a maximum DC bias of 2.2 volts. DCL is measured at rated voltage after 5 minutes.
 * Insert K for ±10% and M for ±20% Capacitance Tolerance

Standard Plating – Insert R for 7" reel and S for 13" reel
 # **Gold Plating** – Insert A for 7" reel and B for 13" reel
 # **Tin Lead Plating** – Insert H for 7" reel (contact manufacturer)
 # **Tin Lead Plating** – Insert K for 13" reel (contact manufacturer)



TPS Series



Low ESR

RATINGS & PART NUMBER REFERENCE

AVX Part No.	Case Size	Capacitance (µF)	Rated Voltage (V)	DCL (µA) Max.	DF % Max.	ESR Max. (mΩ) @100kHz	100kHz Ripple Current Ratings (A)			100kHz Ripple Voltage Ratings (V)		
							25°C	85°C	125°C	25°C	85°C	125°C
TPSE477*006#0200	E	470	6.3	29.6	10	200	0.908	0.817	0.363	0.182	0.163	0.073
TPSV477*006#0040	V	470	6.3	29.6	10	40	2.500	2.250	1.000	0.100	0.090	0.040
TPSV477*006#0055	V	470	6.3	29.6	10	55	2.132	1.919	0.853	0.117	0.106	0.047
TPSV477*006#0100	V	470	6.3	29.6	10	100	1.581	1.423	0.632	0.158	0.142	0.063
TPSE687*006#0045	E	680	6.3	42.8	10	45	1.915	1.723	0.766	0.086	0.078	0.034
TPSE687*006#0060	E	680	6.3	42.8	10	60	1.658	1.492	0.663	0.099	0.090	0.040
TPSE687*006#0100	E	680	6.3	42.8	10	100	1.285	1.156	0.514	0.128	0.116	0.051
TPSV687*006#0035	V	680	6.3	42.8	14	35	2.673	2.405	1.069	0.094	0.084	0.037
TPSV687*006#0040	V	680	6.3	42.8	10	40	2.500	2.250	1.000	0.100	0.090	0.040
TPSV687*006#0050	V	680	6.3	42.8	10	50	2.236	2.012	0.894	0.112	0.101	0.045
TPSV108M006#0040	V	1000	6.3	60	16	40	2.500	2.250	1.000	0.100	0.090	0.040
TPSV108M006#0050	V	1000	6.3	60	16	50	2.236	2.012	0.894	0.112	0.101	0.045
TPSR105*010#9000	R	1	10	0.5	4	9000	0.078	0.070	0.031	0.704	0.633	0.281
TPSA225*010#1800	A	2.2	10	0.5	6	1800	0.204	0.184	0.082	0.367	0.331	0.147
TPST335*010#1500	T	3.3	10	0.5	6	1500	0.231	0.208	0.092	0.346	0.312	0.139
TPSA475*010#1400	A	4.7	10	0.5	6	1400	0.231	0.208	0.093	0.324	0.292	0.130
TPSR475*010#3000	R	4.7	10	0.5	6	3000	0.135	0.122	0.054	0.406	0.366	0.162
TPSR475*010#5000	R	4.7	10	0.5	6	5000	0.105	0.094	0.042	0.524	0.472	0.210
TPSA685*010#1800	A	6.8	10	0.7	6	1800	0.204	0.184	0.082	0.367	0.331	0.147
TPST685*010#1800	T	6.8	10	0.7	6	1800	0.211	0.190	0.084	0.379	0.342	0.152
TPSA106*010#0900	A	10	10	1	6	900	0.289	0.260	0.115	0.260	0.234	0.104
TPSA106*010#1800	A	10	10	1	6	1800	0.204	0.184	0.082	0.367	0.331	0.147
TPSP106M010#2000	P	10	10	1	8	2000	0.173	0.156	0.069	0.346	0.312	0.139
TPST106*010#1000	T	10	10	1	6	1000	0.283	0.255	0.113	0.283	0.255	0.113
TPST106*010#2000	T	10	10	1	6	2000	0.200	0.180	0.080	0.400	0.360	0.160
TPSA156*010#1000	A	15	10	1.5	6	1000	0.274	0.246	0.110	0.274	0.246	0.110
TPSB156*010#0450	B	15	10	1.5	6	450	0.435	0.391	0.174	0.196	0.176	0.078
TPSB156*010#0600	B	15	10	1.5	6	600	0.376	0.339	0.151	0.226	0.203	0.090
TPSB226*010#0400	B	22	10	2.2	6	400	0.461	0.415	0.184	0.184	0.166	0.074
TPSB226*010#0500	B	22	10	2.2	6	500	0.412	0.371	0.165	0.206	0.186	0.082
TPSB226*010#0700	B	22	10	2.2	6	700	0.348	0.314	0.139	0.244	0.220	0.098
TPSC226*010#0300	C	22	10	2.2	6	300	0.606	0.545	0.242	0.182	0.163	0.073
TPST226*010#0800	T	22	10	2.2	8	800	0.316	0.285	0.126	0.253	0.228	0.101
TPSA336*010#0700	A	33	10	3.3	8	700	0.327	0.295	0.131	0.229	0.206	0.092
TPSB336*010#0250	B	33	10	3.3	6	250	0.583	0.525	0.233	0.146	0.131	0.058
TPSB336*010#0425	B	33	10	3.3	6	425	0.447	0.402	0.179	0.190	0.171	0.076
TPSB336*010#0500	B	33	10	3.3	6	500	0.412	0.371	0.165	0.206	0.186	0.082
TPSB336*010#0650	B	33	10	3.3	6	650	0.362	0.325	0.145	0.235	0.212	0.094
TPSC336*010#0150	C	33	10	3.3	6	150	0.856	0.771	0.343	0.128	0.116	0.051
TPSC336*010#0375	C	33	10	3.3	6	375	0.542	0.487	0.217	0.203	0.183	0.081
TPSC336*010#0500	C	33	10	3.3	6	500	0.469	0.422	0.188	0.235	0.211	0.094
TPSW336*010#0350	W	33	10	3.3	6	350	0.507	0.456	0.203	0.177	0.160	0.071
TPSB476*010#0250	B	47	10	4.7	8	250	0.583	0.525	0.233	0.146	0.131	0.058
TPSB476*010#0350	B	47	10	4.7	8	350	0.493	0.444	0.197	0.172	0.155	0.069
TPSB476*010#0500	B	47	10	4.7	8	500	0.412	0.371	0.165	0.206	0.186	0.082
TPSB476*010#0650	B	47	10	4.7	8	650	0.362	0.325	0.145	0.235	0.212	0.094
TPSC476*010#0200	C	47	10	4.7	6	200	0.742	0.667	0.297	0.148	0.133	0.059
TPSC476*010#0350	C	47	10	4.7	6	350	0.561	0.505	0.224	0.196	0.177	0.078
TPSD476*010#0100	D	47	10	4.7	6	100	1.225	1.102	0.490	0.122	0.110	0.049
TPSW476*010#0125	W	47	10	4.7	6	125	0.849	0.764	0.339	0.106	0.095	0.042
TPSW476*010#0150	W	47	10	4.7	6	150	0.775	0.697	0.310	0.116	0.105	0.046
TPSW476*010#0250	W	47	10	4.7	6	250	0.600	0.540	0.240	0.150	0.135	0.060
TPSB686*010#0600	B	68	10	6.8	8	600	0.376	0.339	0.151	0.226	0.203	0.090
TPSC686*010#0080	C	68	10	6.8	6	80	1.173	1.055	0.469	0.094	0.084	0.038
TPSC686*010#0100	C	68	10	6.8	6	100	1.049	0.944	0.420	0.105	0.094	0.042
TPSC686*010#0200	C	68	10	6.8	6	200	0.742	0.667	0.297	0.148	0.133	0.059
TPSC686*010#0300	C	68	10	6.8	6	300	0.606	0.545	0.242	0.182	0.163	0.073
TPSD686*010#0100	D	68	10	6.8	6	100	1.225	1.102	0.490	0.122	0.110	0.049
TPSD686*010#0150	D	68	10	6.8	6	150	1.000	0.900	0.400	0.150	0.135	0.060
TPSY686*010#0100	Y	68	10	6.8	6	100	1.118	1.006	0.447	0.112	0.101	0.045
TPSY686*010#0200	Y	68	10	6.8	6	200	0.791	0.712	0.316	0.158	0.142	0.063
TPSW686*010#0100	W	68	10	6.8	6	100	0.949	0.854	0.379	0.095	0.085	0.038
TPSW686*010#0150	W	68	10	6.8	6	150	0.775	0.697	0.310	0.116	0.105	0.046
TPSB107M010#0400	B	100	10	10	8	400	0.461	0.415	0.184	0.184	0.166	0.074
TPSC107*010#0075	C	100	10	10	8	75	1.211	1.090	0.484	0.091	0.082	0.036
TPSC107*010#0100	C	100	10	10	8	100	1.049	0.944	0.420	0.105	0.094	0.042
TPSC107*010#0150	C	100	10	10	8	150	0.856	0.771	0.343	0.128	0.116	0.051
TPSC107*010#0200	C	100	10	10	8	200	0.742	0.667	0.297	0.148	0.133	0.059

All technical data relates to an ambient temperature of +25°C.
 Capacitance and DF are measured at 120Hz, 0.5V RMS with a maximum DC bias of 2.2 volts. DCL is measured at rated voltage after 5 minutes.
 * Insert K for ±10% and M for ±20% Capacitance Tolerance

Standard Plating – Insert R for 7" reel and S for 13" reel
 # **Gold Plating** – Insert A for 7" reel and B for 13" reel
 # **Tin Lead Plating** – Insert H for 7" reel (contact manufacturer)
 # **Tin Lead Plating** – Insert K for 13" reel (contact manufacturer)



TPS Series



Low ESR

RATINGS & PART NUMBER REFERENCE

AVX Part No.	Case Size	Capacitance (μF)	Rated Voltage (V)	DCL (μA) Max.	DF % Max.	ESR Max. (mΩ) @100kHz	100kHz Ripple Current Ratings (A)			100kHz Ripple Voltage Ratings (V)		
							25°C	85°C	125°C	25°C	85°C	125°C
TPSD107*010#0050	D	100	10	10	6	50	1.732	1.559	0.693	0.087	0.078	0.035
TPSD107*010#0065	D	100	10	10	6	65	1.519	1.367	0.608	0.099	0.089	0.039
TPSD107*010#0080	D	100	10	10	6	80	1.369	1.232	0.548	0.110	0.099	0.044
TPSD107*010#0100	D	100	10	10	6	100	1.225	1.102	0.490	0.122	0.110	0.049
TPSD107*010#0125	D	100	10	10	6	125	1.095	0.986	0.438	0.137	0.123	0.055
TPSD107*010#0150	D	100	10	10	6	150	1.000	0.900	0.400	0.150	0.135	0.060
TPSE107*010#0125	E	100	10	10	6	125	1.149	1.034	0.460	0.144	0.129	0.057
TPSY107*010#0100	Y	100	10	10	6	100	1.118	1.006	0.447	0.112	0.101	0.045
TPSY107*010#0150	Y	100	10	10	6	150	0.913	0.822	0.365	0.137	0.123	0.055
TPSY107*010#0200	Y	100	10	10	6	200	0.791	0.712	0.316	0.158	0.142	0.063
TPSX107*010#0085	X	100	10	10	8	85	1.085	0.976	0.434	0.092	0.083	0.037
TPSX107*010#0150	X	100	10	10	8	150	0.816	0.735	0.327	0.122	0.110	0.049
TPSX107*010#0200	X	100	10	10	8	200	0.707	0.636	0.283	0.141	0.127	0.057
TPSW107*010#0150	W	100	10	10	6	150	0.775	0.697	0.310	0.116	0.105	0.046
TPSD157*010#0050	D	150	10	15	6	50	1.732	1.559	0.693	0.087	0.078	0.035
TPSD157*010#0085	D	150	10	15	8	85	1.328	1.196	0.531	0.113	0.102	0.045
TPSD157*010#0100	D	150	10	15	8	100	1.225	1.102	0.490	0.122	0.110	0.049
TPSE157*010#0100	E	150	10	15	8	100	1.285	1.156	0.514	0.128	0.116	0.051
TPSF157*010#0200	F	150	10	15	10	200	0.707	0.636	0.283	0.141	0.127	0.057
TPSX157MO10#0100	X	150	10	15	6	100	1.000	0.900	0.400	0.100	0.090	0.040
TPSY157*010#0100	Y	150	10	15	6	100	1.118	1.006	0.447	0.112	0.101	0.045
TPSY157*010#0150	Y	150	10	15	6	150	0.913	0.822	0.365	0.137	0.123	0.055
TPSY157*010#0200	Y	150	10	15	6	200	0.791	0.712	0.316	0.158	0.142	0.063
TPSD227*010#0050	D	220	10	22	8	50	1.732	1.559	0.693	0.087	0.078	0.035
TPSD227*010#0100	D	220	10	22	8	100	1.225	1.102	0.490	0.122	0.110	0.049
TPSD227*010#0150	D	220	10	22	8	150	1.000	0.900	0.400	0.150	0.135	0.060
TPSE227*010#0050	E	220	10	22	8	50	1.817	1.635	0.727	0.091	0.082	0.036
TPSE227*010#0060	E	220	10	22	8	60	1.658	1.492	0.663	0.099	0.090	0.040
TPSE227*010#0070	E	220	10	22	8	70	1.535	1.382	0.614	0.107	0.097	0.043
TPSE227*010#0100	E	220	10	22	8	100	1.285	1.156	0.514	0.128	0.116	0.051
TPSE227*010#0125	E	220	10	22	8	125	1.149	1.034	0.460	0.144	0.129	0.057
TPSE227*010#0150	E	220	10	22	8	150	1.049	0.944	0.420	0.157	0.142	0.063
TPSY227*010#0150	Y	220	10	22	10	150	0.913	0.822	0.365	0.137	0.123	0.055
TPSY227*010#0200	Y	220	10	22	10	200	0.791	0.712	0.316	0.158	0.142	0.063
TPSD337*010#0050	D	330	10	33	8	50	1.732	1.559	0.693	0.087	0.078	0.035
TPSD337*010#0065	D	330	10	33	8	65	1.519	1.367	0.608	0.099	0.089	0.039
TPSD337*010#0100	D	330	10	33	8	100	1.225	1.102	0.490	0.122	0.110	0.049
TPSD337*010#0150	D	330	10	33	8	150	1.000	0.900	0.400	0.150	0.135	0.060
TPSE337*010#0040	E	330	10	33	8	40	2.031	1.828	0.812	0.081	0.073	0.032
TPSE337*010#0050	E	330	10	33	8	50	1.817	1.635	0.727	0.091	0.082	0.036
TPSE337*010#0060	E	330	10	33	8	60	1.658	1.492	0.663	0.099	0.090	0.040
TPSE337*010#0100	E	330	10	33	8	100	1.285	1.156	0.514	0.128	0.116	0.051
TPSV337*010#0040	V	330	10	33	10	40	2.500	2.250	1.000	0.100	0.090	0.040
TPSV337*010#0060	V	330	10	33	10	60	2.041	1.837	0.816	0.122	0.110	0.049
TPSV337*010#0100	V	330	10	33	10	100	1.581	1.423	0.632	0.158	0.142	0.063
TPSE477*010#0045	E	470	10	47	10	45	1.915	1.723	0.766	0.086	0.078	0.034
TPSE477*010#0050	E	470	10	47	10	50	1.817	1.635	0.727	0.091	0.082	0.036
TPSE477*010#0060	E	470	10	47	10	60	1.658	1.492	0.663	0.099	0.090	0.040
TPSE477*010#0100	E	470	10	47	10	100	1.285	1.156	0.514	0.128	0.116	0.051
TPSE477*010#0200	E	470	10	47	10	200	0.908	0.817	0.363	0.182	0.163	0.073
TPSV477*010#0040	V	470	10	47	10	40	2.500	2.250	1.000	0.100	0.090	0.040
TPSV477*010#0060	V	470	10	47	10	60	2.041	1.837	0.816	0.122	0.110	0.049
TPSV477*010#0100	V	470	10	47	10	100	1.581	1.423	0.632	0.158	0.142	0.063
TPSA225*016#1800	A	2.2	16	0.5	6	1800	0.204	0.184	0.082	0.367	0.331	0.147
TPSA225*016#3500	A	2.2	16	0.5	6	3500	0.146	0.132	0.059	0.512	0.461	0.205
TPST225*016#2000	T	2.2	16	0.5	6	2000	0.200	0.180	0.080	0.400	0.360	0.160
TPSA335*016#3500	A	3.3	16	0.5	6	3500	0.146	0.132	0.059	0.512	0.461	0.205
TPSA475*016#2000	A	4.7	16	0.8	6	2000	0.194	0.174	0.077	0.387	0.349	0.155
TPSB475*016#0800	B	4.7	16	0.8	6	800	0.326	0.293	0.130	0.261	0.235	0.104
TPSB475*016#1500	B	4.7	16	0.8	6	1500	0.238	0.214	0.095	0.357	0.321	0.143
TPSA685*016#1500	A	6.8	16	1.1	6	1500	0.224	0.201	0.089	0.335	0.302	0.134
TPSB685*016#0600	B	6.8	16	1.1	6	600	0.376	0.339	0.151	0.226	0.203	0.090
TPSB685*016#1200	B	6.8	16	1.1	6	1200	0.266	0.240	0.106	0.319	0.287	0.128
TPSB106*016#0500	B	10	16	1.6	6	500	0.412	0.371	0.165	0.206	0.186	0.082
TPSB106*016#0800	B	10	16	1.6	6	800	0.326	0.293	0.130	0.261	0.235	0.104
TPSC106*016#0500	C	10	16	1.6	6	500	0.469	0.422	0.188	0.235	0.211	0.094
TPST106*016#0800	T	10	16	1.6	8	800	0.316	0.285	0.126	0.253	0.228	0.101
TPST106*016#1000	T	10	16	1.6	8	1000	0.283	0.255	0.113	0.283	0.255	0.113

All technical data relates to an ambient temperature of +25°C.
 Capacitance and DF are measured at 120Hz, 0.5V RMS with a maximum DC bias of 2.2 volts. DCL is measured at rated voltage after 5 minutes.
 * Insert K for ±10% and M for ±20% Capacitance Tolerance

Standard Plating – Insert R for 7" reel and S for 13" reel
 # **Gold Plating** – Insert A for 7" reel and B for 13" reel
 # **Tin Lead Plating** – Insert H for 7" reel (contact manufacturer)
 # **Tin Lead Plating** – Insert K for 13" reel (contact manufacturer)



TPS Series



Low ESR

RATINGS & PART NUMBER REFERENCE

AVX Part No.	Case Size	Capacitance (μF)	Rated Voltage (V)	DCL (μA) Max.	DF % Max.	ESR Max. (mΩ) @100kHz	100kHz Ripple Current Ratings (A)			100kHz Ripple Voltage Ratings (V)		
							25°C	85°C	125°C	25°C	85°C	125°C
TPSW106*016#0500	W	10	16	1.6	6	500	0.424	0.382	0.170	0.212	0.191	0.085
TPSW106*016#0600	W	10	16	1.6	6	600	0.387	0.349	0.155	0.232	0.209	0.093
TPSB156*016#0500	B	15	16	2.4	6	500	0.412	0.371	0.165	0.206	0.186	0.082
TPSB156*016#0800	B	15	16	2.4	6	800	0.326	0.293	0.130	0.261	0.235	0.104
TPSB226*016#0400	B	22	16	3.5	6	400	0.461	0.415	0.184	0.184	0.166	0.074
TPSB226*016#0600	B	22	16	3.5	6	600	0.376	0.339	0.151	0.226	0.203	0.090
TPSC226*016#0150	C	22	16	3.5	6	150	0.856	0.771	0.343	0.128	0.116	0.051
TPSC226*016#0250	C	22	16	3.5	6	250	0.663	0.597	0.265	0.166	0.149	0.066
TPSC226*016#0300	C	22	16	3.5	6	300	0.606	0.545	0.242	0.182	0.163	0.073
TPSC226*016#0375	C	22	16	3.5	6	375	0.542	0.487	0.217	0.203	0.183	0.081
TPSW226*016#0500	W	22	16	3.5	6	500	0.424	0.382	0.170	0.212	0.191	0.085
TPSB336*016#0350	B	33	16	5.3	8	350	0.493	0.444	0.197	0.172	0.155	0.069
TPSB336*016#0500	B	33	16	5.3	8	500	0.412	0.371	0.165	0.206	0.186	0.082
TPSC336*016#0100	C	33	16	5.3	6	100	1.049	0.944	0.420	0.105	0.094	0.042
TPSC336*016#0150	C	33	16	5.3	6	150	0.856	0.771	0.343	0.128	0.116	0.051
TPSC336*016#0225	C	33	16	5.3	6	225	0.699	0.629	0.280	0.157	0.142	0.063
TPSC336*016#0300	C	33	16	5.3	6	300	0.606	0.545	0.242	0.182	0.163	0.073
TPSD336*016#0200	D	33	16	5.3	6	200	0.866	0.779	0.346	0.173	0.156	0.069
TPSW336*016#0140	W	33	16	5.3	6	140	0.802	0.722	0.321	0.112	0.101	0.045
TPSW336*016#0175	W	33	16	5.3	6	175	0.717	0.645	0.287	0.125	0.113	0.050
TPSW336*016#0250	W	33	16	5.3	6	250	0.600	0.540	0.240	0.150	0.135	0.060
TPSW336*016#0400	W	33	16	5.3	6	400	0.474	0.427	0.190	0.190	0.171	0.076
TPSW336*016#0500	W	33	16	5.3	6	500	0.424	0.382	0.170	0.212	0.191	0.085
TPSY336*016#0300	Y	33	16	5.3	6	300	0.645	0.581	0.258	0.194	0.174	0.077
TPSY336*016#0400	Y	33	16	5.3	6	400	0.559	0.503	0.224	0.224	0.201	0.089
TPSC476*016#0110	C	47	16	7.5	6	110	1.000	0.900	0.400	0.110	0.099	0.044
TPSC476*016#0350	C	47	16	7.5	6	350	0.561	0.505	0.224	0.196	0.177	0.078
TPSD476*016#0080	D	47	16	7.5	6	80	1.369	1.232	0.548	0.110	0.099	0.044
TPSD476*016#0100	D	47	16	7.5	6	100	1.225	1.102	0.490	0.122	0.110	0.049
TPSD476*016#0150	D	47	16	7.5	6	150	1.000	0.900	0.400	0.150	0.135	0.060
TPSD476*016#0200	D	47	16	7.5	6	200	0.866	0.779	0.346	0.173	0.156	0.069
TPSW476*016#0200	W	47	16	7.5	6	200	0.671	0.604	0.268	0.134	0.121	0.054
TPSY476*016#0250	Y	47	16	7.5	6	250	0.707	0.636	0.283	0.176	0.159	0.071
TPSX476*016#0180	X	47	16	7.5	6	180	0.745	0.671	0.298	0.134	0.121	0.054
TPSC686*016#0125	C	68	16	10.9	6	125	0.938	0.844	0.375	0.117	0.106	0.047
TPSC686*016#0200	C	68	16	10.9	6	200	0.742	0.667	0.297	0.148	0.133	0.059
TPSD686*016#0070	D	68	16	10.8	6	70	1.464	1.317	0.586	0.102	0.092	0.041
TPSD686*016#0100	D	68	16	10.9	6	100	1.225	1.102	0.490	0.122	0.110	0.049
TPSD686*016#0150	D	68	16	10.9	6	150	1.000	0.900	0.400	0.150	0.135	0.060
TPSF686*016#0200	F	68	16	10.9	10	200	0.707	0.636	0.283	0.141	0.127	0.057
TPSY686*016#0150	Y	68	16	10.9	6	150	0.913	0.822	0.365	0.137	0.123	0.055
TPSY686*016#0200	Y	68	16	10.9	6	200	0.791	0.712	0.316	0.158	0.142	0.063
TPSY686*016#0250	Y	68	16	10.9	6	250	0.707	0.636	0.283	0.177	0.159	0.071
TPSX686*016#0150	X	68	16	10.9	8	150	0.816	0.735	0.327	0.122	0.110	0.049
TPSD107*016#0060	D	100	16	16	6	60	1.581	1.423	0.632	0.095	0.085	0.038
TPSD107*016#0100	D	100	16	16	6	100	1.225	1.102	0.490	0.122	0.110	0.049
TPSD107*016#0125	D	100	16	16	6	125	1.095	0.986	0.438	0.137	0.123	0.055
TPSD107*016#0150	D	100	16	16	6	150	1.000	0.900	0.400	0.150	0.135	0.060
TPSE107*016#0055	E	100	16	16	6	55	1.732	1.559	0.693	0.095	0.086	0.038
TPSE107*016#0100	E	100	16	16	6	100	1.285	1.156	0.514	0.128	0.116	0.051
TPSE107*016#0125	E	100	16	16	6	125	1.149	1.034	0.460	0.144	0.129	0.057
TPSE107*016#0150	E	100	16	16	6	150	1.049	0.944	0.420	0.157	0.142	0.063
TPSF107M016#0150	F	100	16	16	10	150	0.816	0.735	0.327	0.122	0.110	0.049
TPSF107M016#0200	F	100	16	16	10	200	0.707	0.636	0.283	0.141	0.127	0.057
TPSY107*016#0100	Y	100	16	24	6	100	1.118	1.006	0.447	0.112	0.101	0.045
TPSY107*016#0150	Y	100	16	24	8	150	0.913	0.822	0.365	0.137	0.123	0.055
TPSY107*016#0200	Y	100	16	24	8	200	0.791	0.712	0.316	0.158	0.142	0.063
TPSD157*016#0060	D	150	16	24	6	60	1.581	1.423	0.632	0.095	0.085	0.038
TPSD157*016#0085	D	150	16	24	6	85	1.328	1.196	0.531	0.113	0.102	0.045
TPSD157*016#0100	D	150	16	24	6	100	1.225	1.102	0.490	0.122	0.110	0.049
TPSD157*016#0125	D	150	16	24	6	125	1.095	0.986	0.438	0.137	0.123	0.055
TPSD157*016#0150	D	150	16	24	6	150	1.000	0.900	0.400	0.150	0.135	0.060
TPSE157*016#0100	E	150	16	24	6	100	1.285	1.156	0.514	0.128	0.116	0.051
TPSV157*016#0045	V	150	16	24	8	45	2.357	2.121	0.943	0.106	0.095	0.042
TPSV157*016#0075	V	150	16	24	8	75	1.826	1.643	0.730	0.137	0.123	0.055
TPSY157M016#0200	Y	150	16	24	15	200	0.791	0.712	0.316	0.158	0.142	0.063
TPSE227*016#0100	E	220	16	35.2	10	100	1.285	1.156	0.514	0.128	0.116	0.051
TPSE227*016#0150	E	220	16	35.2	10	150	1.049	0.944	0.420	0.157	0.142	0.063

All technical data relates to an ambient temperature of +25°C.
 Capacitance and DF are measured at 120Hz, 0.5V RMS with a maximum DC bias of 2.2 volts. DCL is measured at rated voltage after 5 minutes.
 * Insert K for ±10% and M for ±20% Capacitance Tolerance

Standard Plating – Insert R for 7" reel and S for 13" reel
 # Gold Plating – Insert A for 7" reel and B for 13" reel
 # Tin Lead Plating – Insert H for 7" reel (contact manufacturer)
 # Tin Lead Plating – Insert K for 13" reel (contact manufacturer)



TPS Series



Low ESR

RATINGS & PART NUMBER REFERENCE

AVX Part No.	Case Size	Capacitance (μF)	Rated Voltage (V)	DCL (μA) Max.	DF % Max.	ESR Max. (mΩ) @100kHz	100kHz Ripple Current Ratings (A)			100kHz Ripple Voltage Ratings (V)		
							25°C	85°C	125°C	25°C	85°C	125°C
TPSV227*016#0050	V	220	16	35.2	8	50	2.236	2.012	0.894	0.112	0.101	0.045
TPSV227*016#0075	V	220	16	35.2	8	75	1.826	1.643	0.730	0.137	0.123	0.055
TPSV227*016#0100	V	220	16	35.2	8	100	1.581	1.423	0.632	0.158	0.142	0.063
TPSV227*016#0150	V	220	16	35.2	8	150	1.291	1.162	0.516	0.194	0.174	0.077
TPSA105*020#3000	A	1	20	0.5	4	3000	0.158	0.142	0.063	0.474	0.427	0.190
TPSS105*020#6000	S	1	20	0.5	4	6000	0.104	0.094	0.042	0.624	0.562	0.250
TPSR105*020#6000	R	1	20	0.5	4	6000	0.096	0.086	0.038	0.574	0.517	0.230
TPST105*020#2000	T	1	20	0.5	4	2000	0.200	0.180	0.080	0.400	0.360	0.160
TPSA225*020#3000	A	2.2	20	0.5	6	3000	0.158	0.142	0.063	0.474	0.427	0.190
TPSA335*020#2500	A	3.3	20	0.7	6	2500	0.173	0.156	0.069	0.433	0.390	0.173
TPSB335*020#1300	B	3.3	20	0.7	6	1300	0.256	0.230	0.102	0.332	0.299	0.133
TPSA475*020#1800	A	4.7	20	0.9	6	1800	0.204	0.184	0.082	0.367	0.331	0.147
TPSB475*020#0750	B	4.7	20	0.9	6	750	0.337	0.303	0.135	0.252	0.227	0.101
TPSB475*020#1000	B	4.7	20	0.9	6	1000	0.292	0.262	0.117	0.292	0.262	0.117
TPSA685*020#1000	A	6.8	20	1.4	6	1000	0.274	0.246	0.110	0.274	0.246	0.110
TPSB685*020#0600	B	6.8	20	1.4	6	600	0.376	0.339	0.151	0.226	0.203	0.090
TPSB685*020#1000	B	6.8	20	1.4	6	1000	0.292	0.262	0.117	0.292	0.262	0.117
TPSC685*020#0700	C	6.8	20	1.4	6	700	0.396	0.357	0.159	0.277	0.250	0.111
TPSB106*020#0500	B	10	20	2	6	500	0.412	0.371	0.165	0.206	0.186	0.082
TPSB106*020#1000	B	10	20	2	6	1000	0.292	0.262	0.117	0.292	0.262	0.117
TPSC106*020#0500	C	10	20	2	6	500	0.469	0.422	0.188	0.235	0.211	0.094
TPSC106*020#0700	C	10	20	2	6	700	0.396	0.357	0.159	0.277	0.250	0.111
TPSB156*020#0500	B	15	20	3	6	500	0.412	0.371	0.165	0.206	0.186	0.082
TPSC156*020#0400	C	15	20	3	6	400	0.524	0.472	0.210	0.210	0.189	0.084
TPSC156*020#0450	C	15	20	3	6	450	0.494	0.445	0.198	0.222	0.200	0.089
TPSB226*020#0400	B	22	20	4.4	6	400	0.461	0.415	0.184	0.184	0.166	0.074
TPSB226*020#0600	B	22	20	4.4	6	600	0.376	0.339	0.151	0.226	0.203	0.090
TPSC226*020#0100	C	22	20	4.4	6	100	1.049	0.944	0.420	0.105	0.094	0.042
TPSC226*020#0150	C	22	20	4.4	6	150	0.856	0.771	0.343	0.128	0.116	0.051
TPSC226*020#0400	C	22	20	4.4	6	400	0.524	0.472	0.210	0.210	0.189	0.084
TPSD226*020#0200	D	22	20	4.4	6	200	0.866	0.779	0.346	0.173	0.156	0.069
TPSD226*020#0300	D	22	20	4.4	6	300	0.707	0.636	0.283	0.212	0.191	0.085
TPSC336*020#0300	C	33	20	6.6	6	300	0.606	0.545	0.242	0.182	0.163	0.073
TPSD336*020#0100	D	33	20	6.6	6	100	1.225	1.102	0.490	0.122	0.110	0.049
TPSD336*020#0200	D	33	20	6.6	6	200	0.866	0.779	0.346	0.173	0.155	0.069
TPSD476*020#0075	D	47	20	9.4	6	75	1.414	1.273	0.566	0.106	0.095	0.042
TPSD476*020#0100	D	47	20	9.4	6	100	1.225	1.102	0.490	0.122	0.110	0.049
TPSD476*020#0200	D	47	20	9.4	6	200	0.866	0.779	0.346	0.173	0.156	0.069
TPSE476*020#0070	E	47	20	9.4	6	70	1.535	1.382	0.614	0.107	0.097	0.043
TPSE476*020#0125	E	47	20	9.4	6	125	1.149	1.034	0.460	0.144	0.129	0.057
TPSE476*020#0150	E	47	20	9.4	6	150	1.049	0.944	0.420	0.157	0.142	0.063
TPSE476*020#0200	E	47	20	9.4	6	200	0.908	0.817	0.363	0.182	0.163	0.073
TPSE476*020#0250	E	47	20	9.4	6	250	0.812	0.731	0.325	0.203	0.183	0.081
TPSD686*020#0070	D	68	20	13.6	6	70	1.464	1.317	0.586	0.102	0.092	0.041
TPSD686*020#0150	D	68	20	13.6	6	150	1.000	0.900	0.400	0.150	0.135	0.060
TPSD686*020#0200	D	68	20	13.6	6	200	0.866	0.779	0.346	0.173	0.156	0.069
TPSD686*020#0300	D	68	20	13.6	6	300	0.707	0.636	0.283	0.212	0.191	0.085
TPSE686*020#0125	E	68	20	13.6	6	125	1.149	1.034	0.460	0.144	0.129	0.057
TPSE686*020#0150	E	68	20	13.6	6	150	1.049	0.944	0.420	0.157	0.142	0.063
TPSE686*020#0200	E	68	20	13.6	6	200	0.908	0.817	0.363	0.182	0.163	0.073
TPSD107*020#0085	D	100	20	20	6	85	1.328	1.196	0.531	0.113	0.102	0.045
TPSD107*020#0100	D	100	20	20	6	100	1.225	1.102	0.490	0.122	0.110	0.049
TPSD107*020#0150	D	100	20	20	6	150	1.000	0.900	0.400	0.150	0.135	0.060
TPSE107*020#0100	E	100	20	20	6	100	1.285	1.156	0.514	0.128	0.116	0.051
TPSE107*020#0150	E	100	20	20	6	150	1.049	0.944	0.420	0.157	0.142	0.063
TPSE107*020#0200	E	100	20	20	6	200	0.908	0.817	0.363	0.182	0.163	0.073
TPSV107*020#0060	V	100	20	20	8	60	2.041	1.837	0.816	0.122	0.110	0.049
TPSV107*020#0085	V	100	20	20	8	85	1.715	1.543	0.686	0.146	0.131	0.058
TPSV107*020#0100	V	100	20	20	8	100	1.581	1.423	0.632	0.158	0.142	0.063
TPSV107*020#0200	V	100	20	20	8	200	1.118	1.006	0.447	0.224	0.201	0.089
TPSV157*020#0080	V	150	20	30	8	80	1.768	1.591	0.707	0.141	0.127	0.057
TPSA474*025#7000	A	0.47	25	0.5	4	7000	0.104	0.093	0.041	0.725	0.652	0.290
TPSA684*025#6000	A	0.68	25	0.5	4	6000	0.112	0.101	0.045	0.671	0.604	0.268
TPSR105*025#2500	R	1	25	0.5	4	2500	0.148	0.133	0.059	0.371	0.334	0.148
TPSR105*025#4000	R	1	25	0.5	4	4000	0.117	0.106	0.047	0.469	0.422	0.188
TPSA155*025#3000	A	1.5	25	0.5	6	3000	0.158	0.142	0.063	0.474	0.427	0.190
TPSB155*025#1800	B	1.5	25	0.5	6	1800	0.217	0.196	0.087	0.391	0.352	0.156
TPSB225*025#0900	B	2.2	25	0.6	6	900	0.307	0.277	0.123	0.277	0.249	0.111

All technical data relates to an ambient temperature of +25°C.
 Capacitance and DF are measured at 120Hz, 0.5V RMS with a maximum DC bias of 2.2 volts. DCL is measured at rated voltage after 5 minutes.
 * Insert K for ±10% and M for ±20% Capacitance Tolerance

Standard Plating – Insert R for 7" reel and S for 13" reel
 # **Gold Plating** – Insert A for 7" reel and B for 13" reel
 # **Tin Lead Plating** – Insert H for 7" reel (contact manufacturer)
 # **Tin Lead Plating** – Insert K for 13" reel (contact manufacturer)



TPS Series



Low ESR

RATINGS & PART NUMBER REFERENCE

AVX Part No.	Case Size	Capacitance (μF)	Rated Voltage (V)	DCL (μA) Max.	DF % Max.	ESR Max. (mΩ) @100kHz	100kHz Ripple Current Ratings (A)			100kHz Ripple Voltage Ratings (V)		
							25°C	85°C	125°C	25°C	85°C	125°C
TPSB225*025#1200	B	2.2	25	0.6	6	1200	0.266	0.240	0.106	0.319	0.287	0.128
TPSB225*025#2500	B	2.2	25	0.6	6	2500	0.184	0.166	0.074	0.461	0.415	0.184
TPSA335*025#1000	A	3.3	25	0.8	6	1000	0.274	0.246	0.110	0.274	0.246	0.110
TPSA335*025#1500	A	3.3	25	0.8	6	1500	0.224	0.201	0.089	0.335	0.302	0.134
TPSB335*025#0750	B	3.3	25	0.8	6	750	0.337	0.303	0.135	0.252	0.227	0.101
TPSB335*025#1500	B	3.3	25	0.8	6	1500	0.238	0.214	0.095	0.357	0.321	0.143
TPSB335*025#2000	B	3.3	25	0.8	6	2000	0.206	0.186	0.082	0.412	0.371	0.165
TPSB475*025#0700	B	4.7	25	1.2	6	700	0.348	0.314	0.139	0.244	0.220	0.098
TPSB475*025#0900	B	4.7	25	1.2	6	900	0.307	0.277	0.123	0.277	0.249	0.111
TPSB475*025#1500	B	4.7	25	1.2	6	1500	0.238	0.214	0.095	0.357	0.321	0.143
TPSB685*025#0700	B	6.8	25	1.7	6	700	0.348	0.314	0.139	0.244	0.220	0.098
TPSC685*025#0500	C	6.8	25	1.7	6	500	0.469	0.422	0.188	0.235	0.211	0.094
TPSC685*025#0600	C	6.8	25	1.7	6	600	0.428	0.385	0.171	0.257	0.231	0.103
TPSC685*025#0700	C	6.8	25	1.7	6	700	0.396	0.357	0.159	0.277	0.250	0.111
TPSC106*025#0300	C	10	25	2.5	6	300	0.606	0.545	0.242	0.182	0.163	0.073
TPSC106*025#0500	C	10	25	2.5	6	500	0.469	0.422	0.188	0.235	0.211	0.094
TPSC156*025#0220	C	15	25	3.8	6	220	0.707	0.636	0.283	0.156	0.140	0.062
TPSC156*025#0300	C	15	25	3.8	6	300	0.606	0.545	0.242	0.182	0.163	0.073
TPSD156*025#0100	D	15	25	3.8	6	100	1.225	1.102	0.490	0.122	0.110	0.049
TPSD156*025#0300	D	15	25	3.8	6	300	0.707	0.636	0.283	0.212	0.191	0.085
TPSC226*025#0275	C	22	25	5.5	6	275	0.632	0.569	0.253	0.174	0.157	0.070
TPSC226*025#0400	C	22	25	5.5	6	400	0.524	0.472	0.210	0.210	0.189	0.084
TPSD226*025#0100	D	22	25	5.5	6	100	1.225	1.102	0.490	0.122	0.110	0.049
TPSD226*025#0200	D	22	25	5.5	6	200	0.866	0.779	0.346	0.173	0.156	0.069
TPSD226*025#0300	D	22	25	5.5	6	300	0.707	0.636	0.283	0.212	0.191	0.085
TPSD336*025#0100	D	33	25	8.3	6	100	1.225	1.102	0.490	0.122	0.110	0.049
TPSD336*025#0200	D	33	25	8.3	6	200	0.866	0.779	0.346	0.173	0.156	0.069
TPSD336*025#0300	D	33	25	8.3	6	300	0.707	0.636	0.283	0.212	0.191	0.085
TPSE336*025#0100	E	33	25	8.3	6	100	1.285	1.156	0.514	0.128	0.116	0.051
TPSE336*025#0175	E	33	25	8.3	6	175	0.971	0.874	0.388	0.170	0.153	0.068
TPSE336*025#0200	E	33	25	8.3	6	200	0.908	0.817	0.363	0.182	0.163	0.073
TPSE336*025#0300	E	33	25	8.3	6	300	0.742	0.667	0.297	0.222	0.200	0.089
TPSY336*025#0200	Y	33	25	8.3	6	200	0.791	0.712	0.316	0.158	0.142	0.063
TPSD476*025#0125	D	47	25	11.8	6	125	1.095	0.986	0.438	0.137	0.123	0.055
TPSD476*025#0150	D	47	25	11.8	6	150	1.000	0.900	0.400	0.150	0.135	0.060
TPSD476*025#0250	D	47	25	11.8	6	250	0.775	0.697	0.310	0.194	0.174	0.077
TPSE476*025#0080	E	47	25	8.3	6	80	1.436	1.293	0.574	0.115	0.103	0.046
TPSE476*025#0100	E	47	25	8.3	6	100	1.285	1.156	0.514	0.128	0.116	0.051
TPSE476*025#0125	E	47	25	8.3	6	125	1.149	1.034	0.460	0.144	0.129	0.057
TPSE686*025#0125	E	68	25	17	6	125	1.149	1.034	0.460	0.144	0.129	0.057
TPSE686*025#0200	E	68	25	17	6	200	0.908	0.817	0.363	0.182	0.163	0.073
TPSV686*025#0080	V	68	25	17	6	80	1.768	1.591	0.707	0.141	0.127	0.057
TPSV686*025#0095	V	68	25	17	6	95	1.622	1.460	0.649	0.154	0.139	0.062
TPSV686*025#0150	V	68	25	17	6	150	1.291	1.162	0.516	0.194	0.174	0.077
TPSV686*025#0200	V	68	25	17	6	200	1.118	1.006	0.447	0.224	0.201	0.089
TPSV107*025#0100	V	100	25	25	8	100	1.581	1.423	0.632	0.158	0.142	0.063
TPSA224*035#6000	A	0.22	35	0.5	4	6000	0.112	0.101	0.045	0.671	0.604	0.268
TPSA334*035#6000	A	0.33	35	0.5	4	6000	0.112	0.101	0.045	0.671	0.604	0.268
TPSA474*035#6000	A	0.47	35	0.5	4	6000	0.112	0.101	0.045	0.671	0.604	0.268
TPSB474*035#4000	B	0.47	35	0.5	4	4000	0.146	0.131	0.058	0.583	0.525	0.233
TPSA684*035#6000	A	0.68	35	0.5	4	6000	0.112	0.101	0.045	0.671	0.604	0.268
TPSA105*035#3000	A	1	35	0.5	4	3000	0.158	0.142	0.063	0.474	0.427	0.190
TPSB105*035#2000	B	1	35	0.5	4	2000	0.206	0.186	0.082	0.412	0.371	0.165
TPSB155*035#2500	B	1.5	35	0.5	6	2500	0.184	0.166	0.074	0.461	0.415	0.184
TPSA225*035#1500	A	2.2	35	0.8	6	1500	0.224	0.201	0.089	0.335	0.302	0.134
TPSB225*035#0750	B	2.2	35	0.8	6	750	0.337	0.303	0.135	0.252	0.227	0.101
TPSB225*035#1500	B	2.2	35	0.8	6	1500	0.238	0.214	0.095	0.357	0.321	0.143
TPSB225*035#2000	B	2.2	35	0.8	6	2000	0.206	0.186	0.082	0.412	0.371	0.165
TPSC225*035#1000	C	2.2	35	0.8	6	1000	0.332	0.298	0.133	0.332	0.298	0.133
TPSB335*035#1000	B	3.3	35	1.2	6	1000	0.292	0.262	0.117	0.292	0.262	0.117
TPSC335*035#0700	C	3.3	35	1.2	6	700	0.396	0.357	0.159	0.277	0.250	0.111
TPSB475*035#0700	B	4.7	35	1.2	6	700	0.348	0.314	0.139	0.244	0.220	0.098
TPSB475*035#1500	B	4.7	35	1.2	6	1500	0.238	0.214	0.095	0.357	0.321	0.143
TPSC475*035#0600	C	4.7	35	1.6	6	600	0.428	0.385	0.171	0.257	0.231	0.103
TPSC685*035#0350	C	6.8	35	2.4	6	350	0.561	0.505	0.224	0.196	0.177	0.078
TPSD685*035#0150	D	6.8	35	2.4	6	150	1.000	0.900	0.400	0.150	0.135	0.060
TPSD685*035#0400	D	6.8	35	2.4	6	400	0.612	0.551	0.245	0.245	0.220	0.098
TPSD685*035#0500	D	6.8	35	2.4	6	500	0.548	0.493	0.219	0.274	0.246	0.110

All technical data relates to an ambient temperature of +25°C.
 Capacitance and DF are measured at 120Hz, 0.5V RMS with a maximum DC bias of 2.2 volts. DCL is measured at rated voltage after 5 minutes.
 * Insert K for ±10% and M for ±20% Capacitance Tolerance

Standard Plating – Insert R for 7" reel and S for 13" reel
 # **Gold Plating** – Insert A for 7" reel and B for 13" reel
 # **Tin Lead Plating** – Insert H for 7" reel (contact manufacturer)
 # **Tin Lead Plating** – Insert K for 13" reel (contact manufacturer)



RATINGS & PART NUMBER REFERENCE

AVX Part No.	Case Size	Capacitance (μF)	Rated Voltage (V)	DCL (μA) Max.	DF % Max.	ESR Max. (mΩ) @100kHz	100kHz Ripple Current Ratings (A)			100kHz Ripple Voltage Ratings (V)		
							25°C	85°C	125°C	25°C	85°C	125°C
TPSD106*035#0125	D	10	35	3.5	6	125	1.095	0.986	0.438	0.137	0.123	0.055
TPSD106*035#0300	D	10	35	3.5	6	300	0.707	0.636	0.283	0.212	0.191	0.085
TPSE106*035#0200	E	10	35	3.5	6	200	0.908	0.817	0.363	0.182	0.163	0.073
TPSC156*035#0350	C	15	35	5.3	6	350	0.561	0.505	0.224	0.196	0.177	0.078
TPSC156*035#0450	C	15	35	5.3	6	450	0.494	0.445	0.198	0.222	0.200	0.089
TPSD156*035#0100	D	15	35	5.3	6	100	1.225	1.102	0.490	0.122	0.110	0.049
TPSD156*035#0300	D	15	35	5.3	6	300	0.707	0.636	0.283	0.212	0.191	0.085
TPSY156*035#0250	Y	15	35	5.3	6	250	0.707	0.636	0.283	0.177	0.159	0.071
TPSD226*035#0125	D	22	35	7.7	6	125	1.095	0.986	0.438	0.137	0.123	0.055
TPSD226*035#0200	D	22	35	7.7	6	200	0.866	0.779	0.346	0.173	0.156	0.069
TPSD226*035#0300	D	22	35	7.7	6	300	0.707	0.636	0.283	0.212	0.191	0.085
TPSD226*035#0400	D	22	35	7.7	6	400	0.612	0.551	0.245	0.245	0.220	0.098
TPSE226*035#0125	E	22	35	7.7	6	125	1.149	1.034	0.460	0.144	0.129	0.057
TPSE226*035#0200	E	22	35	7.7	6	200	0.908	0.817	0.363	0.182	0.163	0.073
TPSE226*035#0300	E	22	35	7.7	6	300	0.742	0.667	0.297	0.222	0.200	0.089
TPSY226*035#0200	Y	22	35	7.7	6	200	0.791	0.712	0.316	0.158	0.142	0.063
TPSD336*035#0200	D	33	35	11.6	6	200	0.866	0.779	0.346	0.173	0.156	0.069
TPSD336*035#0300	D	33	35	11.6	6	300	0.707	0.636	0.283	0.212	0.191	0.085
TPSE336*035#0100	E	33	35	11.6	6	100	1.285	1.156	0.514	0.128	0.116	0.051
TPSE336*035#0250	E	33	35	11.6	6	250	0.812	0.731	0.325	0.203	0.183	0.081
TPSE336*035#0300	E	33	35	11.6	6	300	0.742	0.667	0.297	0.222	0.200	0.089
TPSV336*035#0200	V	33	35	11.6	6	200	1.118	1.006	0.447	0.224	0.201	0.089
TPSE476*035#0200	E	47	35	16.5	6	200	0.908	0.817	0.363	0.182	0.163	0.073
TPSE476*035#0250	E	47	35	16.5	6	250	0.812	0.731	0.325	0.203	0.183	0.081
TPSV476*035#0150	V	47	35	16.5	6	150	1.291	1.162	0.516	0.194	0.174	0.077
TPSV476*035#0200	V	47	35	16.5	6	200	1.118	1.006	0.447	0.224	0.201	0.089
TPSV686M035#0150	V	68	35	23.8	6	150	1.291	1.162	0.516	0.194	0.174	0.077
TPSV686M035#0200	V	68	35	23.8	6	200	1.118	1.006	0.447	0.224	0.201	0.089
TPSA154*050#9000	A	0.15	50	0.5	4	9000	0.091	0.082	0.037	0.822	0.739	0.329
TPSA224*050#7000	A	0.22	50	0.5	4	7000	0.104	0.093	0.041	0.725	0.652	0.290
TPSC105*050#2500	C	1	50	0.5	4	2500	0.210	0.189	0.084	0.524	0.472	0.210
TPSC155*050#1500	C	1.5	50	0.8	6	1500	0.271	0.244	0.108	0.406	0.366	0.162
TPSC155*050#2000	C	1.5	50	0.8	6	2000	0.235	0.211	0.094	0.469	0.422	0.188
TPSD225*050#1200	D	2.2	50	1.1	6	1200	0.354	0.318	0.141	0.424	0.382	0.170
TPSD335*050#0800	D	3.3	50	1.7	6	800	0.433	0.390	0.173	0.346	0.312	0.139
TPSD475*050#0300	D	4.7	50	2.4	6	300	0.707	0.636	0.283	0.212	0.191	0.085
TPSD475*050#0500	D	4.7	50	2.4	6	500	0.548	0.493	0.219	0.274	0.246	0.110
TPSD475*050#0700	D	4.7	50	2.4	6	700	0.463	0.417	0.185	0.324	0.292	0.130
TPSD685*050#0200	D	6.8	50	3.4	6	200	0.866	0.779	0.346	0.173	0.156	0.069
TPSD685*050#0300	D	6.8	50	3.4	6	300	0.707	0.636	0.283	0.212	0.191	0.085
TPSD685*050#0500	D	6.8	50	3.4	6	500	0.548	0.493	0.219	0.274	0.246	0.110
TPSD685*050#0600	D	6.8	50	3.4	6	600	0.500	0.450	0.200	0.300	0.270	0.120
TPSE106*050#0400	E	10	50	5	6	400	0.642	0.578	0.257	0.257	0.231	0.103
TPSE106*050#0500	E	10	50	5	6	500	0.574	0.517	0.230	0.287	0.259	0.115
TPSE156*050#0250	E	15	50	5	6	250	0.812	0.731	0.325	0.203	0.183	0.081

All technical data relates to an ambient temperature of +25°C.
 Capacitance and DF are measured at 120Hz, 0.5V RMS with a maximum DC bias of 2.2 volts. DCL is measured at rated voltage after 5 minutes.
 * Insert K for ±10% and M for ±20% Capacitance Tolerance

Standard Plating – Insert R for 7" reel and S for 13" reel
 # **Gold Plating** – Insert A for 7" reel and B for 13" reel
 # **Tin Lead Plating** – Insert H for 7" reel (contact manufacturer)
 # **Tin Lead Plating** – Insert K for 13" reel (contact manufacturer)

TPS Series III

New Generation Low ESR



Current application trends in circuit designs for switch-mode power supplies, micro-processors, and digital circuits call for higher operating frequencies and smoother filtering. In order to function properly, components with low ESR, high capacitance and high reliability are required. The New Third generation TPS Low ESR series is based on the traditional MnO₂ process

that offers very low ESR levels previously only seen by other technologies. Further, continuous improvements in MnO₂ technology has allowed reductions in the resistance of the capacitor electrodes in order to further reduce ESR levels. Traditional MnO₂ technology guarantees excellent line and field performance, humidity stability and high electrical and thermal stress resistance.

CASE DIMENSIONS: millimeters (inches)

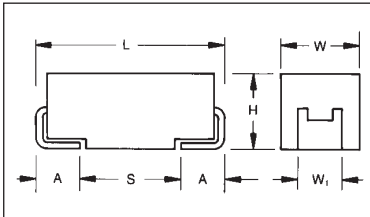

For part marking see page 164

Code	EIA Code	L±0.20 (0.008)	W+0.20 (0.008) -0.10 (0.004)	H+0.20 (0.008) -0.10 (0.004)	W ₁ ±0.20 (0.008)	A+0.30 (0.012) -0.20 (0.008)	S Min.
B	3528-21	3.50 (0.138)	2.80 (0.110)	1.90 (0.075)	2.20 (0.087)	0.80 (0.031)	1.40 (0.055)
C	6032-28	6.00 (0.236)	3.20 (0.126)	2.60 (0.102)	2.20 (0.087)	1.30 (0.051)	2.90 (0.114)
D	7343-31	7.30 (0.287)	4.30 (0.169)	2.90 (0.114)	2.40 (0.094)	1.30 (0.051)	4.40 (0.173)
E	7343-43	7.30 (0.287)	4.30 (0.169)	4.10 (0.162)	2.40 (0.094)	1.30 (0.051)	4.40 (0.173)
V	7361-38	7.30 (0.287)	6.10 (0.240)	3.45±0.30 (0.136±0.012)	3.10 (0.120)	1.40 (0.055)	1.80 (0.071)
W*	6032-15	6.00 (0.236)	3.20 (0.126)	1.50 (0.059) max.	2.20 (0.087)	1.30 (0.051)	2.90 (0.114)
Y**	7343-20	7.30 (0.287)	4.30 (0.169)	2.00 (0.079) max.	2.40 (0.094)	1.30 (0.051)	4.40 (0.173)

W₁ dimension applies to the termination width for A dimensional area only.

* Low Profile Version of C Case (max. height 1.5 [0.059])

** Low Profile Version of D Case (max. height 2.0 [0.079])

HOW TO ORDER

TPS

Type

D

Case Size
See table above

227

Capacitor Code
pF code: 1st two digits represent significant figures, 3rd digit represents multiplier (number of zeros to follow)

K

Capacitance Tolerance
K=±10%
M=±20%

010

Rated DC Voltage
002=2.5Vdc
004=4Vdc
006=6.3Vdc
010=10Vdc
016=16Vdc
020=20Vdc
025=25Vdc
035=35Vdc
050=50Vdc

R

Packaging
R = 7" T/R
(Lead Free since production date 1/1/04)
S = 13" T/R
(Lead Free since production date 1/1/04)
A = Gold Plating
7" Reel
B = Gold Plating
13" Reel

0050

Maximum ESR in Milliohms
See note below

NOTE: The EIA & CECC standards for low ESR Solid Tantalum Capacitors allow an ESR movement to 1.25 times catalog limit post mounting.

TECHNICAL SPECIFICATIONS

Technical Data:

All technical data relate to an ambient temperature of +25°C

Capacitance Range: 4.7 µF to 1500 µF

Capacitance Tolerance: ±10%; ±20%

Rated Voltage (V _R)	≤ +85°C:	2.5	4	6.3	10	16	20	25	35	50
Category Voltage (V _C)	≤ +125°C:	1.7	2.7	4	7	10	13	17	23	33
Surge Voltage (V _S)	≤ +85°C:	3.3	5.2	8	13	20	26	32	46	65
Surge Voltage (V _S)	≤ +125°C:	2.2	3.4	5	8	13	16	20	28	40

Temperature Range: -55°C to +125°C

Environmental Classification: 55/125/56 (IEC 68-2)

Reliability: 1% per 1000 hours at 85°C, V_R with 0.1/V series impedance, 60% confidence level

Meets requirements of AEC-Q200



TPS Series III



New Generation Low ESR

**CAPACITANCE AND RATED VOLTAGE, V_R (VOLTAGE CODE) RANGE
LETTER DENOTES CASE SIZE (ESR in m Ω)**

SERIES III MATRIX

Capacitance		Rated Voltage DC (V_R) to 85°C								
μ F	Code	2.5V (e)	4V (G)	6.3V (J)	10V (A)	16V (C)	20V (D)	25V (E)	35V (V)	50V (T)
4.7	475									D(300)
6.8	685									
10	106								D(125)	
15	156							D(100)	D(100)	
22	226					C(150)	C(100)	D(100)	D(125) E(125)	
33	336				C(150)	W(140)	D(100)	D(100) E(100)	D(200) E(100) V(80)	
47	476			B(250)	W(125)	D(80)	D(75) E(70)	E(80)	V(100)	
68	686			W(110)	Y(70,100)	D(70)	D(70)	E(125) V(80)		
100	107			C(75) Y(65,100)	C(75) D(50) Y(65,100)	D(60) E(55) Y(65,100)	V(60)			
150	157			D(50)	D(50) Y(65,100)	E(50) V(45)				
220	227	D(45)	D(40)	D(50) Y(65,100)	D(50) E(50)	V(45,50)				
330	337		D(35)	D(45)	E(40) V(40)					
470	477		D(45) E(35)	E(45)	E(45) V(40)					
680	687		E(40)	E(45) V(35)						
1000	108	E(30)	V(25) E(40)							
1500	158	V(30)								

Red - Developmental Ratings - subject to change

For TPS series and the case sizes C, D and E the ESR limits are printed on capacitor side in the following format:

T x x x - where x x x is ESR limit in milliohms i.e. T100 represents max. ESR of 100 milliohms.

ESR limits quoted in brackets (milliohms)

NOTE: The EIA & CECC standards for low ESR Solid Tantalum Capacitors allow an ESR movement to 1.25 times catalog limit post mounting.



TPS Series III



New Generation Low ESR

RATINGS & PART NUMBER REFERENCE

AVX Part No.	Case Size	Capacitance (μF)	Rated Voltage (V)	DCL (μA) Max.	DF % Max.	ESR Max. (mΩ) @100kHz	100kHz Ripple Current Ratings (A)			100kHz Ripple Voltage Ratings (V)		
							25°C	85°C	125°C	25°C	85°C	125°C
TPSD227*002#0045	D	220	2.5	4.4	8	45	1.826	1.643	0.730	0.082	0.074	0.033
TPSE108*002#0030	E	1000	2.5	20	14	30	2.345	2.111	0.938	0.070	0.063	0.028
TPSV158*002#0030	V	1500	2.5	30	20	30	2.887	2.598	1.155	0.087	0.078	0.035
TPSD227*004#0040	D	220	4	8.8	8	40	1.936	1.743	0.775	0.077	0.070	0.031
TPSD337*004#0035	D	330	4	13.2	8	35	2.070	1.863	0.828	0.072	0.065	0.029
TPSD477*004#0045	D	470	4	18.8	12	45	1.826	1.643	0.730	0.082	0.074	0.033
TPSE477*004#0035	E	470	4	18.8	10	35	2.171	1.954	0.868	0.076	0.068	0.030
TPSE687*004#0040	E	680	4	27.2	10	40	2.031	1.828	0.812	0.081	0.073	0.032
TPSV108*004#0025	V	1000	4	40	16	25	3.162	2.846	1.265	0.079	0.071	0.032
TPSB476*006#0250	B	47	6.3	3	6	250	0.583	0.525	0.233	0.146	0.131	0.058
TPSW686*006#0110	W	68	6.3	4.3	6	110	0.905	0.814	0.362	0.099	0.090	0.040
TPSC107*006#0075	C	100	6.3	6.3	6	75	1.211	1.090	0.484	0.091	0.082	0.036
TPSY107*006#0100	Y	100	6.3	6.3	6	100	1.118	1.006	0.447	0.112	0.101	0.045
TPSD157*006#0050	D	150	6.3	9.5	6	50	1.732	1.559	0.693	0.087	0.078	0.035
TPSD227*006#0050	D	220	6.3	13.9	8	50	1.732	1.559	0.693	0.087	0.078	0.035
TPSY108*006#0100	Y	220	6.3	13.9	10	100	1.118	1.006	0.447	0.112	0.101	0.045
TPSD337*006#0045	D	330	6.3	20.8	8	45	1.826	1.643	0.730	0.082	0.074	0.033
TPSE477*006#0045	E	470	6.3	29.6	10	45	1.915	1.723	0.766	0.086	0.078	0.034
TPSE687*006#0045	E	680	6.3	42.8	10	45	1.915	1.723	0.766	0.086	0.078	0.034
TPSV687*006#0035	V	680	6.3	42.8	14	35	2.673	2.405	1.069	0.094	0.084	0.037
TPSC336*010#0150	C	33	10	3.3	6	150	0.856	0.771	0.343	0.128	0.116	0.051
TPSW476*010#0125	W	47	10	4.7	6	125	0.849	0.764	0.339	0.106	0.095	0.042
TPSY686*010#0100	Y	68	10	6.8	6	100	1.118	1.006	0.447	0.112	0.101	0.045
TPSC107*010#0075	C	100	10	10	8	75	1.211	1.090	0.484	0.091	0.082	0.036
TPSD107*010#0050	D	100	10	10	6	50	1.732	1.559	0.693	0.087	0.078	0.035
TPSY107*010#0100	Y	100	10	10	6	100	1.118	1.006	0.447	0.112	0.101	0.045
TPSD157*010#0050	D	150	10	15	6	50	1.732	1.559	0.693	0.087	0.078	0.035
TPSY157*010#0100	Y	150	10	15	6	100	1.118	1.006	0.447	0.112	0.101	0.045
TPSD227*010#0050	D	220	10	22	8	50	1.732	1.559	0.693	0.087	0.078	0.035
TPSE227*010#0050	E	220	10	22	8	50	1.817	1.635	0.727	0.091	0.082	0.036
TPSE337*010#0040	E	330	10	33	8	40	2.031	1.828	0.812	0.081	0.073	0.032
TPSV337*010#0040	V	330	10	33	10	40	2.500	1.250	1.000	0.100	0.090	0.040
TPSE477*010#0045	E	470	10	47	10	45	1.915	1.723	0.766	0.086	0.078	0.034
TPSV477*010#0040	V	470	10	47	10	40	2.500	2.250	1.000	0.100	0.090	0.040
TPSC226*016#0150	C	22	16	3.5	6	150	0.856	0.771	0.343	0.128	0.116	0.051
TPSW336*016#0140	W	33	16	5.3	6	140	0.802	0.722	0.321	0.112	0.101	0.045
TPSD476*016#0080	D	47	16	7.5	6	80	1.369	1.232	0.548	0.110	0.099	0.044
TPSD686*016#0070	D	68	16	10.8	6	70	1.464	1.317	0.586	0.102	0.092	0.041
TPSD107*016#0060	D	100	16	16	6	60	1.581	1.423	0.632	0.095	0.085	0.038
TPSE107*016#0055	E	100	16	16	6	55	1.732	1.559	0.693	0.095	0.086	0.038
TPSY107*016#0100	Y	100	16	16	8	100	1.118	1.006	0.447	0.112	0.101	0.045
TPSV157*016#0045	V	150	16	24	6	45	2.357	2.121	0.943	0.106	0.095	0.042
TPSV227*016#0050	V	220	16	35.2	8	50	2.236	2.012	0.894	0.112	0.101	0.045

All technical data relates to an ambient temperature of +25°C.
 Capacitance and DF are measured at 120Hz, 0.5V RMS with a maximum DC bias of 2.2 volts. DCL is measured at rated voltage after 5 minutes.
 * Insert K for ±10% and M for ±20% Capacitance Tolerance

Standard Plating – Insert R for 7" reel and S for 13" reel
 # Gold Plating – Insert A for 7" reel and B for 13" reel

NOTE: AVX reserves the right to supply a higher voltage rating or tighter tolerance part in the same case size, to the same reliability standards.



TPS Series III

New Generation Low ESR



RATINGS & PART NUMBER REFERENCE

AVX Part No.	Case Size	Capacitance (μF)	Rated Voltage (V)	DCL (μA) Max.	DF % Max.	ESR Max. (mΩ) @100kHz	100kHz Ripple Current Ratings (A)			100kHz Ripple Voltage Ratings (V)		
							25°C	85°C	125°C	25°C	85°C	125°C
TPSC226*020#0100	C	22	20	4.4	6	100	1.049	0.944	0.420	0.105	0.094	0.042
TPSD336*020#0100	D	33	20	6.6	6	100	1.225	1.102	0.490	0.122	0.110	0.049
TPSD476*020#0075	D	47	20	9.4	6	75	1.414	1.273	0.566	0.106	0.095	0.042
TPSE476*020#0070	E	47	20	9.4	6	70	1.535	1.382	0.614	0.107	0.097	0.043
TPSD686*020#0070	D	68	20	13.6	6	70	1.464	1.317	0.586	0.102	0.092	0.041
TPSV107*020#0060	V	100	20	20	8	60	2.041	1.837	0.816	0.122	0.110	0.049
TPSD156*025#0100	D	15	25	3.8	6	100	1.225	1.102	0.490	0.122	0.110	0.049
TPSD226*025#0100	D	22	25	5.5	6	100	1.225	1.102	0.490	0.122	0.110	0.049
TPSD336*025#0100	D	33	25	8.3	6	100	1.225	1.102	0.490	0.122	0.110	0.049
TPSE336*025#0100	E	33	25	8.3	6	100	1.285	1.156	0.514	0.128	0.116	0.051
TPSE476*025#0080	E	47	25	8.3	6	80	1.436	1.293	0.574	0.115	0.103	0.046
TPSE686*025#0125	E	68	25	17	6	125	1.149	1.034	0.460	0.144	0.129	0.057
TPSV686*025#0080	V	68	25	17	6	80	1.768	1.591	0.707	0.141	0.127	0.057
TPSD106*035#0125	D	10	35	3.5	6	125	1.095	0.986	0.438	0.137	0.123	0.055
TPSD156*035#0100	D	15	35	5.3	6	100	1.225	1.102	0.490	0.122	0.110	0.049
TPSD226*035#0125	D	22	35	7.7	6	125	1.095	0.986	0.438	0.137	0.123	0.055
TPSE226*035#0125	E	22	35	7.7	6	125	1.149	1.034	0.460	0.144	0.129	0.057
TPSD336*035#0200	D	33	35	11.6	6	200	0.866	0.779	0.346	0.173	0.156	0.069
TPSE336*035#0100	E	33	35	11.6	6	100	1.285	1.156	0.514	0.128	0.116	0.051
TPSD475*050#0300	D	4.7	50	2.4	6	300	0.707	0.636	0.283	0.212	0.191	0.085

All technical data relates to an ambient temperature of +25°C.
 Capacitance and DF are measured at 120Hz, 0.5V RMS with a maximum DC bias of 2.2 volts. DCL is measured at rated voltage after 5 minutes.
 * Insert K for ±10% and M for ±20% Capacitance Tolerance

Standard Plating – Insert R for 7" reel and S for 13" reel
 # **Gold Plating** – Insert A for 7" reel and B for 13" reel

NOTE: AVX reserves the right to supply a higher voltage rating or tighter tolerance part in the same case size, to the same reliability standards.



TPM Multianode

Tantalum Ultra Low ESR Capacitor

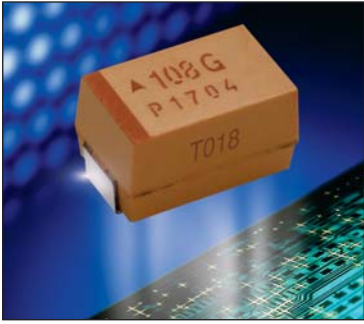

Low ESR, high capacitance and high ripple current are the key parameters for processor filtering. Multianode configuration within a standard E case package meets these requirements. Parameters such as ESR

15mΩ, capacitance 1500μF and ripple current above 4A rms makes TPM series ready to use with the latest processor families.

CASE DIMENSIONS: millimeters (inches)

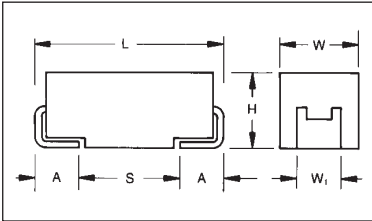

For part marking see page 164

Code	EIA Code	L±0.20 (0.008)	W+0.20 (0.008) -0.10 (0.004)	H+0.20 (0.008) -0.10 (0.004)	W ₁ ±0.20 (0.008)	A+0.30 (0.012) -0.20 (0.008)	S Min.
E	7343-43	7.30 (0.287)	4.30 (0.169)	4.10 (0.162)	2.40 (0.094)	1.30 (0.051)	4.40 (0.173)
V	7361-38	7.30 (0.287)	6.10 (0.240)	3.45 ±0.30 (0.136 ±0.012)	3.10 (0.120)	1.40 (0.055)	1.80 (0.071)

W₁ dimension applies to the termination width for A dimensional area only.

HOW TO ORDER

TPM
Type

E
Case Size
See table above

108
Capacitance Code
pF code: 1st two digits represent significant figures, 3rd digit represents multiplier (number of zeros to follow)

Capacitance Tolerance
K=±10%
M=±20%

004
Rated DC Voltage
002=2.5Vdc
004=4Vdc
006=6.3Vdc
010=10Vdc
016=16Vdc
020=20Vdc
025=25Vdc
035=35Vdc
050=50Vdc

R
Packaging
R = 7" T/R Lead Free
S = 13" T/R Lead Free
H = 7" Reel Tin Lead
K = 13" Reel Tin Lead

0018
Maximum ESR in Milliohms
See note below

NOTE: The EIA & CECC standards for low ESR Solid Tantalum Capacitors allow an ESR movement to 1.25 times catalog limit post mounting.

TECHNICAL SPECIFICATIONS

Technical Data:	All technical data relate to an ambient temperature of +25°C									
Capacitance Range:	10 μF to 1500 μF									
Capacitance Tolerance:	±10%, ±20%									
Rated Voltage (V _R)	≤ +85°C:	2.5	4	6.3	10	16	20	25	35	50
Category Voltage (V _C)	≤ +125°C:	1.7	2.7	4	7	10	13	17	23	33
Surge Voltage (V _S)	≤ +85°C:	3.3	5.2	8	13	20	26	32	46	65
Surge Voltage (V _S)	≤ +125°C:	2.2	3.4	5	8	13	16	20	28	40
Temperature Range:	-55°C to +125°C									
Reliability:	1% per 1000 hours at 85°C, V _R with 0.1Ω/V series impedance, 60% confidence level									



TPM Multianode



Tantalum Ultra Low ESR Capacitor

CAPACITANCE AND RATED VOLTAGE RANGE LETTER DENOTES CASE SIZE ESR LIMIT IN BRACKETS

Capacitance		Rated Voltage DC (V _R) to 85°C								
μF	Code	2.5V (e)	4V (G)	6.3V (J)	10V (A)	16V (C)	20V (D)	25V (E)	35V (V)	50V (T)
6.8	685									D(200)*
10	106									D(140)* E(120)
15	156									E(75,100)
22	226								D(65)* E(60,100)	E(75,100)
33	336							D(60)*	D(75)* E(50,65)	
47	476							D(55)*	E(55,65)	
68	686						D(50)*	E(45,55)	V	
100	107						E(35,45)	E		
150	157					D(45)* E(30,40)	E			
220	227				D(35)*	E(25,40)				
330	337				D(35)* E(23,35)	E				
470	477			D(30)* E(18,23,30)	E(23,30)					
680	687		E(18,23)	D(30)* E(18,23), V(23)	E					
1000	108	D(25)*	D(25)* E(18,23), V(18)	E						
1500	158	E(12,15,18)	E(15,18)							
2200	228	E(18)								

Developmental Ratings - subject to change, AVX reserve rights to change ESR specification prior to release.

Note: Voltage ratings are minimum values. AVX reserves the right to supply higher ratings in the same case size, to the same reliability standards.



TPM Multianode



Tantalum Ultra Low ESR Capacitor

RATINGS & PART NUMBER REFERENCE

AVX Part No.	Case Size	Capacitance (µF)	Rated Voltage (V)	DCL (µA) Max.	DF % Max.	ESR Max. (mΩ) @100kHz	100kHz Ripple Current Ratings (A)			100kHz Ripple Voltage Ratings (V)		
							25°C	85°C	125°C	25°C	85°C	125°C
2.5 Volt @ 85°C (1.7 Volt @ 125°C)												
TPME158*002#0012	E	1500	2.5	38	6	12	4.743	4.269	1.897	0.057	0.051	0.023
TPME158*002#0015	E	1500	2.5	38	6	15	4.243	3.818	1.697	0.064	0.057	0.025
TPME158*002#0018	E	1500	2.5	38	6	18	3.873	3.486	1.549	0.070	0.063	0.028
TPME228*002#0018	E	2200	2.5	44	10	18	3.873	3.486	1.549	0.070	0.063	0.028
4 Volt @ 85°C (2.7 Volt @ 125°C)												
TPME687*004#0018	E	680	4	27	6	18	3.873	3.486	1.549	0.070	0.063	0.028
TPME687*004#0023	E	680	4	27	6	23	3.426	3.084	1.370	0.079	0.071	0.032
TPME108*004#0018	E	1000	4	40	6	18	3.873	3.486	1.549	0.070	0.063	0.028
TPME108*004#0023	E	1000	4	40	6	23	3.426	3.084	1.370	0.079	0.071	0.032
TPMV108*004#0018	V	1000	4	40	6	18	3.979	3.581	1.592	0.072	0.064	0.029
TPME158*004#0015	E	1500	4	40	6	15	4.243	3.818	1.697	0.064	0.057	0.025
TPME158*004#0018	E	1500	4	40	6	18	3.873	3.486	1.549	0.070	0.063	0.028
6.3 Volt @ 85°C (4 Volt @ 125°C)												
TPME477*006#0018	E	470	6.3	28	6	18	3.873	3.486	1.549	0.070	0.063	0.028
TPME477*006#0023	E	470	6.3	28	6	23	3.426	3.084	1.370	0.079	0.071	0.032
TPME477*006#0030	E	470	6.3	28	6	30	3.000	2.700	1.200	0.090	0.081	0.036
TPME687*006#0018	E	680	6.3	41	6	18	3.873	3.486	1.549	0.070	0.063	0.028
TPME687*006#0023	E	680	6.3	41	6	23	3.426	3.084	1.370	0.079	0.071	0.032
TPMV687*006#0023	V	680	6.3	41	6	23	3.520	3.168	1.408	0.081	0.073	0.032
10 Volt @ 85°C (7 Volt @ 125°C)												
TPME337*010#0023	E	330	10	33	6	23	3.426	3.084	1.370	0.079	0.071	0.032
TPME337*010#0035	E	330	10	33	6	35	2.777	2.500	1.111	0.097	0.087	0.039
TPME477M010#0023	E	470	10	47	6	23	3.426	3.084	1.370	0.079	0.071	0.032
TPME477M010#0030	E	470	10	47	6	30	3.000	2.700	1.200	0.090	0.081	0.036
16 Volt @ 85°C (10 Volt @ 125°C)												
TPME157*016#0030	E	150	16	24	6	30	3.000	2.700	1.200	0.090	0.081	0.036
TPME157*016#0040	E	150	16	24	6	40	2.598	2.338	1.039	0.104	0.094	0.042
TPME227*016#0025	E	220	16	35	6	25	3.286	2.958	1.315	0.082	0.074	0.033
TPME227*016#0040	E	220	16	35	6	40	2.598	2.338	1.039	0.104	0.094	0.042
20 Volt @ 85°C (13 Volt @ 125°C)												
TPME107*020#0035	E	100	20	20	6	35	2.777	2.500	1.111	0.097	0.087	0.039
TPME107*020#0045	E	100	20	20	6	45	2.449	2.205	0.980	0.110	0.099	0.044
25 Volt @ 85°C (17 Volt @ 125°C)												
TPME686*025#0045	E	68	25	17	6	45	2.449	2.205	0.980	0.110	0.099	0.044
TPME686*025#0055	E	68	25	17	6	55	2.216	1.994	0.886	0.122	0.110	0.049
35 Volt @ 85°C (23 Volt @ 125°C)												
TPME226*035#0060	E	22	35	8	6	60	2.121	1.909	0.849	0.127	0.115	0.051
TPME226*035#0100	E	22	35	8	6	100	1.643	1.479	0.657	0.164	0.148	0.066
TPME336*035#0050	E	33	35	12	6	50	2.324	2.091	0.930	0.116	0.105	0.046
TPME336*035#0065	E	33	35	12	6	65	2.038	1.834	0.815	0.132	0.119	0.053
TPME476*035#0055	E	47	35	16	6	55	2.216	1.994	0.886	0.122	0.110	0.049
TPME476*035#0065	E	47	35	16	6	65	2.038	1.834	0.815	0.132	0.119	0.053
50 Volt @ 85°C (33 Volt @ 125°C)												
TPME106*050#0120	E	10	50	5	6	120	1.500	1.350	0.600	0.180	0.162	0.072
TPME156*050#0075	E	15	50	7.5	6	75	1.897	1.708	0.759	0.142	0.128	0.057
TPME156*050#0100	E	15	50	7.5	6	100	1.643	1.479	0.657	0.164	0.148	0.066
TPME226*050#0075	E	22	50	11	8	75	1.897	1.708	0.759	0.142	0.128	0.057
TPME226*050#0100	E	22	50	11	8	100	1.643	1.479	0.657	0.164	0.148	0.066

All technical data relates to an ambient temperature of +25°C.
 Capacitance and DF are measured at 120Hz,
 0.5V RMS with maximum DC bias of 2.2 volts.
 DCL is measured at rated voltage after 5 minutes.

* Insert K for ±10% and M for ±20% Capacitance Tolerance

TPM MULTIANODE CONSTRUCTION

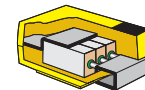

TCJ Series



Tantalum Solid Electrolytic Chip Capacitors with Conductive Polymer Electrode

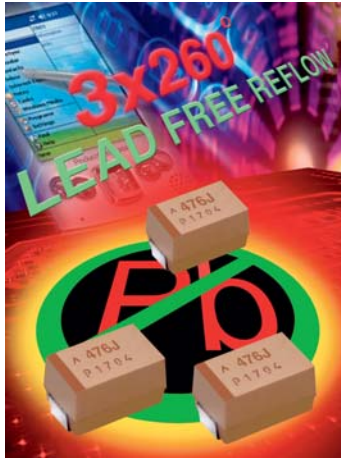

The TCJ Series of tantalum capacitors with a conductive polymer electrode offers lower ESR, safer non-ignition failure mode and better capacitance retention compared to the conventional MnO₂ electrode capacitors. The TCJ series is suitable for power management systems with operating temperatures up to 125°C. In addition the TCJ series complies with RoHS requirements and it is an environmentally friendly component ready for lead-free assembly systems up to 3x reflow with 260°C peak temperature. Small A and B case sizes are ideal for use with the latest portable handheld electronics such as cellular phones, PDAs or other digital equipment such as cameras.



LEAD-FREE
LEAD-FREE COMPATIBLE COMPONENT



HALOGEN-FREE COMPOUNDS
ENVIRONMENTAL FRIENDLY COMPONENT

CASE DIMENSIONS: millimeters (inches)

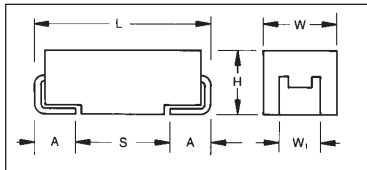

For part marking see page 164

Code	EIA Code	L±0.20 (0.008)	W+0.20 (0.008) -0.10 (0.004)	H+0.20 (0.008) -0.10 (0.004)	W ₁ ±0.20 (0.008)	A+0.30 (0.012) -0.20 (0.008)	S Min.
A	3216-18	3.20 (0.126)	1.60 (0.063)	1.60 (0.063)	1.20 (0.047)	0.80 (0.031)	1.80 (0.071)
B	3528-21	3.50 (0.138)	2.80 (0.110)	1.90 (0.075)	2.20 (0.087)	0.80 (0.031)	1.40 (0.055)
H	3528-12	3.50 (0.138)	2.80 (0.110)	1.50 (0.059)	2.20 (0.087)	0.80 (0.031)	1.40 (0.055)
R	2012-12	2.05 (0.081)	1.30 (0.051)	1.20 (0.047) max	1.0±0.1 (0.039±0.004)	0.50 (0.020)	0.85 (0.033)
T	3528-12	3.50 (0.138)	2.80 (0.110)	1.20 (0.047) max	2.20 (0.087)	0.80 (0.031)	2.00 (0.079)
W	6032-15	6.00 (0.236)	3.20 (0.126)	1.50 (0.059) max	2.20 (0.087)	1.30 (0.051)	2.90 (0.114)
Y	7343-20	7.30 (0.287)	4.30 (0.169)	2.00 (0.079) max	2.40 (0.094)	1.30 (0.051)	4.40 (0.173)

W₁ dimension applies to the termination width for A dimensional area only.

HOW TO ORDER

TCJ

Type

A

Case Size
See table above

226

Capacitance Code
pF code: 1st two digits represent significant figures, 3rd digit represents multiplier (number of zeros to follow)

M

Tolerance
M=±20%

004

Rated DC Voltage
002=2.5Vdc
004=4Vdc
006=6.3Vdc
010=10Vdc
016=16Vdc

R

Packaging
R=7" T/R
S=13" T/R

0300

ESR in mΩ

TECHNICAL SPECIFICATIONS

Technical Data: All technical data relate to an ambient temperature of +25°C

Capacitance Range: 4.7 μF to 150 μF

Capacitance Tolerance: ±20%

Leakage Current DCL: 0.1CV

Rated Voltage (V _R)	≤ +85°C:	2.5	4	6.3	10	16
Category Voltage (V _C)	≤ +125°C:	1.7	2.7	4	7	10
Surge Voltage (V _S)	≤ +85°C:	3.3	5.2	8	13	20
Surge Voltage (V _S)	≤ +125°C:	2.0	3.4	5.0	8	13

Temperature Range: -55°C to +125°C

Reliability: 1% per 1000 hours at 85°C, V_R with 0.1Ω/V_R series impedance, 60% confidence level



TCJ Series



Tantalum Solid Electrolytic Chip Capacitors with Conductive Polymer Electrode

CAPACITANCE AND RATED VOLTAGE, V_R (VOLTAGE CODE) RANGE (LETTER DENOTES CASE SIZE)

Capacitance		Rated Voltage DC (V_R) to 85°C				
μF	Code	2.5V (e)	4V (G)	6.3V (J)	10V (A)	16V (C)
4.7	475				R (500)	
6.8	685					A (200)
10	106			A (300), R (500)	A (300)	A (200), T (150)
15	156		A (300)	A (300)	A (200)	B (150)
22	226		A (300)	A (300), T (150)	B (300), T (150)	B (150)
33	336		A (300)	A (200), B (70,200), T (150)	C (100), B (70,200), T (150), T (70)	B (300)
47	476		A (200), T (80)	A (200), T (80), B (70)	B (70), C (100)	
68	686	A (250)	A (250), B (70), T (80)	B (55), C (100)		
100	107	A (200), B (70)	A (200), B (70), T (150)	B (45,70)		
150	157	B (70)	B (70), W (70)	H (150)*, W (40,70), Y (25)		
220	227	B (70)	Y (25)	Y (25)		

Developmental Ratings - subject to change.

Violet - Please Contact Manufacturer

Available Ratings, (ESR ratings in mOhms in brackets)

The EIA and CECC standards for low ESR solid Tantalum capacitors allow an ESR movement to 1.25 times catalog limit post mounting.



TCJ Series



Tantalum Solid Electrolytic Chip Capacitors with Conductive Polymer Electrode

RATINGS & PART NUMBER REFERENCE

AVX Part No.	Case Size	Capacitance (µF)	Rated Voltage (V)	DCL (µA) Max.	DF % Max.	ESR Max. (mΩ) @100kHz	100kHz RMS Current (mA)			100kHz RMS Voltage (mV)		
							25°C	85°C	125°C	25°C	85°C	125°C
2 Volt @ 85°C (1.7 Volt @ 125°C)												
TCJA686M002#0250	A	68	2.5	17.0	6	250	548	493	219	137	123	55
TCJA107M002#0200	A	100	2.5	25.0	6	200	612	551	245	122	110	49
TCJB107M002#0070	B	100	2.5	25.0	6	70	1102	992	441	77	69	31
TCJB157M002#0070	B	150	2.5	37.5	6	70	1102	992	441	77	69	31
4 Volt @ 85°C (2.7 Volt @ 125°C)												
TCJA156M004#0300	A	15	4	6.0	6	300	500	450	200	150	135	60
TCJA226M004#0300	A	22	4	8.8	6	300	500	450	200	150	135	60
TCJA336M004#0300	A	33	4	13.2	6	300	500	450	200	150	135	60
TCJA476M004#0200	A	47	4	18.8	6	200	612	551	245	122	110	49
TCJT476M004#0080	T	47	4	18.8	8	80	1000	900	400	80	72	32
TCJA686M004#0250	A	68	4	27.2	6	250	548	493	219	137	123	55
TCJB686M004#0070	B	68	4	27.2	6	70	1102	992	441	77	69	31
TCJT686M004#0080	T	68	4	27.2	8	80	1000	900	400	80	72	32
TCJA107M004#0200	A	100	4	40.0	6	200	612	551	245	122	110	49
TCJB107M004#0070	B	100	4	40.0	8	70	1102	992	441	77	69	31
TCJT107M004#0150	T	100	4	40.0	8	150	730	657	292	110	99	44
TCJB157M004#0070	B	150	4	60.0	6	70	1102	992	441	77	69	31
6.3 Volt @ 85°C (4 Volt @ 125°C)												
TCJA106M006#0300	A	10	6.3	6.0	6	300	500	450	200	150	135	60
TCJR106M006#0500	R	10	6.3	6.0	6	500	332	298	133	166	149	66
TCJA156M006#0300	A	15	6.3	9.0	6	300	500	450	200	150	135	60
TCJA226M006#0300	A	22	6.3	13.2	6	300	500	450	200	150	135	60
TCJT226M006#0150	T	22	6.3	13.2	6	150	730	657	292	110	99	44
TCJA336M006#0200	A	33	6.3	19.8	6	200	612	551	245	122	110	49
TCJB336M006#0070	B	33	6.3	19.8	6	70	1102	992	441	77	69	31
TCJB336M006#0200	B	33	6.3	19.8	6	200	652	587	261	130	117	52
TCJT336M006#0150	T	33	6.3	19.8	8	150	730	657	292	110	99	44
TCJA476M006#0200	A	47	6.3	28.2	6	200	612	551	245	122	110	49
TCJB476M006#0070	B	47	6.3	28.2	6	70	1102	992	441	77	69	31
TCJT476M006#0080	T	47	6.3	28.2	8	80	1000	900	400	80	72	32
TCJB686M006#0055	B	68	6.3	40.8	8	55	1102	992	441	77	69	31
TCJC686M006#0100	C	68	6.3	40.8	6	100	1049	944	420	105	94	42
TCJB107M006#0045	B	100	6.3	60.0	10	45	1374	1237	550	62	56	25
TCJB107M006#0070	B	100	6.3	60.0	10	70	1102	992	441	77	69	31
TCJW157M006#0040	W	150	6.3	90.0	6	40	1500	1350	600	60	54	24
TCJW157M006#0070	W	150	6.3	90.0	6	70	1134	1021	454	79	71	32
10 Volt @ 85°C (7 Volt @ 125°C)												
TCJR475M010#0500	R	4.7	10	4.7	6	500	332	298	133	166	149	66
TCJA106M010#0300	A	10	10	10.0	6	300	500	450	200	150	135	60
TCJA156M010#0200	A	15	10	15.0	6	200	612	551	245	122	110	49
TCJB226M010#0300	B	22	10	22.0	6	300	532	479	213	160	144	64
TCJT226M010#0150	T	22	10	22.0	6	150	730	657	292	110	99	44
TCJB336M010#0070	B	33	10	33.0	6	70	1102	992	441	77	69	31
TCJB336M010#0200	B	33	10	33.0	6	200	652	587	261	130	117	52
TCJC336M010#0100	C	33	10	33.0	6	100	1049	944	420	105	94	42
TCJT336M010#0070	T	33	10	33.0	6	70	1069	962	428	75	67	30
TCJT336M010#0150	T	33	10	33.0	6	150	730	657	292	110	99	44
TCJB476M010#0070	B	47	10	47.0	6	70	1102	992	441	77	69	31
TCJC476M010#0100	C	47	10	47.0	6	100	1049	944	420	105	94	42
16 Volt @ 85°C (10 Volt @ 125°C)												
TCJA685M016#0200	A	6.8	16	10.9	6	200	612	551	245	122	110	49
TCJA106M016#0200	A	10	16	16.0	6	200	612	551	245	122	110	49
TCJT106M016#0150	T	10	16	16.0	6	150	730	657	292	110	99	44
TCJB156M016#0150	B	15	16	24.0	6	150	753	677	301	113	102	45
TCJB226M016#0150	B	22	16	35.2	6	150	753	677	301	113	102	45

insert R for 7" reel or S for 13" reel

All technical data relates to an ambient temperature of +25°C. Capacitance and DF are measured at 120Hz, 0.5 RMS with DC bias of 2.2 volts. DCL is measured at rated voltage after 5 minutes. TCJ series is MSL level 3 according to J-STD-020C.

NOTE: AVX reserves the right to supply a higher voltage rating in the same case size, to the same reliability standards.

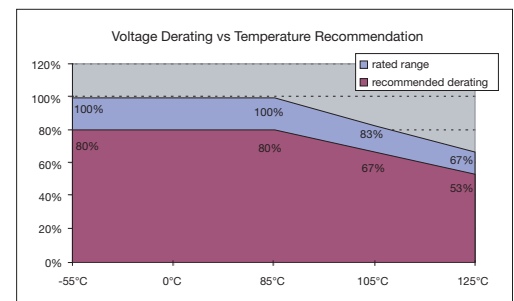

TRJ Series



Professional Tantalum Chip Capacitor



The TRJ surface mount series employs established Tantalum technology together with new process improvements and advanced manufacturing techniques. This robust series enables extension of the guaranteed 0.5% reliability level to 1000 hours at rated voltage, rated temperature and 0.1Ω/volt circuit impedance. The moisture penetration barrier, thicker external dielectric layer and modified manganising process make the capacitor more robust against higher thermo-mechanical stresses during assembly process (“lead-free”

soldering) and also more robust against more severe working conditions in Automotive, Medical, Aerospace, Military and other applications. The temperature range is -55°C to 125°C and voltage range is 6.3V to 50V.

These components do not contain any lead either in the internal structure or in the termination plating. They are compatible with all SnPb and “lead-free” solders and are qualified for higher reflow temperature necessary for new lead-free assembly process.

CASE DIMENSIONS: millimeters (inches)

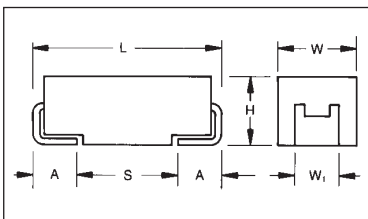

For part marking see page 164

Code	EIA Code	L±0.20 (0.008)	W+0.20 (0.008) -0.10 (0.004)	H+0.20 (0.008) -0.10 (0.004)	W ₁ ±0.20 (0.008)	A+0.30 (0.012) -0.20 (0.008)	S Min.
A	3216-18	3.20 (0.126)	1.60 (0.063)	1.60 (0.063)	1.20 (0.047)	0.80 (0.031)	1.80 (0.071)
B	3528-21	3.50 (0.138)	2.80 (0.110)	1.90 (0.075)	2.20 (0.087)	0.80 (0.031)	1.40 (0.055)
C	6032-28	6.00 (0.236)	3.20 (0.126)	2.60 (0.102)	2.20 (0.087)	1.30 (0.051)	2.90 (0.114)
D	7343-31	7.30 (0.287)	4.30 (0.169)	2.90 (0.114)	2.40 (0.094)	1.30 (0.051)	4.40 (0.173)
E	7343-43	7.30 (0.287)	4.30 (0.169)	4.10 (0.162)	2.40 (0.094)	1.30 (0.051)	4.40 (0.173)

W₁ dimension applies to the termination width for A dimensional area only.

HOW TO ORDER

TRJ

Type

B

Case Size
See table above

105

Capacitor Code
pF code: 1st two digits represent significant figures, 3rd digit represents multiplier (number of zeros to follow)

Tolerance
K=±10%
M=±20%

035

Rated DC Voltage
006 = 6.3V
010 = 10V
016 = 16V
020 = 20V
025 = 25V
035 = 35V
050 = 50V

R

Packaging/
Termination Plating
R = 7" T/R Lead Free
S = 13" T/R Lead Free
A = Gold Plating 7" Reel
B = Gold Plating 13" Reel
H = Tin Lead 7" Reel
K = Tin Lead 13" Reel

RJ

Additional characters may be added for special requirements

TECHNICAL SPECIFICATIONS

Technical Data:	All technical data relate to an ambient temperature of +25°C							
Capacitance Range:	0.1 μF to 470 μF							
Capacitance Tolerance:	±10%; ±20%							
Leakage Current DCL:	0.0075CV							
Rated Voltage (V _R)	≤ +85°C:	6.3	10	16	20	25	35	50
Category Voltage (V _C)	≤ +125°C:	4	7	10	13	17	23	33
Surge Voltage (V _S)	≤ +85°C:	8	13	20	26	32	46	65
Surge Voltage (V _S)	≤ +125°C:	5	8	13	16	20	28	40
Temperature Range:	-55°C to +125°C							
Reliability:	0.5% per 1000 hours at 85°C, V _R with 0.1Ω/V series impedance, 60% confidence level							
Termination Plating:	Sn Plating (standard), Gold and SnPb Plating upon request Meets requirements of AEC-Q200							



TRJ Series



Professional Tantalum Chip Capacitor

CAPACITANCE AND RATED VOLTAGE, V_R (VOLTAGE CODE) RANGE LETTER DENOTES CASE SIZE

Capacitance		Rated Voltage DC (V_R) to 85°C						
μF	Code	6.3V (J)	10V (A)	16V (C)	20V (D)	25V (E)	35V (V)	50V (T)
0.10	104						A	
0.15	154						A	
0.22	224						A	A
0.33	334						A	A
0.47	474					A	A	B
0.68	684					A	A	B
1.0	105				A	A	A/B	B
1.5	155				A	A	A/B	C
2.2	225			A	A	A/B	B	C
3.3	335			A	A/B	B	B/C	C/D
4.7	475		A	A/B	A/B	B	B/C	D
6.8	685		A	A/B	B	B/C	C	D
10	106	A	A/B	B	B/C	C	C/D	E
15	156	A/B	A/B	B	B/C	C/D	C/D	
22	226	A/B	B	B/C	C/D	C/D	D	
33	336	B	B/C	C	C/D	D	D/E	
47	476	B/C	C	C/D	D	D/E		
68	686	C	C	D	D/E			
100	107	C	C/D	D/E	D/E			
150	157	C/D	D/E	E				
220	227	D	D/E					
330	337	E	E					
470	477	E						

Note: Voltage ratings are minimum values. AVX reserves the right to supply higher ratings in the same reliability standards.

Developmental Ratings - subject to change

HOW TO ORDER – FOR COTS-Plus PRODUCTS

TRJ

Type

B

Case Size

105

Capacitance Code
pF code: 1st two digits represent significant figures
3rd digit represents multiplier (number of zeros to follow)

M

Tolerance
K=±10%
M=±20%

035

Rated DC Voltage
006=6.3Vdc
010=10Vdc
016=16Vdc
020=20Vdc
025=25Vdc
035=35Vdc

E

Packaging/
Termination Plating
E = non modular quantity tin/lead termination finish

C000

Additional characters may be added for special requirements (see below)

Suffix details

First digit

C = for COTS-Plus

Second digit

0 (zero) = for no surge requirement
S = for 10 cycles, 25°C surge
T = for 10 cycles, -55 and 85°C surge

Third digit

0 (zero) = standard ESR
L = for low ESR

Fourth digit

0 (zero) = standard M/L level reliability
B = for Weibull grade "B"
C = for Weibull grade "C"
Z = for non ER



TRJ Series



Professional Tantalum Chip Capacitor

RATINGS & PART NUMBER REFERENCE

AVX Part No.	Case Size	Capacitance (μF)	DCL (μA) Max.	DF % Max.	ESR Max. (Ω) @ 100 kHz
Voltage Rating 6.3 v @ 85°C (4 v @ 125°C)					
TRJA106*006#	A	10	0.45	6	2.2
TRJA156*006#	A	15	0.68	6	2.0
TRJB156*006#	B	15	0.68	6	2.0
TRJA226*006#	A	22	0.99	6	1.7
TRJB226*006#	B	22	0.99	6	1.9
TRJB336*006#	B	33	1.5	6	1.7
TRJB476*006#	B	47	2.1	6	1.6
TRJC476*006#	C	47	2.1	6	0.5
TRJC686*006#	C	68	3.1	6	0.5
TRJC107*006#	C	100	4.5	6	0.4
TRJC157*006#	C	150	6.8	8	0.5
TRJD157*006#	D	150	6.8	6	0.4
TRJD227*006#	D	220	9.9	8	0.4
TRJE337*006#	E	330	14	8	0.3
TRJE477*006#	E	470	20.8	8	0.2
Voltage Rating 10 v @ 85°C (7 v @ 125°C)					
TRJA475*010#	A	4.7	0.35	6	3.2
TRJA685*010#	A	6.8	0.51	6	2.6
TRJA106*010#	A	10	0.75	6	2.2
TRJB106*010#	B	10	0.75	6	2.2
TRJA156*010#	A	15	1.1	6	1.8
TRJB156*010#	B	15	1.1	6	2.0
TRJB226*010#	B	22	1.7	6	1.9
TRJB336*010#	B	33	2.5	6	1.0
TRJC336*010#	C	33	2.5	6	0.6
TRJC476*010#	C	47	3.5	6	0.5
TRJC686*010#	C	68	5.1	6	0.5
TRJC107*010#	C	100	7.5	8	0.5
TRJD107*010#	D	100	7.5	6	0.4
TRJD157*010#	D	150	11	8	0.4
TRJE157*010#	E	150	11	8	0.4
TRJE227*010#	E	220	17	8	0.4
TRJE337*010#	E	330	24.8	8	0.3
Voltage Rating 16 v @ 85°C (10 v @ 125°C)					
TRJA225*016#	A	2.2	0.30	6	4.5
TRJA335*016#	A	3.3	0.40	6	3.7
TRJA475*016#	A	4.7	0.56	6	3.2
TRJB475*016#	B	4.7	0.56	6	3.2
TRJA685*016#	A	6.8	0.82	4	2.0
TRJB685*016#	B	6.8	0.82	6	2.6
TRJB106*016#	B	10	1.2	6	2.2
TRJB156*016#	B	15	1.8	6	2.0
TRJB226*016#	B	22	2.6	6	1.1
TRJC226*016#	C	22	2.6	6	0.7
TRJC336*016#	C	33	4.0	6	0.6
TRJC476*016#	C	47	5.6	6	0.5
TRJD476*016#	D	47	5.6	6	0.5
TRJD686*016#	D	68	8.2	6	0.5
TRJD107*016#	D	100	12	6	0.4
TRJE107*016#	E	100	12	6	0.4
TRJE157*016#	E	150	16	6	0.3

AVX Part No.	Case Size	Capacitance (μF)	DCL (μA) Max.	DF % Max.	ESR Max. (Ω) @ 100 kHz
Voltage Rating 20 v @ 85°C (13 v @ 125°C)					
TRJA105*020#	A	1	0.30	4	6.6
TRJA155*020#	A	1.5	0.30	6	5.5
TRJA225*020#	A	2.2	0.33	6	4.5
TRJA335*020#	A	3.3	0.50	6	3.7
TRJB335*020#	B	3.3	0.50	6	3.7
TRJA475*020#	A	4.7	0.71	5	2.5
TRJB475*020#	B	4.7	0.71	6	3.2
TRJB685*020#	B	6.8	1.0	6	2.6
TRJB106*020#	B	10	1.5	6	2.2
TRJC106*020#	C	10	1.5	6	0.8
TRJB156*020#	B	15	2.3	6	1.4
TRJC156*020#	C	15	2.3	6	0.7
TRJC226*020#	C	22	3.3	6	0.7
TRJD226*020#	D	22	3.3	6	0.7
TRJC336*020#	C	33	5.0	6	0.6
TRJD336*020#	D	33	5.0	6	0.6
TRJD476*020#	D	47	7.1	6	0.5
TRJD686*020#	D	68	10	6	0.5
TRJE686*020#	E	68	10	6	0.5
TRJE107*020#	E	100	15	6	0.3
Voltage Rating 25 v @ 85°C (17 v @ 125°C)					
TRJA474*025#	A	0.47	0.30	4	9.5
TRJA684*025#	A	0.68	0.30	4	8.0
TRJA105*025#	A	1	0.30	4	6.6
TRJA155*025#	A	1.5	0.30	6	5.5
TRJA225*025#	A	2.2	0.41	6	2.9
TRJB225*025#	B	2.2	0.41	6	4.5
TRJB335*025#	B	3.3	0.62	6	3.7
TRJB475*025#	B	4.7	0.88	6	3.2
TRJB685*025#	B	6.8	1.3	6	1.5
TRJC685*025#	C	6.8	1.3	6	1.1
TRJC106*025#	C	10	1.9	6	0.8
TRJC156*025#	C	15	2.8	6	0.7
TRJD156*025#	D	15	2.8	6	0.7
TRJD226*025#	D	22	4.1	6	0.7
TRJD336*025#	D	33	6.2	6	0.6
TRJE476*025#	E	47	8.8	6	0.5
Voltage Rating 35 v @ 85°C (23 v @ 125°C)					
TRJA104*035#	A	0.1	0.30	4	20
TRJA154*035#	A	0.15	0.30	4	16
TRJA224*035#	A	0.22	0.30	4	14
TRJA334*035#	A	0.33	0.30	4	11
TRJA474*035#	A	0.47	0.30	4	9.5
TRJA684*035#	A	0.68	0.30	4	8.0
TRJA105*035#	A	1	0.30	4	6.6
TRJB105*035#	B	1	0.30	4	3.4
TRJA155*035#	A	1.5	0.39	6	3.1
TRJB155*035#	B	1.5	0.39	6	5.5
TRJB225*035#	B	2.2	0.58	6	4.5
TRJB335*035#	B	3.3	0.87	6	3.7
TRJC335*035#	C	3.3	0.87	6	1.8
TRJB475*035#	B	4.7	1.2	6	2.2
TRJC475*035#	C	4.7	1.2	6	1.4
TRJC685*035#	C	6.8	1.8	6	1.1
TRJC106*035#	C	10	2.6	6	0.8
TRJD106*035#	D	10	2.6	6	0.8
TRJD156*035#	D	15	3.9	6	0.7
TRJD226*035#	D	22	5.8	6	0.7
TRJE336*035#	E	33	8.7	6	0.6
Voltage Rating 50 v @ 85°C (33 v @ 125°C)					
TRJA224*050#	A	0.22	0.30	4	7.5
TRJA334*050#	A	0.33	0.30	4	7.0
TRJB474*050#	B	0.47	0.30	4	5.0
TRJB684*050#	B	0.68	0.30	4	4.0
TRJB105*050#	B	1.0	0.40	4	3.4
TRJC155*050#	C	1.5	0.60	6	2.5
TRJC225*050#	C	2.2	0.80	6	1.7
TRJC335*050#	C	3.3	1.20	6	1.4
TRJD335*050#	D	3.3	1.20	4.5	1.1
TRJD475*050#	D	4.7	1.80	4.5	0.9
TRJD685*050#	D	6.8	2.60	4.5	0.7
TRJE106*050#	E	10	3.80	4.5	0.7

All technical data relates to an ambient temperature of +25°C. Capacitance and DF are measured at 120Hz, 0.5V RMS with a maximum DC bias of 2.2 volts. DCL is measured at rated voltage after 5 minutes.

* Insert K for ±10% and M for ±20%

Termination finished and packaging reel size

NOTE: AVX reserves the right to supply higher specification parts in the same case size, to the same reliability standards.



THJ Series



High Temperature Tantalum Chip Capacitor

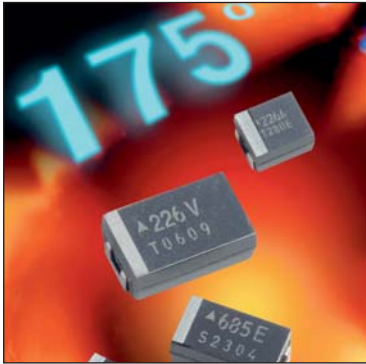

The THJ surface mount series combines high temperature operation and higher basic reliability for optimal performance in high temperature automotive and industry applications. The operational temperature is up to +175°C with derating voltage. The level of reliability of this tantalum product is 0.5% / 1000

hours at rated voltage, rated temperature and 0.1Ω/volt circuit impedance. The capacitors are produced in black encapsulation with white polarity marking. The THJ series encompasses the 4 case sizes with dimensions identical to TAJ standard series. The voltage range available today is 6.3V to 50V.

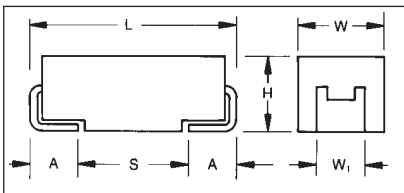

For part marking see page 164

CASE DIMENSIONS: millimeters (inches)

Code	EIA Code	L±0.20 (0.008)	W+0.20 (0.008) -0.10 (0.004)	H±0.20 (0.008) -0.10 (0.004)	W ₁ ±0.20 (0.008)	A+0.30 (0.012) -0.20 (0.008)	S Min.
A	3216-18	3.20 (0.126)	1.60 (0.063)	1.60 (0.063)	1.20 (0.047)	0.80 (0.031)	1.80 (0.071)
B	3528-21	3.50 (0.138)	2.80 (0.110)	1.90 (0.075)	2.20 (0.087)	0.80 (0.031)	1.40 (0.055)
C	6032-28	6.00 (0.236)	3.20 (0.126)	2.60 (0.102)	2.20 (0.087)	1.30 (0.051)	2.90 (0.114)
D	7343-31	7.30 (0.287)	4.30 (0.169)	2.90 (0.114)	2.40 (0.094)	1.30 (0.051)	4.40 (0.173)

W₁ dimension applies to the termination width for A dimensional area only.

HOW TO ORDER

THJ

Type

B

Case Size
See table above

105

Capacitance Code
pF code: 1st two digits represent significant figures
3rd digit represents multiplier (number of zeros to follow)

Tolerance
K=±10%
M=±20%

035

Rated DC Voltage
006=6.3Vdc
010=10Vdc
016=16Vdc
020=20Vdc
025=25Vdc
035=35Vdc
050=50Vdc

R

Packaging
R = 7" T/R Lead Free
S = 13" T/R Lead Free
A = Gold Plating 7" Reel
B = Gold Plating 13" Reel
H = Tin Lead 7" Reel
K = Tin Lead 13" Reel

JN

Additional characters may be added for special requirements

TECHNICAL SPECIFICATIONS

Technical Data:	All technical data relate to an ambient temperature of +25°C							
Capacitance Range:	0.1 μF to 150 μF							
Capacitance Tolerance:	±10%; ±20%							
Rated Voltage (V _R)	≤ +85°C:	6.3	10	16	20	25	35	50
Category Voltage (V _C)	≤ +125°C	4	7	10	13	17	23	33
	≤ +175°C	3	5	8	10	12	17	25
Surge Voltage (V _S)	≤ +85°C	8	13	20	26	32	46	65
	≤ +125°C	5	8	13	16	20	28	40
	≤ +175°C	4	6	10	12	15	21	30
Temperature Range:	Up to 175°C with 50% derating.							
Reliability:	0.5% per 1000 hours at 85°C, V _R with 0.1Ω/V series impedance, 60% confidence level, 3.5 Fits at 40°C, 0.5V _R							
Termination Finish:	Sn Plating (standard), Gold Plating available on request							
	Meets requirements of AEC-Q200							



THJ Series



High Temperature Tantalum Chip Capacitor

CAPACITANCE AND VOLTAGE RANGE (LETTER DENOTES CASE SIZE)

Capacitance		Rated voltage (V _R) to 85°C (Voltage Code)						
μF	Code	6.3V (J)	10V (A)	16V (C)	20V (D)	25V (E)	35V (V)	50V (T)
0.10	104						A	
0.15	154						A	
0.22	224						A	
0.33	334						A	
0.47	474					A	B	
0.68	684					A	B	
1.0	105				A	A	A/B	
1.5	155			A			C	
2.2	225			A		B	C	
3.3	335		A	A	B		C	
4.7	475	A	A	A/B			C	D
6.8	685	A	A	A/B		C	D	
10	106	A	B	B		C	D	
15	156	B	B	B	C		D	
22	226	B	B	C		D	D	
33	336	B	C	C	D	D	E	
47	476	C	C	D				
68	686	C	D	D				
100	107	D	D					
150	157	D						
220	227							
330	337							
470	477							
680	687							
1000	108							



THJ Series



High Temperature Tantalum Chip Capacitor

RATINGS & PART NUMBER REFERENCE

AVX Part No.	Case Size	Capacitance (μF)	Rated Voltage (V)	DCL (μA) Max.	DF % Max.	ESR Max. (Ω) @ 100 kHz
Voltage Rating 6.3 v @ 85°C (3 v @ 175°C) / J						
THJA475*006#JN	A	4.7	6.3	0.5	6	6
THJA685*006#JN	A	6.8	6.3	0.5	4.5	2.6
THJA106*006#JN	A	10	6.3	0.6	4.5	2.2
THJB156*006#JN	B	15	6.3	0.9	6	2.5
THJB226*006#JN	B	22	6.3	1.4	6	2.5
THJB336*006#JN	B	33	6.3	1.9	6	1.7
THJC476*006#JN	C	47	6.3	3.0	6	1.6
THJC686*006#JN	C	68	6.3	4.3	6	1.5
THJD107*006#JN	D	100	6.3	6	4.5	0.4
THJD157*006#JN	D	150	6.3	9.5	6	0.9
Voltage Rating 10 v @ 85°C (5 v @ 175°C) / A						
THJA335*010#JN	A	3.3	10	0.5	6	5.5
THJA475*010#JN	A	4.7	10	0.5	4.5	2.9
THJA685*010#JN	A	6.8	10	0.7	4.5	2.6
THJB106*010#JN	B	10	10	1	4.5	1.8
THJB156*010#JN	B	15	10	1.5	4.5	1.5
THJB226*010#JN	B	22	10	2.2	6	1.9
THJC336*010#JN	C	33	10	3.3	6	1.6
THJC476*010#JN	C	47	10	4.7	4.5	0.5
THJD686*010#JN	D	68	10	6.8	4.5	0.4
THJD107*010#JN	D	100	10	10	6	0.9
Voltage Rating 16 v @ 85°C (8 v @ 175°C) / C						
THJA225*016#JN	A	2.2	16	0.5	6	6.5
THJA335*016#JN	A	3.3	16	0.5	6	3.7
THJA475*016#JN	A	4.7	16	0.8	4.5	2.9
THJB475*016#JN	B	4.7	16	0.8	6	3.5
THJA685*016#JN	A	6.8	16	1.1	6	2.6
THJB685*016#JN	B	6.8	16	1.1	6	2.5
THJB106*016#JN	B	10	16	1.6	6	2.8
THJB156*016#JN	B	15	16	2.4	6	2.0
THJC226*016#JN	C	22	16	3.5	6	1.6
THJC336*016#JN	C	33	16	5.3	6	0.6
THJD476*016#JN	D	47	16	7.5	6	0.9
THJD686*016#JN	D	68	16	10.9	6	0.9

AVX Part No.	Case Size	Capacitance (μF)	Rated Voltage (V)	DCL (μA) Max.	DF % Max.	ESR Max. (Ω) @ 100 kHz
Voltage Rating 20 v @ 85°C (10 v @ 175°C) / D						
THJA155*020#JN	A	1.5	20	0.5	6	6.5
THJB335*020#JN	B	3.3	20	0.7	6	3
THJC156*020#JN	C	15	20	3.0	6	1.7
THJD336*020#JN	D	33	20	6.6	6	0.9
Voltage Rating 25 v @ 85°C (12 v @ 175°C) / E						
THJA474*025#R	A	0.47	25	0.5	4	14
THJA684*025#JN	A	0.68	25	0.5	4	10
THJA105*025#JN	A	1.0	25	0.5	3	5.2
THJB225*025#JN	B	2.2	25	0.6	6	4.5
THJC685*025#JN	C	6.8	25	1.7	6	2
THJC106*025#JN	C	10	25	2.5	6	1.8
THJD225*025#JN	D	22	25	5.5	6	0.9
THJD336*025#JN	D	33	25	8.3	6	0.5
Voltage Rating 35 v @ 85°C (17 v @ 175°C) / V						
THJA104*035#JN	A	0.1	35	0.5	4	24
THJA154*035#JN	A	0.15	35	0.5	4	21
THJA224*035#JN	A	0.22	35	0.5	4	18
THJA334*035#JN	A	0.33	35	0.5	4	15
THJB474*035#R	B	0.47	35	0.5	4	10
THJB684*035#JN	B	0.68	35	0.5	4	8
THJA105*035#JN	A	1.0	35	0.5	4	6.6
THJB105*035#JN	B	1.0	35	0.5	4	6.5
THJC155*035#JN	C	1.5	35	0.5	6	4.5
THJC225*035#JN	C	2.2	35	0.8	6	3.5
THJC335*035#JN	C	3.3	35	1.2	6	2.5
THJC475*035#JN	C	4.7	35	1.6	6	2.2
THJD685*035#JN	D	6.8	35	2.4	6	1.3
THJD106*035#JN	D	10	35	3.5	6	1
THJD156*035#JN	D	15	35	5.3	6	0.9
THJD226*035#JN	D	22	35	7.7	6	0.9
THJE336*035#JN	E	33	35	11.6	6	0.5
Voltage Rating 50 v @ 85°C (25 v @ 150°C) / T						
THJD475*050#JN	D	4.7	50	2.4	6	0.9

All technical data relates to an ambient temperature of +25°C. Capacitance and DF are measured at 120Hz, 0.5V RMS with a maximum DC bias of 2.2 volts. DCL is measured at rated voltage after 5 minutes.

* Insert K for ±10% and M for ±20%

NOTE: AVX reserves the right to supply higher specification parts in the same case size, to the same reliability standards.

- # **Standard Plating** – Insert R for 7" reel and S for 13" reel
- # **Gold Plating** – Insert A for 7" reel and B for 13" reel
- # **Tin Lead** – Insert H for 7" reel and K for 13" reel

For parametric information on development codes, please contact your local AVX sales office.



TAZ Series



CWR09 - MIL-PRF-55365/4



Fully qualified to MIL-PRF-55365/4, this series represents the most flexible of surface mount form factors, offering eight case sizes (A through H). This series is fully interchangeable with CWR06 conformal types, while offering the advantages of molded body/compliant termination construction, polarity and capacitance. The molded construction is compatible with a wide range of SMT board assembly processes including wave or reflow solder, conductive epoxy or compression bonding techniques.

The five smaller cases are characterized by their low profile construction, with the A case being the world's smallest molded military tantalum. There are three termination finishes available: fused solder plated ("K" per MIL-PRF-55365), hot solder dipped ("C") and gold plated ("B"). In addition, the molding compound has been selected to meet the requirements of UL94V-0 and outgassing requirements of NASA SP-R-0022A.

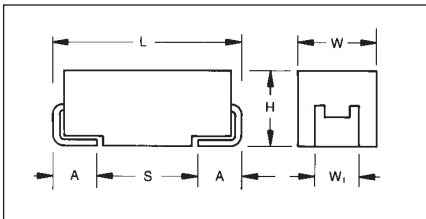

MARKING

(White marking on black body)



Polarity Stripe (+)

**Capacitance Code
Rated Voltage**

CASE DIMENSIONS:

millimeters (inches)

Case Code	Length (L) ±0.38 (0.015)	Width (W) ±0.38 (0.015)	Height (H) ±0.38 (0.015)	Term. Width (W _t)	Term. Length (A) ±0.13 (0.005)	S min
A	2.54 (0.100)	1.27 (0.050)	1.27 (0.050)	1.27±0.13 (0.050±0.005)	0.76 (0.030)	1.80 (0.071)
B	3.81 (0.150)	1.27 (0.050)	1.27 (0.050)	1.27±0.13 (0.050±0.005)	0.76 (0.030)	1.65 (0.065)
C	5.08 (0.200)	1.27 (0.050)	1.27 (0.050)	1.27±0.13 (0.050±0.005)	0.76 (0.030)	2.92 (0.115)
D	3.81 (0.150)	2.54 (0.100)	1.27 (0.050)	2.41+0.13/-0.25 (0.095+0.005/-0.010)	0.76 (0.030)	1.65 (0.065)
E	5.08 (0.200)	2.54 (0.100)	1.27 (0.050)	2.41+0.13/-0.25 (0.095+0.005/-0.010)	0.76 (0.030)	2.92 (0.115)
F	5.59 (0.220)	3.43 (0.135)	1.78 (0.070)	3.30±0.13 (0.130±0.005)	0.76 (0.030)	3.43 (0.135)
G	6.73 (0.265)	2.79 (0.110)	2.79 (0.110)	2.67±0.13 (0.105±0.005)	1.27 (0.050)	3.56 (0.140)
H	7.24 (0.285)	3.81 (0.150)	2.79 (0.110)	3.68+0.13/-0.51 (0.145+0.005/-0.020)	1.27 (0.050)	0.70 (0.028)

HOW TO ORDER

CWR09

Type

J

Voltage Code

C = 4Vdc
D = 6Vdc
F = 10Vdc
H = 15Vdc
J = 20Vdc
K = 25Vdc
M = 35Vdc
N = 50Vdc

^

Termination Finish

K = Solder Fused
C = Hot Solder Dipped
B = Gold Plated

225

Capacitance Code

pF code:
1st two digits represent significant figures
3rd digit represents multiplier (number of zeros to follow)

Capacitance Tolerance

M = ±20%
K = ±10%
J = ±5%

@

Reliability Grade

Weibull: B = 0.1%/1000 Hrs.
(90% C = 0.01%/1000 Hrs. conf.)
Comm: Z = Non ER

+

Surge Test Option

A = 10 cycles, +25°C
B = 10 cycles, -55°C & +85°C
C = 10 cycles, -55°C & +85°C before Weibull

□

Packaging

Bulk = Standard
TR = 7" T&R
TR13 = 13" T&R
W = Waffle

TECHNICAL SPECIFICATIONS

Technical Data:	Unless otherwise specified, all technical data relate to an ambient temperature of 25°C									
Capacitance Range:	0.1 µF to 100 µF									
Capacitance Tolerance:	±5%; ±10%; ±20%									
Rated Voltage: (V _R)	≤85°C:	4	6	10	15	20	25	35	50	
Category Voltage: (V _C)	125°C:	2.7	4	7	10	13	17	23	33	
Surge Voltage: (V _S)	≤85°C:	5.2	8	13	20	26	32	46	65	
	125°C:	3.4	5	8	13	16	20	28	40	
Temperature Range:	-55°C to +125°C									



TAZ Series



CWR09 - MIL-PRF-55365/4

CAPACITANCE AND RATED VOLTAGE, V_R (VOLTAGE CODE) RANGE (LETTER DENOTES CASE SIZE)

Capacitance		Rated voltage DC (V_R) at 85°C							
μF	Code	4V (C)	6V (D)	10V (F)	15V (H)	20V (J)	25V (K)	35V (M)	50V (N)
0.10	104								A
0.15	154								A
0.22	224							A	B
0.33	334						A		B
0.47	474					A		B	C
0.68	684				A	B	B	C	D
1.0	105			A		B	C	D	E
1.5	155		A		B	C	D	E	F
2.2	225	A		B	C	D	E		F
3.3	335		B	C	D	E		F	G
4.7	475	B	C	D	E		F	G	H
6.8	685	C	D	E		F	G	H	
10	106	D	E		F		G		
15	156	E		F		G	H		
22	226		F		G	H			
33	336	F		G	H				
47	476		G	H					
68	686	G	H						
100	107	H							
150	157								
220	227								



TAZ Series



CWR09 - MIL-PRF-55365/4

Part Number	Case Size	Cap (nom) (μF)	DC rated voltage (85°C) (volts)	ESR (max) 100 kHz +25°C (ohms)	DC Leakage (max)			Dissipation Factor (max)		
					+25°C (μA)	+85°C (μA)	+125°C (μA)	+25°C (%)	+85/125°C (%)	-55°C (%)
CWR09C^225*@+□	A	2.2	4	8	1	10	12	6	8	8
CWR09C^475*@+□	B	4.7	4	8	1	10	12	6	8	8
CWR09C^685*@+□	C	6.8	4	5.5	1	10	12	6	8	8
CWR09C^106*@+□	D	10	4	4	1	10	12	8	8	10
CWR09C^156*@+□	E	15	4	3.5	1	10	12	8	10	12
CWR09C^336*@+□	F	33	4	2.2	2	20	24	8	10	12
CWR09C^686*@+□	G	68	4	1.1	3	30	36	10	12	12
CWR09C^107*@+□	H	100	4	0.9	4	40	48	10	12	12
CWR09D^155*@+□	A	1.5	6	8	1	10	12	6	8	8
CWR09D^335*@+□	B	3.3	6	8	1	10	12	6	8	8
CWR09D^475*@+□	C	4.7	6	5.5	1	10	12	6	8	8
CWR09D^685*@+□	D	6.8	6	4.5	1	10	12	6	8	8
CWR09D^106*@+□	E	10	6	3.5	1	10	12	8	10	12
CWR09D^226*@+□	F	22	6	2.2	2	20	24	8	10	12
CWR09D^476*@+□	G	47	6	1.1	3	30	36	10	12	12
CWR09D^686*@+□	H	68	6	0.9	4	40	48	10	12	12
CWR09F^105*@+□	A	1	10	10	1	10	12	6	8	8
CWR09F^225*@+□	B	2.2	10	8	1	10	12	6	8	8
CWR09F^335*@+□	C	3.3	10	5.5	1	10	12	6	8	8
CWR09F^475*@+□	D	4.7	10	4.5	1	10	12	6	8	8
CWR09F^685*@+□	E	6.8	10	3.5	1	10	12	6	8	8
CWR09F^156*@+□	F	15	10	2.5	2	20	24	8	8	10
CWR09F^336*@+□	G	33	10	1.1	3	30	36	10	12	12
CWR09F^476*@+□	H	47	10	0.9	5	50	60	10	12	12
CWR09H^684*@+□	A	0.68	15	12	1	10	12	6	8	8
CWR09H^155*@+□	B	1.5	15	8	1	10	12	6	8	8
CWR09H^225*@+□	C	2.2	15	5.5	1	10	12	6	8	8
CWR09H^335*@+□	D	3.3	15	5	1	10	12	6	8	8
CWR09H^475*@+□	E	4.7	15	4	1	10	12	6	8	8
CWR09H^106*@+□	F	10	15	2.5	2	20	24	6	8	8
CWR09H^226*@+□	G	22	15	1.1	4	40	48	6	8	8
CWR09H^336*@+□	H	33	15	0.9	5	50	60	8	8	10
CWR09J^474*@+□	A	0.47	20	14	1	10	12	8	10	10
CWR09J^684*@+□	B	0.68	20	10	1	10	12	6	8	8
CWR09J^105*@+□	B	1	20	12	1	10	12	6	8	8
CWR09J^155*@+□	C	1.5	20	6	1	10	12	6	8	8
CWR09J^225*@+□	D	2.2	20	5	1	10	12	6	8	8
CWR09J^335*@+□	E	3.3	20	4	1	10	12	6	8	8
CWR09J^685*@+□	F	6.8	20	2.4	2	20	24	6	8	8
CWR09J^156*@+□	G	15	20	1.1	3	30	36	6	8	8
CWR09J^226*@+□	H	22	20	0.9	4	40	48	6	8	8
CWR09K^334*@+□	A	0.33	25	15	1	10	12	6	8	8
CWR09K^684*@+□	B	0.68	25	7.5	1	10	12	6	8	8
CWR09K^105*@+□	C	1	25	6.5	1	10	12	6	8	8



TAZ Series



CWR09 - MIL-PRF-55365/4

Part Number	Case Size	Cap (nom) (μF)	DC rated voltage (85°C) (volts)	ESR (max) 100 kHz +25°C (ohms)	DC Leakage (max)			Dissipation Factor (max)		
					+25°C (μA)	+85°C (μA)	+125°C (μA)	+25°C (%)	+85/125°C (%)	-55°C (%)
CWR09K^155*@+□	D	1.5	25	6.5	1	10	12	6	8	8
CWR09K^225*@+□	E	2.2	25	3.5	1	10	12	6	8	8
CWR09K^475*@+□	F	4.7	25	2.5	2	20	24	6	8	8
CWR09K^685*@+□	G	6.8	25	1.2	2	20	24	6	8	8
CWR09K^106*@+□	G	10	25	1.4	3	30	36	6	8	8
CWR09K^156*@+□	H	15	25	1	4	40	48	6	8	8
CWR09M^224*@+□	A	0.22	35	18	1	10	12	6	8	8
CWR09M^474*@+□	B	0.47	35	10	1	10	12	6	8	8
CWR09M^684*@+□	C	0.68	35	8	1	10	12	6	8	8
CWR09M^105*@+□	D	1	35	6.5	1	10	12	6	8	8
CWR09M^155*@+□	E	1.5	35	4.5	1	10	12	6	8	8
CWR09M^335*@+□	F	3.3	35	2.5	1	10	12	6	8	8
CWR09M^475*@+□	G	4.7	35	1.5	2	20	24	6	8	8
CWR09M^685*@+□	H	6.8	35	1.3	3	30	36	6	8	8
CWR09N^104*@+□	A	0.1	50	22	1	10	12	6	8	8
CWR09N^154*@+□	A	0.15	50	17	1	10	12	6	8	8
CWR09N^224*@+□	B	0.22	50	14	1	10	12	6	8	8
CWR09N^334*@+□	B	0.33	50	12	1	10	12	6	8	8
CWR09N^474*@+□	C	0.47	50	8	1	10	12	6	8	8
CWR09N^684*@+□	D	0.68	50	7	1	10	12	6	8	8
CWR09N^105*@+□	E	1	50	6	1	10	12	6	8	8
CWR09N^155*@+□	F	1.5	50	4	1	10	12	6	8	8
CWR09N^225*@+□	F	2.2	50	2.5	2	20	24	6	8	8
CWR09N^335*@+□	G	3.3	50	2	2	20	24	6	8	8
CWR09N^475*@+□	H	4.7	50	1.5	3	30	36	6	8	8



TAZ Series



CWR19 - MIL-PRF-55365/11



An extended range of capacitor ratings beyond CWR09 that is fully qualified to MIL-PRF-55365/11, this series represents the most flexible of surface mount form factors, offering nine case sizes. The molded construction is compatible with a wide range of SMT board assembly processes including wave or reflow solder, conductive epoxy or compression bonding techniques. The five smaller cases are characterized by their low profile con-

struction; with the A case being the world's smallest molded military tantalum. There are three termination finishes available: fused solder plated ("K" per MIL-PRF-55365), hot solder dipped ("C") and gold plated ("B"). In addition, the molding compound has been selected to meet the requirements of UL94V-0 (Flame Retardancy) and requirements of NASA SP-R-0022A (Outgassing).

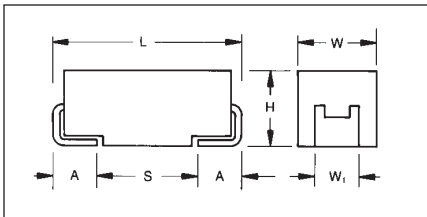

MARKING

(White marking on black body)



Polarity Stripe (+)

Capacitance Code
Rated Voltage

CASE DIMENSIONS:

millimeters (inches)

Case Code	Length (L) ±0.38 (0.015)	Width (W) ±0.38 (0.015)	Height (H) ±0.38 (0.015)	Term. Width (W _t)	Term. Length (A) ±0.13 (0.005)	S min
A	2.54 (0.100)	1.27 (0.050)	1.27 (0.050)	1.27±0.13 (0.050±0.005)	0.76 (0.030)	1.80 (0.071)
B	3.81 (0.150)	1.27 (0.050)	1.27 (0.050)	1.27±0.13 (0.050±0.005)	0.76 (0.030)	1.65 (0.065)
C	5.08 (0.200)	1.27 (0.050)	1.27 (0.050)	1.27±0.13 (0.050±0.005)	0.76 (0.030)	2.92 (0.115)
D	3.81 (0.150)	2.54 (0.100)	1.27 (0.050)	2.41±0.13/-0.25 (0.095+0.005/-0.010)	0.76 (0.030)	1.65 (0.065)
E	5.08 (0.200)	2.54 (0.100)	1.27 (0.050)	2.41±0.13/-0.25 (0.095+0.005/-0.010)	0.76 (0.030)	2.92 (0.115)
F	5.59 (0.220)	3.43 (0.135)	1.78 (0.070)	3.30±0.13 (0.130±0.005)	0.76 (0.030)	3.43 (0.135)
G	6.73 (0.265)	2.79 (0.110)	2.79 (0.110)	2.67±0.13 (0.105±0.005)	1.27 (0.050)	3.56 (0.140)
H	7.24 (0.285)	3.81 (0.150)	2.79 (0.110)	3.68±0.13/-0.51 (0.145+0.005/-0.020)	1.27 (0.050)	0.70 (0.028)
X	6.93 Max (0.273)	5.41 Max (0.213)	2.74 Max (0.108)	3.05±0.13 (0.120±0.005)	1.19 (0.047)	N/A

HOW TO ORDER

CWR19	J	-	225	*	@	D	+	□
Type	Voltage Code	Termination Finish	Capacitance Code	Capacitance Tolerance	Reliability Grade	Case Size	Surge Test Option	Packaging
C = 4Vdc D = 6Vdc F = 10Vdc H = 15Vdc J = 20Vdc K = 25Vdc M = 35Vdc N = 50Vdc	K = Fused Solder Plated C = Hot Solder Dipped B = Gold Plated	pF code: 1st two digits represent significant figures 3rd digit represents multiplier (number of zeros to follow)	M = ±20% K = ±10% J = ±5%	Weibull: B = 0.1%/1000 Hrs. (90% C = 0.01%/1000 Hrs. conf.) Comm: Z = Non ER	A = 10 cycles, +25°C B = 10 cycles, -55°C & +85°C C = 10 cycles, -55°C & +85°C before Weibull Z = None required	Bulk = Standard TR = 7" T&R TR13 = 13" T&R W = Waffle		

TECHNICAL SPECIFICATIONS

Technical Data:	Unless otherwise specified, all technical data relate to an ambient temperature of 25°C									
Capacitance Range:	0.33 µF to 330 µF									
Capacitance Tolerance:	±5%; ±10%; ±20%									
Rated Voltage: (V _R)	≤85°C:	4	6	10	15	20	25	35	50	
Category Voltage: (V _C)	125°C:	2.7	4	7	10	13	17	23	33	
Surge Voltage: (V _S)	≤85°C:	5.2	8	13	20	26	32	46	65	
	125°C:	3.4	5	8	13	16	20	28	40	
Temperature Range:	-55°C to +125°C									



TAZ Series



CWR19 - MIL-PRF-55365/11

CAPACITANCE AND RATED VOLTAGE, V_R (VOLTAGE CODE) RANGE (LETTER DENOTES CASE SIZE)

Capacitance		Rated voltage DC (V_R) at 85°C							
μF	Code	4V (C)	6V (D)	10V (F)	15V (H)	20V (J)	25V (K)	35V (M)	50V (N)
0.10	104								
0.15	154								
0.22	224								
0.33	334							A	
0.47	474						A		C
0.68	684					A		C	
1.0	105				A	A	B/C		
1.5	155				A	B/C			
2.2	225			A	A/C	B	D		
3.3	335	A	A	A/C	B	D	E		
4.7	475	A	A/C	B/C	B/C/D	E			
6.8	685	A/C	B	B/C/D	D/E	E	F	G	
10	106	B	B	B/C/D/E	D/E	E/F		H	
15	156	B	B/D/E	D/E	E/F	F	G	X	
22	226	B/D	D/E	E	F	G	G/H/X		
33	336	D/E	E	F	F/G	H	H/X		
47	476	E	F	F/G	G/H	H/X			
68	686	E	F/G	G	G/H				
100	107	F	G	G/H	H				
150	157	G	G	H/X					
220	227	G	H	H					
330	337	H	H						



TAZ Series



CWR19 - MIL-PRF-55365/11

Part Number	Case Size	Cap (nom) (μF)	DC rated voltage (85°C) (volts)	ESR (max) 100 kHz +25°C (ohms)	DC Leakage (max)			Dissipation Factor (max)		
					+25°C (μA)	+85°C (μA)	+125°C (μA)	+25°C (%)	+85/125°C (%)	-55°C (%)
CWR19C-335*@A+□	A	3.3	4	12	1	10	12	6	8	8
CWR19C-475*@A+□	A	4.7	4	12	1	10	12	6	8	8
CWR19C-685*@A+□	A	6.8	4	12	1	10	12	6	8	8
CWR19C-685*@C+□	C	6.8	4	5.5	1	10	12	6	8	8
CWR19C-106*@B+□	B	10	4	8	1	10	12	8	10	10
CWR19C-156*@B+□	B	15	4	8	1	10	12	8	10	10
CWR19C-226*@B+□	B	22	4	8	1	10	12	8	10	10
CWR19C-226*@D+□	D	22	4	4	1	10	12	8	10	12
CWR19C-336*@D+□	D	33	4	4	2	20	24	8	10	12
CWR19C-336*@E+□	E	33	4	3	2	20	24	8	10	12
CWR19C-476*@E+□	E	47	4	3	2	20	24	8	10	12
CWR19C-686*@E+□	E	68	4	3	3	30	36	8	10	12
CWR19C-107*@F+□	F	100	4	2	4	40	48	10	12	12
CWR19C-157*@G+□	G	150	4	1	6	60	72	10	12	12
CWR19C-227*@H+□	H	220	4	1	8	80	96	10	12	12
CWR19C-337*@H+□	H	330	4	0.9	10	100	120	10	12	12
CWR19D-335*@A+□	A	3.3	6	12	1	10	12	6	8	8
CWR19D-475*@A+□	A	4.7	6	12	1	10	12	6	8	8
CWR19D-475*@C+□	C	4.7	6	5.5	1	10	12	6	8	8
CWR19D-685*@B+□	B	6.8	6	8	1	10	12	6	8	8
CWR19D-106*@B+□	B	10	6	8	1	10	12	6	8	8
CWR19D-156*@B+□	B	15	6	8	1	10	12	8	10	10
CWR19D-156*@D+□	D	15	6	5	1	10	12	8	10	12
CWR19D-156*@E+□	E	15	6	3	1	10	12	8	10	12
CWR19D-226*@D+□	D	22	6	5	1	10	12	6	8	8
CWR19D-226*@E+□	E	22	6	3.5	2	20	24	8	10	12
CWR19D-336*@E+□	E	33	6	3.5	2	20	24	6	8	8
CWR19D-476*@F+□	F	47	6	3.5	3	30	36	8	10	12
CWR19D-686*@F+□	F	68	6	1.5	4	40	48	10	12	12
CWR19D-686*@G+□	G	68	6	1	4	40	48	10	12	12
CWR19D-107*@G+□	G	100	6	1.1	6	60	72	10	12	12
CWR19D-157*@G+□	G	150	6	1.1	10	100	120	10	12	12
CWR19D-227*@H+□	H	220	6	0.9	10	100	120	10	12	12
CWR19D-337*@H+□	H	330	6	0.9	20	200	240	10	12	12
CWR19F-225*@A+□	A	2.2	10	12	1	10	12	6	8	8
CWR19F-335*@A+□	A	3.3	10	12	1	10	12	6	8	8
CWR19F-335*@C+□	C	3.3	10	5.5	1	10	12	6	8	8
CWR19F-475*@B+□	B	4.7	10	8	1	10	12	6	8	8
CWR19F-475*@C+□	C	4.7	10	5.5	1	10	12	6	8	8
CWR19F-685*@B+□	B	6.8	10	8	1	10	12	6	8	8
CWR19F-685*@C+□	C	6.8	10	5.5	1	10	12	6	8	8
CWR19F-685*@D+□	D	6.8	10	5	1	10	12	6	8	8
CWR19F-106*@B+□	B	10	10	8	1	10	12	8	10	10



TAZ Series



CWR19 - MIL-PRF-55365/11

Part Number	Case Size	Cap (nom) (μF)	DC rated voltage (85°C) (volts)	ESR (max) 100 kHz +25°C (ohms)	DC Leakage (max)			Dissipation Factor (max)		
					+25°C (μA)	+85°C (μA)	+125°C (μA)	+25°C (%)	+85/125°C (%)	-55°C (%)
CWR19F-106*@C+□	C	10	10	5.5	1	10	12	6	8	8
CWR19F-106*@D+□	D	10	10	4	1	10	12	6	8	8
CWR19F-106*@E+□	E	10	10	3.5	1	10	12	6	8	8
CWR19F-156*@D+□	D	15	10	5	2	20	24	6	8	8
CWR19F-156*@E+□	E	15	10	3	2	20	24	8	10	10
CWR19F-226*@E+□	E	22	10	2	3	30	36	8	10	10
CWR19F-336*@F+□	F	33	10	1.5	3	30	36	8	10	10
CWR19F-476*@F+□	F	47	10	1.5	4	40	48	10	12	12
CWR19F-476*@G+□	G	47	10	1	4	40	48	10	12	12
CWR19F-686*@G+□	G	68	10	1.1	6	60	72	10	12	12
CWR19F-107*@G+□	G	100	10	1.1	10	100	120	10	12	12
CWR19F-107*@H+□	H	100	10	0.9	10	100	120	10	12	12
CWR19F-157*@H+□	H	150	10	0.9	15	150	180	10	12	12
CWR19F-157*@X+□	X	150	10	0.9	15	150	180	10	12	12
CWR19F-227*@H+□	H	220	10	0.9	20	200	240	10	12	12
CWR19H-105*@A+□	A	1	15	15	1	10	12	6	8	8
CWR19H-155*@A+□	A	1.5	15	15	1	10	12	6	8	8
CWR19H-225*@A+□	A	2.2	15	15	1	10	12	6	8	8
CWR19H-225*@C+□	C	2.2	15	5.5	1	10	12	6	8	8
CWR19H-335*@B+□	B	3.3	15	9	1	10	12	6	8	8
CWR19H-475*@B+□	B	4.7	15	5	1	10	12	6	8	8
CWR19H-475*@C+□	C	4.7	15	5.5	1	10	12	6	8	8
CWR19H-475*@D+□	D	4.7	15	6	1	10	12	6	8	8
CWR19H-685*@D+□	D	6.8	15	6	1	10	12	6	8	8
CWR19H-685*@E+□	E	6.8	15	3	1	10	12	8	10	12
CWR19H-106*@D+□	D	10	15	6	2	20	24	6	8	8
CWR19H-106*@E+□	E	10	15	4	2	20	24	6	8	8
CWR19H-156*@E+□	E	15	15	4	2	20	24	6	8	8
CWR19H-156*@F+□	F	15	15	3	2	20	24	8	10	10
CWR19H-226*@F+□	F	22	15	3	3	30	36	8	10	10
CWR19H-336*@F+□	F	33	15	3	5	50	60	6	8	8
CWR19H-336*@G+□	G	33	15	1.1	6	60	72	8	10	10
CWR19H-476*@G+□	G	47	15	1.1	10	100	120	8	10	10
CWR19H-476*@H+□	H	47	15	0.9	10	100	120	8	10	10
CWR19H-686*@G+□	G	68	15	1.1	10	100	120	8	10	10
CWR19H-686*@H+□	H	68	15	0.9	10	100	120	8	10	10
CWR19H-107*@H+□	H	100	15	0.9	15	150	180	10	12	12
CWR19J-684*@A+□	A	0.68	20	15	1	10	12	6	8	8
CWR19J-105*@A+□	A	1	20	15	1	10	12	6	8	8
CWR19J-155*@B+□	B	1.5	20	9	1	10	12	6	8	8
CWR19J-155*@C+□	C	1.5	20	6	1	10	12	6	8	8
CWR19J-225*@B+□	B	2.2	20	9	1	10	12	6	8	8
CWR19J-335*@D+□	D	3.3	20	6	1	10	12	6	8	8



TAZ Series



CWR19 - MIL-PRF-55365/11

Part Number	Case Size	Cap (nom) (μF)	DC rated voltage (85°C) (volts)	ESR (max) 100 kHz +25°C (ohms)	DC Leakage (max)			Dissipation Factor (max)		
					+25°C (μA)	+85°C (μA)	+125°C (μA)	+25°C (%)	+85/125°C (%)	-55°C (%)
CWR19J-475*@E+□	E	4.7	20	6	1	10	12	6	8	8
CWR19J-685*@E+□	E	6.8	20	5	2	20	24	6	8	8
CWR19J-106*@E+□	E	10	20	5	2	20	24	6	8	8
CWR19J-106*@F+□	F	10	20	3	2	20	24	6	8	8
CWR19J-156*@F+□	F	15	20	3	3	30	36	6	8	8
CWR19J-226*@G+□	G	22	20	2.5	4	40	48	6	8	8
CWR19J-336*@H+□	H	33	20	0.9	6	60	72	8	10	10
CWR19J-476*@H+□	H	47	20	0.9	10	100	120	8	10	10
CWR19J-476*@X+□	X	47	20	0.9	10	100	120	8	10	10
CWR19K-474*@A+□	A	0.47	25	15	1	10	12	6	8	8
CWR19K-105*@B+□	B	1	25	10	1	10	12	6	8	8
CWR19K-105*@C+□	C	1	25	6.5	1	10	12	6	8	8
CWR19K-225*@D+□	D	2.2	25	6	1	10	12	6	8	8
CWR19K-335*@E+□	E	3.3	25	4	1	10	12	6	8	8
CWR19K-685*@F+□	F	6.8	25	3	2	20	24	6	8	8
CWR19K-156*@G+□	G	15	25	1.4	4	40	48	6	8	8
CWR19K-226*@G+□	G	22	25	1.4	6	60	72	6	8	8
CWR19K-226*@H+□	H	22	25	0.9	6	60	72	6	8	8
CWR19K-226*@X+□	X	22	25	0.9	6	60	72	6	8	8
CWR19K-336*@H+□	H	33	25	0.9	10	100	120	8	10	10
CWR19K-336*@X+□	X	33	25	0.9	10	100	120	8	10	10
CWR19M-334*@A+□	A	0.33	35	22	1	10	12	6	8	8
CWR19M-684*@C+□	C	0.68	35	10	1	10	12	6	8	8
CWR19M-685*@G+□	G	6.8	35	1.5	3	30	36	6	8	8
CWR19M-106*@H+□	H	10	35	0.9	4	40	48	8	10	10
CWR19M-156*@X+□	X	15	35	0.9	6	60	72	6	8	8
CWR19N-474*@C+□	C	0.47	50	8	1	10	12	6	8	8



TAZ Series



CWR29 - MIL-PRF-55365/11



A low ESR version of CWR09 and CWR19 that is fully qualified to MIL-PRF-55365/11, this series represents the most flexible of surface mount form factors, offering nine case sizes. The molded construction is compatible with a wide range of SMT board assembly processes including wave or reflow solder, conductive epoxy or compression bonding techniques. The five smaller cases are characterized by their low profile construction; with the

A case being the world's smallest molded military tantalum. There are three termination finishes available: fused solder plated ("K" per MIL-PRF-55365), hot solder dipped ("C") and gold plated ("B"). In addition, the molding compound has been selected to meet the requirements of UL94V-0 (Flame Retardancy) and requirements of NASA SP-R-0022A (Outgassing).

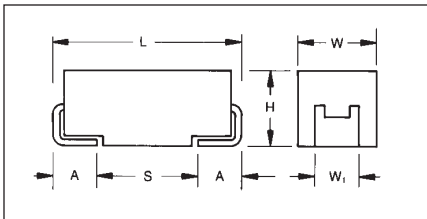

CASE DIMENSIONS:

millimeters (inches)

Case Code	Length (L) ±0.38 (0.015)	Width (W) ±0.38 (0.015)	Height (H) ±0.38 (0.015)	Term. Width (W _t)	Term. Length (A) ±0.13 (0.005)	S min
A	2.54 (0.100)	1.27 (0.050)	1.27 (0.050)	1.27±0.13 (0.050±0.005)	0.76 (0.030)	1.80 (0.071)
B	3.81 (0.150)	1.27 (0.050)	1.27 (0.050)	1.27±0.13 (0.050±0.005)	0.76 (0.030)	1.65 (0.065)
C	5.08 (0.200)	1.27 (0.050)	1.27 (0.050)	1.27±0.13 (0.050±0.005)	0.76 (0.030)	2.92 (0.115)
D	3.81 (0.150)	2.54 (0.100)	1.27 (0.050)	2.41±0.13/-0.25 (0.095+0.005/-0.010)	0.76 (0.030)	1.65 (0.065)
E	5.08 (0.200)	2.54 (0.100)	1.27 (0.050)	2.41±0.13/-0.25 (0.095+0.005/-0.010)	0.76 (0.030)	2.92 (0.115)
F	5.59 (0.220)	3.43 (0.135)	1.78 (0.070)	3.30±0.13 (0.130±0.005)	0.76 (0.030)	3.43 (0.135)
G	6.73 (0.265)	2.79 (0.110)	2.79 (0.110)	2.67±0.13 (0.105±0.005)	1.27 (0.050)	3.56 (0.140)
H	7.24 (0.285)	3.81 (0.150)	2.79 (0.110)	3.68±0.13/-0.51 (0.145+0.005/-0.020)	1.27 (0.050)	0.70 (0.028)
X	6.93 Max (0.273)	5.41 Max (0.213)	2.74 Max (0.108)	3.05±0.13 (0.120±0.005)	1.19 (0.047)	N/A

MARKING

(White marking on black body)



Polarity Stripe (+)

Capacitance Code
Rated Voltage

HOW TO ORDER

CWR29	J	-	225	*	@	D	+	□
Type	Voltage Code	Termination Finish	Capacitance Code	Capacitance Tolerance	Reliability Grade	Case Size	Surge Test Option	Packaging
	C = 4Vdc D = 6Vdc F = 10Vdc H = 15Vdc J = 20Vdc K = 25Vdc M = 35Vdc N = 50Vdc	K = Fused Solder Plated C = Hot Solder Dipped B = Gold Plated	pF code: 1st two digits represent significant figures 3rd digit represents multiplier (number of zeros to follow)	M = ±20% K = ±10% J = ±5%	Weibull: B = 0.1%/1000 Hrs. (90% C = 0.01%/1000 Hrs. conf.) Comm: Z = Non ER		A = 10 cycles, +25°C B = 10 cycles, -55°C & +85°C C = 10 cycles, -55°C & +85°C before Weibull Z = None required	Bulk = Standard TR = 7" T&R TR13 = 13" T&R W = Waffle

TECHNICAL SPECIFICATIONS

Technical Data:	Unless otherwise specified, all technical data relate to an ambient temperature of 25°C									
Capacitance Range:	0.33 µF to 330 µF									
Capacitance Tolerance:	±5%; ±10%; ±20%									
Rated Voltage: (V _R)	≤85°C:	4	6	10	15	20	25	35	50	
Category Voltage: (V _C)	125°C:	2.7	4	7	10	13	17	23	33	
Surge Voltage: (V _S)	≤85°C:	5.2	8	13	20	26	32	46	65	
	125°C:	3.4	5	8	13	16	20	28	40	
Temperature Range:	-55°C to +125°C									



TAZ Series



CWR29 - MIL-PRF-55365/11

CAPACITANCE AND RATED VOLTAGE, V_R (VOLTAGE CODE) RANGE (LETTER DENOTES CASE SIZE)

Capacitance		Rated voltage DC (V_R) at 85°C							
μF	Code	4V (C)	6V (D)	10V (F)	15V (H)	20V (J)	25V (K)	35V (M)	50V (N)
0.10	104								A
0.15	154								A
0.22	224							A	B
0.33	334						A	A	B
0.47	474					A	A	B	C
0.68	684				A	A/B	B	C	D
1.0	105			A	A	A/B	B/C	D	E
1.5	155		A		A/B	B/C	D	E	F
2.2	225	A		A/B	A/C	B/D	D/E		F
3.3	335	A	A/B	A/C	B/D	D/E	E	F	G
4.7	475	A/B	A/C	B/C/D	B/C/D/E	E	F	G	H
6.8	685	A/C	B/D	B/C/D/E	D/E	E/F	F/G	G/H	
10	106	B/D	B/E	B/C/D/E	D/E/F	E/F	G	H	
15	156	B/E	B/D/E	D/E/F	E/F	F/G	G/H	X	
22	226	B/D	D/E/F	E	F/G	G/H	G/H/X		
33	336	D/E/F	E	F/G	F/G/H	H	H/X		
47	476	E	F/G	F/G/H	G/H	H/X			
68	686	E/G	F/G/H	G	G/H				
100	107	F/H	G	G/H	H				
150	157	G	G	H/X					
220	227	G	H	H					
330	337	H	H						



TAZ Series



CWR29 - MIL-PRF-55365/11

Part Number	Case Size	Cap (nom) (μF)	DC rated voltage (85°C) (volts)	ESR (max) 100 kHz +25°C (ohms)	DC Leakage (max)			Dissipation Factor (max)		
					+25°C (μA)	+85°C (μA)	+125°C (μA)	+25°C (%)	+85/125°C (%)	-55°C (%)
CWR29C-225*@A+□	A	2.2	4	4	1	10	12	6	8	8
CWR29C-335*@A+□	A	3.3	4	6	1	10	12	6	8	8
CWR29C-475*@A+□	A	4.7	4	6	1	10	12	6	8	8
CWR29C-475*@B+□	B	4.7	4	3.2	1	10	12	6	8	8
CWR29C-685*@A+□	A	6.8	4	6	1	10	12	6	8	8
CWR29C-685*@C+□	C	6.8	4	2.2	1	10	12	6	8	8
CWR29C-106*@B+□	B	10	4	3.2	1	10	12	8	10	10
CWR29C-106*@D+□	D	10	4	1.3	1	10	12	8	8	10
CWR29C-156*@B+□	B	15	4	3.2	1	10	12	8	10	10
CWR29C-156*@E+□	E	15	4	1	1	10	12	8	10	12
CWR29C-226*@B+□	B	22	4	3.2	1	10	12	8	10	10
CWR29C-226*@D+□	D	22	4	1.3	1	10	12	8	10	12
CWR29C-336*@D+□	D	33	4	1.3	2	20	24	8	10	12
CWR29C-336*@E+□	E	33	4	0.9	2	20	24	8	10	12
CWR29C-336*@F+□	F	33	4	0.6	2	20	24	8	10	12
CWR29C-476*@E+□	E	47	4	0.9	2	20	24	8	10	12
CWR29C-686*@E+□	E	68	4	0.9	3	30	36	8	10	12
CWR29C-686*@G+□	G	68	4	0.275	3	30	36	10	12	12
CWR29C-107*@F+□	F	100	4	0.55	4	40	48	10	12	12
CWR29C-107*@H+□	H	100	4	0.18	4	40	48	10	12	12
CWR29C-157*@G+□	G	150	4	0.25	6	60	72	10	12	12
CWR29C-227*@H+□	H	220	4	0.2	8	80	96	10	12	12
CWR29C-337*@H+□	H	330	4	0.18	10	100	120	10	12	12
CWR29D-155*@A+□	A	1.5	6	4	1	10	12	6	8	8
CWR29D-335*@A+□	A	3.3	6	6	1	10	12	6	8	8
CWR29D-335*@B+□	B	3.3	6	3.2	1	10	12	6	8	8
CWR29D-475*@A+□	A	4.7	6	6	1	10	12	6	8	8
CWR29D-475*@C+□	C	4.7	6	2.2	1	10	12	6	8	8
CWR29D-685*@B+□	B	6.8	6	3.2	1	10	12	6	8	8
CWR29D-685*@D+□	D	6.8	6	1.5	1	10	12	6	8	8
CWR29D-106*@B+□	B	10	6	3.2	1	10	12	6	8	8
CWR29D-106*@E+□	E	10	6	1	1	10	12	8	10	12
CWR29D-156*@B+□	B	15	6	3.2	1	10	12	8	10	10
CWR29D-156*@D+□	D	15	6	1.7	1	10	12	8	10	12
CWR29D-156*@E+□	E	15	6	0.9	1	10	12	8	10	12
CWR29D-226*@D+□	D	22	6	1.7	1	10	12	6	8	8
CWR29D-226*@E+□	E	22	6	1	2	20	24	8	10	12
CWR29D-226*@F+□	F	22	6	0.6	2	20	24	8	10	12
CWR29D-336*@E+□	E	33	6	1	2	20	24	6	8	8
CWR29D-476*@F+□	F	47	6	1	3	30	36	8	10	12
CWR29D-476*@G+□	G	47	6	0.275	3	30	36	10	12	12
CWR29D-686*@F+□	F	68	6	0.4	4	40	48	10	12	12
CWR29D-686*@G+□	G	68	6	0.25	4	40	48	10	12	12



TAZ Series



CWR29 - MIL-PRF-55365/11

Part Number	Case Size	Cap (nom) (μF)	DC rated voltage (85°C) (volts)	ESR (max) 100 kHz +25°C (ohms)	DC Leakage (max)			Dissipation Factor (max)		
					+25°C (μA)	+85°C (μA)	+125°C (μA)	+25°C (%)	+85/125°C (%)	-55°C (%)
CWR29D-686*@H+□	H	68	6	0.18	4	40	48	10	12	12
CWR29D-107*@G+□	G	100	6	0.275	6	60	72	10	12	12
CWR29D-157*@G+□	G	150	6	0.275	10	100	120	10	12	12
CWR29D-227*@H+□	H	220	6	0.18	10	100	120	10	12	12
CWR29D-337*@H+□	H	330	6	0.18	20	200	240	10	12	12
CWR29F-105*@A+□	A	1	10	5	1	10	12	6	8	8
CWR29F-225*@A+□	A	2.2	10	6	1	10	12	6	8	8
CWR29F-225*@B+□	B	2.2	10	3.2	1	10	12	6	8	8
CWR29F-335*@A+□	A	3.3	10	6	1	10	12	6	8	8
CWR29F-335*@C+□	C	3.3	10	2.2	1	10	12	6	8	8
CWR29F-475*@B+□	B	4.7	10	3.2	1	10	12	6	8	8
CWR29F-475*@C+□	C	4.7	10	2.2	1	10	12	6	8	8
CWR29F-475*@D+□	D	4.7	10	1.5	1	10	12	6	8	8
CWR29F-685*@B+□	B	6.8	10	3.2	1	10	12	6	8	8
CWR29F-685*@C+□	C	6.8	10	2.2	1	10	12	6	8	8
CWR29F-685*@D+□	D	6.8	10	1.7	1	10	12	6	8	8
CWR29F-685*@E+□	E	6.8	10	1	1	10	12	6	8	8
CWR29F-106*@B+□	B	10	10	3.2	1	10	12	8	10	10
CWR29F-106*@C+□	C	10	10	2.2	1	10	12	6	8	8
CWR29F-106*@D+□	D	10	10	1.3	1	10	12	6	8	8
CWR29F-106*@E+□	E	10	10	1	1	10	12	6	8	8
CWR29F-156*@D+□	D	15	10	1.7	2	20	24	6	8	8
CWR29F-156*@E+□	E	15	10	0.9	2	20	24	8	10	10
CWR29F-156*@F+□	F	15	10	0.7	2	20	24	8	8	10
CWR29F-226*@E+□	E	22	10	0.6	3	30	36	8	10	10
CWR29F-336*@F+□	F	33	10	0.4	3	30	36	8	10	10
CWR29F-336*@G+□	G	33	10	0.275	3	30	36	10	12	12
CWR29F-476*@F+□	F	47	10	0.4	4	40	48	10	12	12
CWR29F-476*@G+□	G	47	10	0.25	4	40	48	10	12	12
CWR29F-476*@H+□	H	47	10	0.18	5	50	60	10	12	12
CWR29F-686*@G+□	G	68	10	0.275	6	60	72	10	12	12
CWR29F-107*@G+□	G	100	10	0.275	10	100	120	10	12	12
CWR29F-107*@H+□	H	100	10	0.18	10	100	120	10	12	12
CWR29F-157*@H+□	H	150	10	0.18	15	150	180	10	12	12
CWR29F-157*@X+□	X	150	10	0.065	15	150	180	10	12	12
CWR29F-227*@H+□	H	220	10	0.18	20	200	240	10	12	12
CWR29H^684*@A+□	A	0.68	15	6	1	10	12	6	8	8
CWR29H^105*@A+□	A	1	15	7.5	1	10	12	6	8	8
CWR29H^155*@A+□	A	1.5	15	7.5	1	10	12	6	8	8
CWR29H^155*@B+□	B	1.5	15	3.2	1	10	12	6	8	8
CWR29H^225*@A+□	A	2.2	15	7.5	1	10	12	6	8	8
CWR29H^225*@C+□	C	2.2	15	2.2	1	10	12	6	8	8
CWR29H^335*@B+□	B	3.3	15	3.6	1	10	12	6	8	8
CWR29H^335*@D+□	D	3.3	15	1.7	1	10	12	6	8	8



TAZ Series



CWR29 - MIL-PRF-55365/11

Part Number	Case Size	Cap (nom) (μF)	DC rated voltage (85°C) (volts)	ESR (max) 100 kHz +25°C (ohms)	DC Leakage (max)			Dissipation Factor (max)		
					+25°C (μA)	+85°C (μA)	+125°C (μA)	+25°C (%)	+85/125°C (%)	-55°C (%)
CWR29H-475*@B+□	B	4.7	15	2	1	10	12	6	8	8
CWR29H-475*@C+□	C	4.7	15	2.2	1	10	12	6	8	8
CWR29H-475*@D+□	D	4.7	15	2	1	10	12	6	8	8
CWR29H-475*@E+□	E	4.7	15	1.2	1	10	12	6	8	8
CWR29H-685*@D+□	D	6.8	15	2	1	10	12	6	8	8
CWR29H-685*@E+□	E	6.8	15	0.9	1	10	12	8	10	12
CWR29H-106*@D+□	D	10	15	2	2	20	24	6	8	8
CWR29H-106*@E+□	E	10	15	1.2	2	20	24	6	8	8
CWR29H-106*@F+□	F	10	15	0.667	2	20	24	6	8	8
CWR29H-156*@E+□	E	15	15	1.2	2	20	24	6	8	8
CWR29H-156*@F+□	F	15	15	0.8	2	20	24	8	10	10
CWR29H-226*@F+□	F	22	15	0.8	3	30	36	8	10	10
CWR29H-226*@G+□	G	22	15	0.275	4	40	48	6	8	8
CWR29H-336*@F+□	F	33	15	0.8	5	50	60	6	8	8
CWR29H-336*@G+□	G	33	15	0.275	6	60	72	8	10	10
CWR29H-336*@H+□	H	33	15	0.18	5	50	60	8	8	10
CWR29H-476*@G+□	G	47	15	0.275	10	100	120	8	10	10
CWR29H-476*@H+□	H	47	15	0.18	10	100	120	8	10	10
CWR29H-686*@G+□	G	68	15	0.275	10	100	120	8	10	10
CWR29H-686*@H+□	H	68	15	0.18	10	100	120	8	10	10
CWR29H-107*@H+□	H	100	15	0.18	15	150	180	10	12	12
CWR29J-474*@A+□	A	0.47	20	7.5	1	10	12	8	8	10
CWR29J-684*@A+□	A	0.68	20	7.5	1	10	12	6	8	8
CWR29J-684*@B+□	B	0.68	20	5.6	1	10	12	6	8	8
CWR29J-105*@A+□	A	1	20	7.5	1	10	12	6	8	8
CWR29J-105*@B+□	B	1	20	4.8	1	10	12	6	8	8
CWR29J-155*@B+□	B	1.5	20	3.6	1	10	12	6	8	8
CWR29J-155*@C+□	C	1.5	20	2.4	1	10	12	6	8	8
CWR29J-225*@B+□	B	2.2	20	3.6	1	10	12	6	8	8
CWR29J-225*@D+□	D	2.2	20	1.7	1	10	12	6	8	8
CWR29J-335*@D+□	D	3.3	20	2	1	10	12	6	8	8
CWR29J-335*@E+□	E	3.3	20	1.2	1	10	12	6	8	8
CWR29J-475*@E+□	E	4.7	20	1.7	1	10	12	6	8	8
CWR29J-685*@E+□	E	6.8	20	1.5	2	20	24	6	8	8
CWR29J-685*@F+□	F	6.8	20	0.7	2	20	24	6	8	8
CWR29J-106*@E+□	E	10	20	1.5	2	20	24	6	8	8
CWR29J-106*@F+□	F	10	20	0.8	2	20	24	6	8	8
CWR29J-156*@F+□	F	15	20	0.8	3	30	36	6	8	8
CWR29J-156*@G+□	G	15	20	0.275	3	30	36	6	8	8
CWR29J-226*@G+□	G	22	20	0.625	4	40	48	6	8	8
CWR29J-226*@H+□	H	22	20	0.18	4	40	48	6	8	8
CWR29J-336*@H+□	H	33	20	0.18	6	60	72	8	10	10
CWR29J-476*@H+□	H	47	20	0.18	10	100	120	8	10	10
CWR29J-476*@X+□	X	47	20	0.11	10	100	120	8	10	10



TAZ Series



CWR29 - MIL-PRF-55365/11

Part Number	Case Size	Cap (nom) (μF)	DC rated voltage (85°C) (volts)	ESR (max) 100 kHz +25°C (ohms)	DC Leakage (max)			Dissipation Factor (max)		
					+25°C (μA)	+85°C (μA)	+125°C (μA)	+25°C (%)	+85/125°C (%)	-55°C (%)
CWR29K-334*@A+□	A	0.33	25	7.5	1	10	12	6	8	8
CWR29K-474*@A+□	A	0.47	25	7.5	1	10	12	6	8	8
CWR29K-684*@B+□	B	0.68	25	4	1	10	12	6	8	8
CWR29K-105*@B+□	B	1	25	4	1	10	12	6	8	8
CWR29K-105*@C+□	C	1	25	2.6	1	10	12	6	8	8
CWR29K-155*@D+□	D	1.5	25	1.7	1	10	12	6	8	8
CWR29K-225*@D+□	D	2.2	25	2	1	10	12	6	8	8
CWR29K-225*@E+□	E	2.2	25	1	1	10	12	6	8	8
CWR29K-335*@E+□	E	3.3	25	1.2	1	10	12	6	8	8
CWR29K-475*@F+□	F	4.7	25	0.7	2	20	24	6	8	8
CWR29K-685*@F+□	F	6.8	25	0.8	2	20	24	6	8	8
CWR29K-685*@G+□	G	6.8	25	0.3	2	20	24	6	8	8
CWR29K-106*@G+□	G	10	25	0.35	3	30	36	6	8	8
CWR29K-156*@G+□	G	15	25	0.35	4	40	48	6	8	8
CWR29K-156*@H+□	H	15	25	0.2	4	40	48	6	8	8
CWR29K-226*@G+□	G	22	25	0.35	6	60	72	6	8	8
CWR29K-226*@H+□	H	22	25	0.18	6	60	72	6	8	8
CWR29K-226*@X+□	X	22	25	0.16	6	60	72	6	8	8
CWR29K-336*@H+□	H	33	25	0.18	10	100	120	6	8	8
CWR29K-336*@X+□	X	33	25	0.13	10	100	120	8	10	10
CWR29M-224*@A+□	A	0.22	35	12	1	10	12	6	8	8
CWR29M-334*@A+□	A	0.33	35	12	1	10	12	6	8	8
CWR29M-474*@B+□	B	0.47	35	6.8	1	10	12	6	8	8
CWR29M-684*@C+□	C	0.68	35	4	1	10	12	6	8	8
CWR29M-105*@D+□	D	1	35	2.2	1	10	12	6	8	8
CWR29M-155*@E+□	E	1.5	35	1.3	1	10	12	6	8	8
CWR29M-335*@F+□	F	3.3	35	0.7	1	10	12	6	8	8
CWR29M-475*@G+□	G	4.7	35	0.375	2	20	24	6	8	8
CWR29M-685*@G+□	G	6.8	35	0.375	3	30	36	6	8	8
CWR29M-685*@H+□	H	6.8	35	0.5	3	30	36	6	8	8
CWR29M-106*@H+□	H	10	35	0.5	4	40	48	8	10	10
CWR29M-156*@X+□	X	15	35	0.19	6	60	72	6	8	8
CWR29N-104*@A+□	A	0.1	50	12	1	10	12	6	8	8
CWR29N-154*@A+□	A	0.15	50	12	1	10	12	6	8	8
CWR29N-224*@B+□	B	0.22	50	6.8	1	10	12	6	8	8
CWR29N-334*@B+□	B	0.33	50	4.8	1	10	12	6	8	8
CWR29N-474*@C+□	C	0.47	50	3.2	1	10	12	6	8	8
CWR29N-684*@D+□	D	0.68	50	2.3	1	10	12	6	8	8
CWR29N-105*@E+□	E	1	50	1.7	1	10	12	6	8	8
CWR29N-155*@F+□	F	1.5	50	1.1	1	10	12	6	8	8
CWR29N-225*@F+□	F	2.2	50	0.7	2	20	24	6	8	8
CWR29N-335*@G+□	G	3.3	50	0.5	2	20	24	6	8	8
CWR29N-475*@H+□	H	4.7	50	0.5	3	30	36	6	8	8



TAZ Series



COTS-Plus



The TAZ part has fully molded, compliant leadframe construction designed for use in applications utilizing solder (Reflow, Wave or Vapor Phase), conductive adhesive or thermal compression bonding techniques. Each chip is marked with polarity, capacitance code and rate voltage.

The series comprises ten case sizes (see dimensional chart below) with the maximum size V case giving capacitance values to 470 μ F. The C case, with its non-standard aspect ratio, is retained as a QPL (Qualified Product List) only special.

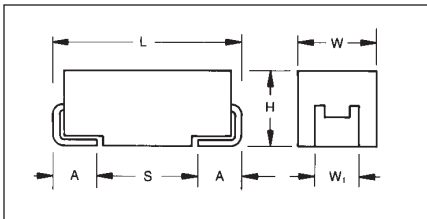

MARKING

(White marking on black body)



Polarity Stripe (+)

**Capacitance Code
Rated Voltage**

CASE DIMENSIONS:

millimeters (inches)

Case Code	Length (L) ± 0.38 (0.015)	Width (W) ± 0.38 (0.015)	Height (H) ± 0.38 (0.015)	Term. Width (W _t)	Term. Length (A) ± 0.13 (0.005)	S min
A	2.54 (0.100)	1.27 (0.050)	1.27 (0.050)	1.27 \pm 0.13 (0.050 \pm 0.005)	0.76 (0.030)	1.80 (0.071)
B	3.81 (0.150)	1.27 (0.050)	1.27 (0.050)	1.27 \pm 0.13 (0.050 \pm 0.005)	0.76 (0.030)	1.65 (0.065)
C	5.08 (0.200)	1.27 (0.050)	1.27 (0.050)	1.27 \pm 0.13 (0.050 \pm 0.005)	0.76 (0.030)	2.92 (0.115)
D	3.81 (0.150)	2.54 (0.100)	1.27 (0.050)	2.41 \pm 0.13/-0.25 (0.095 \pm 0.005/-0.010)	0.76 (0.030)	1.65 (0.065)
E	5.08 (0.200)	2.54 (0.100)	1.27 (0.050)	2.41 \pm 0.13/-0.25 (0.095 \pm 0.005/-0.010)	0.76 (0.030)	2.92 (0.115)
F	5.59 (0.220)	3.43 (0.135)	1.78 (0.070)	3.30 \pm 0.13 (0.130 \pm 0.005)	0.76 (0.030)	3.43 (0.135)
G	6.73 (0.265)	2.79 (0.110)	2.79 (0.110)	2.67 \pm 0.13 (0.105 \pm 0.005)	1.27 (0.050)	3.56 (0.140)
H	7.24 (0.285)	3.81 (0.150)	2.79 (0.110)	3.68 \pm 0.13/-0.51 (0.145 \pm 0.005/-0.020)	1.27 (0.050)	0.70 (0.028)
X	6.93 Max (0.273)	5.41 Max (0.213)	2.74 Max (0.108)	3.05 \pm 0.13 (0.120 \pm 0.005)	1.19 (0.047)	N/A

HOW TO ORDER

TAZ	H	227	*	006	C		#@	0^	++
Type	Case Size	Capacitance Code	Capacitance Tolerance	Voltage Code	Standard or Low ESR Range	Packaging	Qualification/Reliability	Termination Finish	Surge Test Option
		pF code: 1st two digits represent significant figures 3rd digit represents multiplier (number of zeros to follow)	M = $\pm 20\%$ K = $\pm 10\%$ J = $\pm 5\%$	004 = 4Vdc 006 = 6Vdc 010 = 10Vdc 015 = 15Vdc 020 = 20Vdc 025 = 25Vdc 035 = 35Vdc 050 = 50Vdc	C = Std ESR L = Low ESR	B = Bulk R = 7" T&R S = 13" T&R	# = Inspection Level S = Std. Conformance L = Group A @ = Failure Rate Level Weibull: B = 0.1%/1000 hrs. (90% C = 0.01%/1000 hrs. conf.) Comm: Z = Non ER	09 = Gold Plated 08 = Hot Solder Dipped 00 = Solder Fused	00 = None 23 = 10 cycles, +25°C 24 = 10 cycles, -55°C & +85°C 45 = 10 cycles, -55°C & +85°C before Weibull

TECHNICAL SPECIFICATIONS

Technical Data:	Unless otherwise specified, all technical data relate to an ambient temperature of 25°C									
Capacitance Range:	0.1 μ F to 470 μ F									
Capacitance Tolerance:	$\pm 5\%$; $\pm 10\%$; $\pm 20\%$									
Rated Voltage: (V _R)	$\leq 85^\circ\text{C}$:	4	6	10	15	20	25	35	50	
Category Voltage: (V _C)	125°C:	2.7	4	7	10	13	17	23	33	
Surge Voltage: (V _S)	$\leq 85^\circ\text{C}$:	5.2	8	13	20	26	32	46	65	
	125°C:	3.4	5	8	12	16	20	28	40	
Temperature Range:	-55°C to +125°C									



TAZ Series



COTS-Plus

CAPACITANCE AND RATED VOLTAGE, V_R (VOLTAGE CODE) RANGE (LETTER DENOTES CASE SIZE)

Capacitance		Rated voltage DC (V_R) at 85°C							
μF	Code	4V (C)	6V (D)	10V (F)	15V (H)	20V (J)	25V (K)	35V (M)	50V (N)
0.10	104								A
0.15	154								A
0.22	224							A	B
0.33	334						A	A	B
0.47	474					A	A	B	C
0.68	684				A	A/B	B	C	D
1.0	105			A	A	A/B	B/C	D	E
1.5	155		A		A/B	B/C	D	E	F
2.2	225	A		A/B	A/C	B/D	D/E		F
3.3	335	A	A/B	A/C	B/D	D/E	E	F	G
4.7	475	A/B	A/C	B/C/D	B/C/D/E	E	F	G	H
6.8	685	A/C	B/D	B/C/D/E	D/E	E/F	F/G	G/H	
10	106	B/D	B/E	B/C/D/E	D/E/F	E/F	G	H	
15	156	B/E	B/D/E	D/E/F	E/F	F/G	G/H	X	
22	226	B/D	D/E/F	E	F/G	G/H	G/H/X		
33	336	D/E/F	E	F/G	F/G/H	H	H/X		
47	476	E	F/G	F/G/H	G/H	H/X			
68	686	E/G	F/G/H	G	G/H				
100	107	F/H	G	G/H	H				
150	157	G	G	H/X					
220	227	G	H	H					
330	337	H	H						
470	447	H							

NOTE: TAZ Standard Range ratings are also available in CWR09 Military parts.



TAZ Series



COTS-Plus

Part Number	Case Size	Cap (nom) (μF)	DC rated voltage (85°C) (volts)	ESR (max) 100 kHz +25°C (ohms)	DC Leakage (max)			Dissipation Factor (max)		
					+25°C (μA)	+85°C (μA)	+125°C (μA)	+25°C (%)	+85/125°C (%)	-55°C (%)
TAZA225*004C□#@0^++	A	2.2	4	8	1	10	12	6	8	8
TAZA225*004L□#@0^++	A	2.2	4	4	1	10	12	6	8	8
TAZA335*004C□#@0^++	A	3.3	4	12	1	10	12	6	8	8
TAZA335*004L□#@0^++	A	3.3	4	6	1	10	12	6	8	8
TAZA475*004C□#@0^++	A	4.7	4	12	1	10	12	6	8	8
TAZA475*004L□#@0^++	A	4.7	4	6	1	10	12	6	8	8
TAZB475*004C□#@0^++	B	4.7	4	8	1	10	12	6	8	8
TAZB475*004L□#@0^++	B	4.7	4	3.2	1	10	12	6	8	8
TAZA685*004C□#@0^++	A	6.8	4	12	1	10	12	6	8	8
TAZA685*004L□#@0^++	A	6.8	4	6	1	10	12	6	8	8
TAZC685*004C□#@0^++	C	6.8	4	5.5	1	10	12	6	8	8
TAZC685*004L□#@0^++	C	6.8	4	5.5	1	10	12	6	8	8
TAZC685*004L□#@0^++	C	6.8	4	2.2	1	10	12	6	8	8
TAZB106*004C□#@0^++	B	10	4	8	1	10	12	8	10	10
TAZB106*004L□#@0^++	B	10	4	3.2	1	10	12	8	10	10
TAZD106*004C□#@0^++	D	10	4	4	1	10	12	8	8	10
TAZD106*004L□#@0^++	D	10	4	1.3	1	10	12	8	8	10
TAZB156*004C□#@0^++	B	15	4	8	1	10	12	8	10	10
TAZB156*004L□#@0^++	B	15	4	3.2	1	10	12	8	10	10
TAZE156*004C□#@0^++	E	15	4	3.5	1	10	12	8	10	12
TAZE156*004L□#@0^++	E	15	4	1	1	10	12	8	10	12
TAZB226*004C□#@0^++	B	22	4	8	1	10	12	8	10	10
TAZB226*004L□#@0^++	B	22	4	3.2	1	10	12	8	10	10
TAZD226*004C□#@0^++	D	22	4	4	1	10	12	8	10	12
TAZD226*004L□#@0^++	D	22	4	1.3	1	10	12	8	10	12
TAZD336*004C□#@0^++	D	33	4	4	2	20	24	8	10	12
TAZD336*004L□#@0^++	D	33	4	1.3	2	20	24	8	10	12
TAZE336*004C□#@0^++	E	33	4	3	2	20	24	8	10	12
TAZE336*004L□#@0^++	E	33	4	0.9	2	20	24	8	10	12
TAZF336*004C□#@0^++	F	33	4	2.2	2	20	24	8	10	12
TAZF336*004L□#@0^++	F	33	4	0.6	2	20	24	8	10	12
TAZE476*004C□#@0^++	E	47	4	3	2	20	24	8	10	12
TAZE476*004L□#@0^++	E	47	4	0.9	2	20	24	8	10	12
TAZE686*004C□#@0^++	E	68	4	3	3	30	36	8	10	12
TAZE686*004L□#@0^++	E	68	4	0.9	3	30	36	8	10	12
TAZG686*004C□#@0^++	G	68	4	1.1	3	30	36	10	12	12
TAZG686*004L□#@0^++	G	68	4	0.275	3	30	36	10	12	12
TAZF107*004C□#@0^++	F	100	4	2	4	40	48	10	12	12
TAZF107*004L□#@0^++	F	100	4	0.55	4	40	48	10	12	12
TAZH107*004C□#@0^++	H	100	4	0.9	4	40	48	10	12	12
TAZH107*004L□#@0^++	H	100	4	0.18	4	40	48	10	12	12
TAZG157*004C□#@0^++	G	150	4	1	6	60	72	10	12	12
TAZG157*004L□#@0^++	G	150	4	0.25	6	60	72	10	12	12
TAZH227*004C□#@0^++	H	220	4	1	8	80	96	10	12	12
TAZH227*004L□#@0^++	H	220	4	0.2	8	80	96	10	12	12

Following the voltage code, C designates Standard, L designates Low ESR Ratings



TAZ Series



COTS-Plus

Part Number	Case Size	Cap (nom) (μF)	DC rated voltage (85°C) (volts)	ESR (max) 100 kHz +25°C (ohms)	DC Leakage (max)			Dissipation Factor (max)		
					+25°C (μA)	+85°C (μA)	+125°C (μA)	+25°C (%)	+85/125°C (%)	-55°C (%)
TAZH337*004C□#@0^++	H	330	4	0.9	10	100	120	10	12	12
TAZH337*004L□#@0^++	H	330	4	0.18	10	100	120	10	12	12
TAZH477*004L□#@0^++	H	470	4	0.9	19	190	228	10	12	12
TAZA155*006C□#@0^++	A	1.5	6	8	1	10	12	6	8	8
TAZA155*006L□#@0^++	A	1.5	6	4	1	10	12	6	8	8
TAZA335*006C□#@0^++	A	3.3	6	12	1	10	12	6	8	8
TAZA335*006L□#@0^++	A	3.3	6	6	1	10	12	6	8	8
TAZB335*006C□#@0^++	B	3.3	6	8	1	10	12	6	8	8
TAZB335*006L□#@0^++	B	3.3	6	3.2	1	10	12	6	8	8
TAZA475*006C□#@0^++	A	4.7	6	12	1	10	12	6	8	8
TAZA475*006L□#@0^++	A	4.7	6	6	1	10	12	6	8	8
TAZC475*006C□#@0^++	C	4.7	6	5.5	1	10	12	6	8	8
TAZC475*006L□#@0^++	C	4.7	6	5.5	1	10	12	6	8	8
TAZC475*006L□#@0^++	C	4.7	6	2.2	1	10	12	6	8	8
TAZB685*006C□#@0^++	B	6.8	6	8	1	10	12	6	8	8
TAZB685*006L□#@0^++	B	6.8	6	3.2	1	10	12	6	8	8
TAZD685*006C□#@0^++	D	6.8	6	4.5	1	10	12	6	8	8
TAZD685*006L□#@0^++	D	6.8	6	1.5	1	10	12	6	8	8
TAZB106*006C□#@0^++	B	10	6	8	1	10	12	6	8	8
TAZB106*006L□#@0^++	B	10	6	3.2	1	10	12	6	8	8
TAZE106*006C□#@0^++	E	10	6	3.5	1	10	12	8	10	12
TAZE106*006L□#@0^++	E	10	6	1	1	10	12	8	10	12
TAZB156*006C□#@0^++	B	15	6	8	1	10	12	8	10	10
TAZB156*006L□#@0^++	B	15	6	3.2	1	10	12	8	10	10
TAZD156*006C□#@0^++	D	15	6	5	1	10	12	8	10	12
TAZD156*006L□#@0^++	D	15	6	1.7	1	10	12	8	10	12
TAZE156*006C□#@0^++	E	15	6	3	1	10	12	8	10	12
TAZE156*006L□#@0^++	E	15	6	0.9	1	10	12	8	10	12
TAZD226*006C□#@0^++	D	22	6	5	1	10	12	6	8	8
TAZD226*006L□#@0^++	D	22	6	1.7	1	10	12	6	8	8
TAZE226*006C□#@0^++	E	22	6	3.5	2	20	24	8	10	12
TAZE226*006L□#@0^++	E	22	6	1	2	20	24	8	10	12
TAZF226*006C□#@0^++	F	22	6	2.2	2	20	24	8	10	12
TAZF226*006L□#@0^++	F	22	6	0.6	2	20	24	8	10	12
TAZE336*006C□#@0^++	E	33	6	3.5	2	20	24	6	8	8
TAZE336*006L□#@0^++	E	33	6	1	2	20	24	6	8	8
TAZF476*006C□#@0^++	F	47	6	3.5	3	30	36	8	10	12
TAZF476*006L□#@0^++	F	47	6	1	3	30	36	8	10	12
TAZG476*006C□#@0^++	G	47	6	1.1	3	30	36	10	12	12
TAZG476*006L□#@0^++	G	47	6	0.275	3	30	36	10	12	12
TAZF686*006C□#@0^++	F	68	6	1.5	4	40	48	10	12	12
TAZF686*006L□#@0^++	F	68	6	0.4	4	40	48	10	12	12
TAZG686*006C□#@0^++	G	68	6	1	4	40	48	10	12	12
TAZG686*006L□#@0^++	G	68	6	0.25	4	40	48	10	12	12
TAZH686*006C□#@0^++	H	68	6	0.9	4	40	48	10	12	12

Following the voltage code, C designates Standard, L designates Low ESR Ratings



TAZ Series



COTS-Plus

Part Number	Case Size	Cap (nom) (μF)	DC rated voltage (85°C) (volts)	ESR (max) 100 kHz +25°C (ohms)	DC Leakage (max)			Dissipation Factor (max)		
					+25°C (μA)	+85°C (μA)	+125°C (μA)	+25°C (%)	+85/125°C (%)	-55°C (%)
TAZH686*006L□#@0^++	H	68	6	0.18	4	40	48	10	12	12
TAZG107*006C□#@0^++	G	100	6	1.1	6	60	72	10	12	12
TAZG107*006L□#@0^++	G	100	6	0.275	6	60	72	10	12	12
TAZG157*006C□#@0^++	G	150	6	1.1	10	100	120	10	12	12
TAZG157*006L□#@0^++	G	150	6	0.275	10	100	120	10	12	12
TAZH227*006C□#@0^++	H	220	6	0.9	10	100	120	10	12	12
TAZH227*006L□#@0^++	H	220	6	0.18	10	100	120	10	12	12
TAZH337*006C□#@0^++	H	330	6	0.9	20	200	240	10	12	12
TAZH337*006L□#@0^++	H	330	6	0.18	20	200	240	10	12	12
TAZA105*010C□#@0^++	A	1	10	10	1	10	12	6	8	8
TAZA105*010L□#@0^++	A	1	10	5	1	10	12	6	8	8
TAZA225*010C□#@0^++	A	2.2	10	12	1	10	12	6	8	8
TAZA225*010L□#@0^++	A	2.2	10	6	1	10	12	6	8	8
TAZB225*010C□#@0^++	B	2.2	10	8	1	10	12	6	8	8
TAZB225*010L□#@0^++	B	2.2	10	3.2	1	10	12	6	8	8
TAZA335*010C□#@0^++	A	3.3	10	12	1	10	12	6	8	8
TAZA335*010L□#@0^++	A	3.3	10	6	1	10	12	6	8	8
TAZC335*010C□#@0^++	C	3.3	10	5.5	1	10	12	6	8	8
TAZC335*010L□#@0^++	C	3.3	10	5.5	1	10	12	6	8	8
TAZC335*010L□#@0^++	C	3.3	10	2.2	1	10	12	6	8	8
TAZB475*010C□#@0^++	B	4.7	10	8	1	10	12	6	8	8
TAZB475*010L□#@0^++	B	4.7	10	3.2	1	10	12	6	8	8
TAZC475*010C□#@0^++	C	4.7	10	5.5	1	10	12	6	8	8
TAZC475*010L□#@0^++	C	4.7	10	2.2	1	10	12	6	8	8
TAZD475*010C□#@0^++	D	4.7	10	4.5	1	10	12	6	8	8
TAZD475*010L□#@0^++	D	4.7	10	1.5	1	10	12	6	8	8
TAZB685*010C□#@0^++	B	6.8	10	8	1	10	12	6	8	8
TAZB685*010L□#@0^++	B	6.8	10	3.2	1	10	12	6	8	8
TAZC685*010C□#@0^++	C	6.8	10	5.5	1	10	12	6	8	8
TAZC685*010L□#@0^++	C	6.8	10	2.2	1	10	12	6	8	8
TAZD685*010C□#@0^++	D	6.8	10	5	1	10	12	6	8	8
TAZD685*010L□#@0^++	D	6.8	10	1.7	1	10	12	6	8	8
TAZE685*010C□#@0^++	E	6.8	10	3.5	1	10	12	6	8	8
TAZE685*010L□#@0^++	E	6.8	10	1	1	10	12	6	8	8
TAZB106*010C□#@0^++	B	10	10	8	1	10	12	8	10	10
TAZB106*010L□#@0^++	B	10	10	3.2	1	10	12	8	10	10
TAZC106*010C□#@0^++	C	10	10	5.5	1	10	12	6	8	8
TAZC106*010L□#@0^++	C	10	10	2.2	1	10	12	6	8	8
TAZD106*010C□#@0^++	D	10	10	4	1	10	12	6	8	8
TAZD106*010L□#@0^++	D	10	10	1.3	1	10	12	6	8	8
TAZE106*010C□#@0^++	E	10	10	3.5	1	10	12	6	8	8
TAZE106*010L□#@0^++	E	10	10	1	1	10	12	6	8	8
TAZD156*010C□#@0^++	D	15	10	5	2	20	24	6	8	8
TAZD156*010L□#@0^++	D	15	10	1.7	2	20	24	6	8	8
TAZE156*010C□#@0^++	E	15	10	3	2	20	24	8	10	10

Following the voltage code, C designates Standard, L designates Low ESR Ratings



TAZ Series



COTS-Plus

Part Number	Case Size	Cap (nom) (µF)	DC rated voltage (85°C) (volts)	ESR (max) 100 kHz +25°C (ohms)	DC Leakage (max)			Dissipation Factor (max)		
					+25°C (µA)	+85°C (µA)	+125°C (µA)	+25°C (%)	+85/125°C (%)	-55°C (%)
TAZE156*010L□#@0^++	E	15	10	0.9	2	20	24	8	10	10
TAZF156*010C□#@0^++	F	15	10	2.5	2	20	24	8	8	10
TAZF156*010L□#@0^++	F	15	10	0.7	2	20	24	8	8	10
TAZE226*010C□#@0^++	E	22	10	2	3	30	36	8	10	10
TAZE226*010L□#@0^++	E	22	10	0.6	3	30	36	8	10	10
TAZF336*010C□#@0^++	F	33	10	1.5	3	30	36	8	10	10
TAZF336*010L□#@0^++	F	33	10	0.4	3	30	36	8	10	10
TAZG336*010C□#@0^++	G	33	10	1.1	3	30	36	10	12	12
TAZG336*010L□#@0^++	G	33	10	0.275	3	30	36	10	12	12
TAZF476*010C□#@0^++	F	47	10	1.5	4	40	48	10	12	12
TAZF476*010L□#@0^++	F	47	10	0.4	4	40	48	10	12	12
TAZG476*010C□#@0^++	G	47	10	1	4	40	48	10	12	12
TAZG476*010L□#@0^++	G	47	10	0.25	4	40	48	10	12	12
TAZH476*010C□#@0^++	H	47	10	0.9	5	50	60	10	12	12
TAZH476*010L□#@0^++	H	47	10	0.18	5	50	60	10	12	12
TAZG686*010C□#@0^++	G	68	10	1.1	6	60	72	10	12	12
TAZG686*010L□#@0^++	G	68	10	0.275	6	60	72	10	12	12
TAZG107*010C□#@0^++	G	100	10	1.1	10	100	120	10	12	12
TAZG107*010L□#@0^++	G	100	10	0.275	10	100	120	10	12	12
TAZH107*010C□#@0^++	H	100	10	0.9	10	100	120	10	12	12
TAZH107*010L□#@0^++	H	100	10	0.18	10	100	120	10	12	12
TAZH157*010C□#@0^++	H	150	10	0.9	15	150	180	10	12	12
TAZH157*010L□#@0^++	H	150	10	0.18	15	150	180	10	12	12
TAZX157*010C□#@0^++	X	150	10	0.9	15	150	180	10	12	12
TAZX157*010L□#@0^++	X	150	10	0.065	15	150	180	10	12	12
TAZH227*010C□#@0^++	H	220	10	0.9	20	200	240	10	12	12
TAZH227*010L□#@0^++	H	220	10	0.18	20	200	240	10	12	12
TAZA684*015C□#@0^++	A	0.68	15	12	1	10	12	6	8	8
TAZA684*015L□#@0^++	A	0.68	15	6	1	10	12	6	8	8
TAZA105*015L□#@0^++	A	1	15	7.5	1	10	12	6	8	8
TAZA155*015C□#@0^++	A	1.5	15	15	1	10	12	6	8	8
TAZA155*015L□#@0^++	A	1.5	15	7.5	1	10	12	6	8	8
TAZB155*015C□#@0^++	B	1.5	15	8	1	10	12	6	8	8
TAZB155*015L□#@0^++	B	1.5	15	3.2	1	10	12	6	8	8
TAZA225*015C□#@0^++	A	2.2	15	15	1	10	12	6	8	8
TAZA225*015L□#@0^++	A	2.2	15	7.5	1	10	12	6	8	8
TAZC225*015C□#@0^++	C	2.2	15	5.5	1	10	12	6	8	8
TAZC225*015L□#@0^++	C	2.2	15	5.5	1	10	12	6	8	8
TAZC225*015L□#@0^++	C	2.2	15	2.2	1	10	12	6	8	8
TAZB335*015C□#@0^++	B	3.3	15	9	1	10	12	6	8	8
TAZB335*015L□#@0^++	B	3.3	15	3.6	1	10	12	6	8	8
TAZD335*015C□#@0^++	D	3.3	15	5	1	10	12	6	8	8
TAZD335*015L□#@0^++	D	3.3	15	1.7	1	10	12	6	8	8
TAZB475*015C□#@0^++	B	4.7	15	5	1	10	12	6	8	8
TAZB475*015L□#@0^++	B	4.7	15	2	1	10	12	6	8	8

Following the voltage code, C designates Standard, L designates Low ESR Ratings



TAZ Series



COTS-Plus

Part Number	Case Size	Cap (nom) (μF)	DC rated voltage (85°C) (volts)	ESR (max) 100 kHz +25°C (ohms)	DC Leakage (max)			Dissipation Factor (max)		
					+25°C (μA)	+85°C (μA)	+125°C (μA)	+25°C (%)	+85/125°C (%)	-55°C (%)
TAZC475*015C□#@0^++	C	4.7	15	5.5	1	10	12	6	8	8
TAZC475*015L□#@0^++	C	4.7	15	2.2	1	10	12	6	8	8
TAZD475*015C□#@0^++	D	4.7	15	6	1	10	12	6	8	8
TAZD475*015L□#@0^++	D	4.7	15	2	1	10	12	6	8	8
TAZE475*015C□#@0^++	E	4.7	15	4	1	10	12	6	8	8
TAZE475*015L□#@0^++	E	4.7	15	1.2	1	10	12	6	8	8
TAZD685*015C□#@0^++	D	6.8	15	6	1	10	12	6	8	8
TAZD685*015L□#@0^++	D	6.8	15	2	1	10	12	6	8	8
TAZE685*015C□#@0^++	E	6.8	15	3	1	10	12	8	10	12
TAZE685*015L□#@0^++	E	6.8	15	0.9	1	10	12	8	10	12
TAZD106*015C□#@0^++	D	10	15	6	2	20	24	6	8	8
TAZD106*015L□#@0^++	D	10	15	2	2	20	24	6	8	8
TAZE106*015C□#@0^++	E	10	15	4	2	20	24	6	8	8
TAZE106*015L□#@0^++	E	10	15	1.2	2	20	24	6	8	8
TAZF106*015C□#@0^++	F	10	15	2.5	2	20	24	6	8	8
TAZF106*015L□#@0^++	F	10	15	0.667	2	20	24	6	8	8
TAZE156*015C□#@0^++	E	15	15	4	2	20	24	6	8	8
TAZE156*015L□#@0^++	E	15	15	1.2	2	20	24	6	8	8
TAZF156*015C□#@0^++	F	15	15	3	2	20	24	8	10	10
TAZF156*015L□#@0^++	F	15	15	0.8	2	20	24	8	10	10
TAZF226*015C□#@0^++	F	22	15	3	3	30	36	8	10	10
TAZF226*015L□#@0^++	F	22	15	0.8	3	30	36	8	10	10
TAZG226*015C□#@0^++	G	22	15	1.1	4	40	48	6	8	8
TAZG226*015L□#@0^++	G	22	15	0.275	4	40	48	6	8	8
TAZF336*015C□#@0^++	F	33	15	3	5	50	60	6	8	8
TAZF336*015L□#@0^++	F	33	15	0.8	5	50	60	6	8	8
TAZG336*015C□#@0^++	G	33	15	1.1	6	60	72	8	10	10
TAZG336*015L□#@0^++	G	33	15	0.275	6	60	72	8	10	10
TAZH336*015C□#@0^++	H	33	15	0.9	5	50	60	8	8	10
TAZH336*015L□#@0^++	H	33	15	0.18	5	50	60	8	8	10
TAZG476*015C□#@0^++	G	47	15	1.1	10	100	120	8	10	10
TAZG476*015L□#@0^++	G	47	15	0.275	10	100	120	8	10	10
TAZH476*015C□#@0^++	H	47	15	0.9	10	100	120	8	10	10
TAZH476*015L□#@0^++	H	47	15	0.18	10	100	120	8	10	10
TAZG686*015C□#@0^++	G	68	15	1.1	10	100	120	8	10	10
TAZG686*015L□#@0^++	G	68	15	0.275	10	100	120	8	10	10
TAZH686*015C□#@0^++	H	68	15	0.9	10	100	120	8	10	10
TAZH686*015L□#@0^++	H	68	15	0.18	10	100	120	8	10	10
TAZH107*015C□#@0^++	H	100	15	0.9	15	150	180	10	12	12
TAZH107*015L□#@0^++	H	100	15	0.18	15	150	180	10	12	12
TAZA474*020C□#@0^++	A	0.47	20	14	1	10	12	8	10	10
TAZA474*020L□#@0^++	A	0.47	20	7.5	1	10	12	8	8	10
TAZA684*020C□#@0^++	A	0.68	20	15	1	10	12	6	8	8
TAZA684*020L□#@0^++	A	0.68	20	7.5	1	10	12	6	8	8
TAZB684*020C□#@0^++	B	0.68	20	10	1	10	12	6	8	8

Following the voltage code, C designates Standard, L designates Low ESR Ratings



TAZ Series



COTS-Plus

Part Number	Case Size	Cap (nom) (µF)	DC rated voltage (85°C) (volts)	ESR (max) 100 kHz +25°C (ohms)	DC Leakage (max)			Dissipation Factor (max)		
					+25°C (µA)	+85°C (µA)	+125°C (µA)	+25°C (%)	+85/125°C (%)	-55°C (%)
TAZB684*020L□#@0^++	B	0.68	20	5.6	1	10	12	6	8	8
TAZA105*020C□#@0^++	A	1	20	15	1	10	12	6	8	8
TAZA105*020L□#@0^++	A	1	20	7.5	1	10	12	6	8	8
TAZB105*020C□#@0^++	B	1	20	12	1	10	12	6	8	8
TAZB105*020L□#@0^++	B	1	20	4.8	1	10	12	6	8	8
TAZB155*020C□#@0^++	B	1.5	20	9	1	10	12	6	8	8
TAZB155*020L□#@0^++	B	1.5	20	3.6	1	10	12	6	8	8
TAZC155*020C□#@0^++	C	1.5	20	6	1	10	12	6	8	8
TAZC155*020L□#@0^++	C	1.5	20	6	1	10	12	6	8	8
TAZC155*020L□#@0^++	C	1.5	20	2.4	1	10	12	6	8	8
TAZB225*020C□#@0^++	B	2.2	20	9	1	10	12	6	8	8
TAZB225*020L□#@0^++	B	2.2	20	3.6	1	10	12	6	8	8
TAZD225*020C□#@0^++	D	2.2	20	5	1	10	12	6	8	8
TAZD225*020L□#@0^++	D	2.2	20	1.7	1	10	12	6	8	8
TAZD335*020C□#@0^++	D	3.3	20	6	1	10	12	6	8	8
TAZD335*020L□#@0^++	D	3.3	20	2	1	10	12	6	8	8
TAZE335*020C□#@0^++	E	3.3	20	4	1	10	12	6	8	8
TAZE335*020L□#@0^++	E	3.3	20	1.2	1	10	12	6	8	8
TAZE475*020C□#@0^++	E	4.7	20	6	1	10	12	6	8	8
TAZE475*020L□#@0^++	E	4.7	20	1.7	1	10	12	6	8	8
TAZE685*020C□#@0^++	E	6.8	20	5	2	20	24	6	8	8
TAZE685*020L□#@0^++	E	6.8	20	1.5	2	20	24	6	8	8
TAZF685*020C□#@0^++	F	6.8	20	2.4	2	20	24	6	8	8
TAZF685*020L□#@0^++	F	6.8	20	0.7	2	20	24	6	8	8
TAZE106*020C□#@0^++	E	10	20	5	2	20	24	6	8	8
TAZE106*020L□#@0^++	E	10	20	1.5	2	20	24	6	8	8
TAZF106*020C□#@0^++	F	10	20	3	2	20	24	6	8	8
TAZF106*020L□#@0^++	F	10	20	0.8	2	20	24	6	8	8
TAZF156*020C□#@0^++	F	15	20	3	3	30	36	6	8	8
TAZF156*020L□#@0^++	F	15	20	0.8	3	30	36	6	8	8
TAZG156*020C□#@0^++	G	15	20	1.1	3	30	36	6	8	8
TAZG156*020L□#@0^++	G	15	20	0.275	3	30	36	6	8	8
TAZG226*020C□#@0^++	G	22	20	2.5	4	40	48	6	8	8
TAZG226*020L□#@0^++	G	22	20	0.625	4	40	48	6	8	8
TAZH226*020C□#@0^++	H	22	20	0.9	4	40	48	6	8	8
TAZH226*020L□#@0^++	H	22	20	0.18	4	40	48	6	8	8
TAZH336*020C□#@0^++	H	33	20	0.9	6	60	72	8	10	10
TAZH336*020L□#@0^++	H	33	20	0.18	6	60	72	8	10	10
TAZH476*020C□#@0^++	H	47	20	0.9	10	100	120	8	10	10
TAZH476*020L□#@0^++	H	47	20	0.18	10	100	120	8	10	10
TAZX476*020C□#@0^++	X	47	20	0.9	10	100	120	8	10	10
TAZX476*020L□#@0^++	X	47	20	0.11	10	100	120	8	10	10
TAZA334*025C□#@0^++	A	0.33	25	15	1	10	12	6	8	8
TAZA334*025L□#@0^++	A	0.33	25	7.5	1	10	12	6	8	8
TAZA474*025C□#@0^++	A	0.47	25	15	1	10	12	6	8	8

Following the voltage code, C designates Standard, L designates Low ESR Ratings



TAZ Series



COTS-Plus

Part Number	Case Size	Cap (nom) (μF)	DC rated voltage (85°C) (volts)	ESR (max) 100 kHz +25°C (ohms)	DC Leakage (max)			Dissipation Factor (max)		
					+25°C (μA)	+85°C (μA)	+125°C (μA)	+25°C (%)	+85/125°C (%)	-55°C (%)
TAZA474*025L□#@0^++	A	0.47	25	7.5	1	10	12	6	8	8
TAZB684*025C□#@0^++	B	0.68	25	7.5	1	10	12	6	8	8
TAZB684*025L□#@0^++	B	0.68	25	4	1	10	12	6	8	8
TAZB105*025C□#@0^++	B	1	25	10	1	10	12	6	8	8
TAZB105*025L□#@0^++	B	1	25	4	1	10	12	6	8	8
TAZC105*025C□#@0^++	C	1	25	6.5	1	10	12	6	8	8
TAZC105*025L□#@0^++	C	1	25	6.5	1	10	12	6	8	8
TAZC105*025L□#@0^++	C	1	25	2.6	1	10	12	6	8	8
TAZD155*025C□#@0^++	D	1.5	25	6.5	1	10	12	6	8	8
TAZD155*025L□#@0^++	D	1.5	25	1.7	1	10	12	6	8	8
TAZD225*025C□#@0^++	D	2.2	25	6	1	10	12	6	8	8
TAZD225*025L□#@0^++	D	2.2	25	2	1	10	12	6	8	8
TAZE225*025C□#@0^++	E	2.2	25	3.5	1	10	12	6	8	8
TAZE225*025L□#@0^++	E	2.2	25	1	1	10	12	6	8	8
TAZE335*025C□#@0^++	E	3.3	25	4	1	10	12	6	8	8
TAZE335*025L□#@0^++	E	3.3	25	1.2	1	10	12	6	8	8
TAZF475*025C□#@0^++	F	4.7	25	2.5	2	20	24	6	8	8
TAZF475*025L□#@0^++	F	4.7	25	0.7	2	20	24	6	8	8
TAZF685*025C□#@0^++	F	6.8	25	3	2	20	24	6	8	8
TAZF685*025L□#@0^++	F	6.8	25	0.8	2	20	24	6	8	8
TAZG685*025C□#@0^++	G	6.8	25	1.2	2	20	24	6	8	8
TAZG685*025L□#@0^++	G	6.8	25	0.3	2	20	24	6	8	8
TAZG106*025C□#@0^++	G	10	25	1.4	3	30	36	6	8	8
TAZG106*025L□#@0^++	G	10	25	0.35	3	30	36	6	8	8
TAZG156*025C□#@0^++	G	15	25	1.4	4	40	48	6	8	8
TAZG156*025L□#@0^++	G	15	25	0.35	4	40	48	6	8	8
TAZH156*025C□#@0^++	H	15	25	1	4	40	48	6	8	8
TAZH156*025L□#@0^++	H	15	25	0.2	4	40	48	6	8	8
TAZG226*025C□#@0^++	G	22	25	1.4	6	60	72	6	8	8
TAZG226*025L□#@0^++	G	22	25	0.35	6	60	72	6	8	8
TAZH226*025C□#@0^++	H	22	25	0.9	6	60	72	6	8	8
TAZH226*025L□#@0^++	H	22	25	0.18	6	60	72	6	8	8
TAZX226*025C□#@0^++	X	22	25	0.9	6	60	72	6	8	8
TAZX226*025L□#@0^++	X	22	25	0.16	6	60	72	6	8	8
TAZH336*025C□#@0^++	H	33	25	0.9	10	100	120	8	10	10
TAZH336*025L□#@0^++	H	33	25	0.18	10	100	120	6	8	8
TAZX336*025L□#@0^++	X	33	25	0.13	10	100	120	8	10	10
TAZX336*025C□#@0^++	X	33	25	0.9	10	100	120	8	10	10
TAZA224*035C□#@0^++	A	0.22	35	18	1	10	12	6	8	8
TAZA224*035L□#@0^++	A	0.22	35	12	1	10	12	6	8	8
TAZA334*035C□#@0^++	A	0.33	35	22	1	10	12	6	8	8
TAZA334*035L□#@0^++	A	0.33	35	12	1	10	12	6	8	8
TAZB474*035C□#@0^++	B	0.47	35	10	1	10	12	6	8	8
TAZB474*035L□#@0^++	B	0.47	35	6.8	1	10	12	6	8	8
TAZC684*035C□#@0^++	C	0.68	35	8	1	10	12	6	8	8

Following the voltage code, C designates Standard, L designates Low ESR Ratings



TAZ Series



COTS-Plus

Part Number	Case Size	Cap (nom) (μF)	DC rated voltage (85°C) (volts)	ESR (max) 100 kHz +25°C (ohms)	DC Leakage (max)			Dissipation Factor (max)		
					+25°C (μA)	+85°C (μA)	+125°C (μA)	+25°C (%)	+85/125°C (%)	-55°C (%)
TAZC684*035C□#@0^++	C	0.68	35	10	1	10	12	6	8	8
TAZC684*035L□#@0^++	C	0.68	35	4	1	10	12	6	8	8
TAZD105*035C□#@0^++	D	1	35	6.5	1	10	12	6	8	8
TAZD105*035L□#@0^++	D	1	35	2.2	1	10	12	6	8	8
TAZE155*035C□#@0^++	E	1.5	35	4.5	1	10	12	6	8	8
TAZE155*035L□#@0^++	E	1.5	35	1.3	1	10	12	6	8	8
TAZF335*035C□#@0^++	F	3.3	35	2.5	1	10	12	6	8	8
TAZF335*035L□#@0^++	F	3.3	35	0.7	1	10	12	6	8	8
TAZG475*035C□#@0^++	G	4.7	35	1.5	2	20	24	6	8	8
TAZG475*035L□#@0^++	G	4.7	35	0.375	2	20	24	6	8	8
TAZG685*035C□#@0^++	G	6.8	35	1.5	3	30	36	6	8	8
TAZG685*035L□#@0^++	G	6.8	35	0.375	3	30	36	6	8	8
TAZH685*035C□#@0^++	H	6.8	35	1.3	3	30	36	6	8	8
TAZH685*035L□#@0^++	H	6.8	35	0.5	3	30	36	6	8	8
TAZH106*035C□#@0^++	H	10	35	0.9	4	40	48	8	10	10
TAZH106*035L□#@0^++	H	10	35	0.5	4	40	48	8	10	10
TAZX156*035C□#@0^++	X	15	35	0.9	6	60	72	6	8	8
TAZX156*035L□#@0^++	X	15	35	0.19	6	60	72	6	8	8
TAZA104*050C□#@0^++	A	0.1	50	22	1	10	12	6	8	8
TAZA104*050L□#@0^++	A	0.1	50	12	1	10	12	6	8	8
TAZA154*050C□#@0^++	A	0.15	50	17	1	10	12	6	8	8
TAZA154*050L□#@0^++	A	0.15	50	12	1	10	12	6	8	8
TAZB224*050C□#@0^++	B	0.22	50	14	1	10	12	6	8	8
TAZB224*050L□#@0^++	B	0.22	50	6.8	1	10	12	6	8	8
TAZB334*050C□#@0^++	B	0.33	50	12	1	10	12	6	8	8
TAZB334*050L□#@0^++	B	0.33	50	4.8	1	10	12	6	8	8
TAZC474*050C□#@0^++	C	0.47	50	8	1	10	12	6	8	8
TAZC474*050L□#@0^++	C	0.47	50	8	1	10	12	6	8	8
TAZC474*050L□#@0^++	C	0.47	50	3.2	1	10	12	6	8	8
TAZD684*050C□#@0^++	D	0.68	50	7	1	10	12	6	8	8
TAZD684*050L□#@0^++	D	0.68	50	2.3	1	10	12	6	8	8
TAZE105*050C□#@0^++	E	1	50	6	1	10	12	6	8	8
TAZE105*050L□#@0^++	E	1	50	1.7	1	10	12	6	8	8
TAZF155*050C□#@0^++	F	1.5	50	4	1	10	12	6	8	8
TAZF155*050L□#@0^++	F	1.5	50	1.1	1	10	12	6	8	8
TAZF225*050C□#@0^++	F	2.2	50	2.5	2	20	24	6	8	8
TAZF225*050L□#@0^++	F	2.2	50	0.7	2	20	24	6	8	8
TAZG335*050C□#@0^++	G	3.3	50	2	2	20	24	6	8	8
TAZG335*050L□#@0^++	G	3.3	50	0.5	2	20	24	6	8	8
TAZH475*050C□#@0^++	H	4.7	50	1.5	3	30	36	6	8	8
TAZH475*050L□#@0^++	H	4.7	50	0.5	3	30	36	6	8	8

Following the voltage code, C designates Standard, L designates Low ESR Ratings



TBJ Series



CWR11 - MIL-PRF-55365/8



Fully qualified to MIL-PRF-55365/8, the CWR11 is the military version of EIA-535BAAC, the commercial industry standard. It comprises four case sizes (A through D). This series also offers molded body/compliant termination construction, polarity, capacitance and JAN brand marking. The molded construction is compatible with a wide

range of SMT board assembly processes including wave or reflow solder, conductive epoxy or compression bonding techniques. There are three termination finishes available: fused solder plated ("K" per MIL-PRF-55365), hot solder dipped ("C") and gold plated ("B").

CASE DIMENSIONS: millimeters (inches)

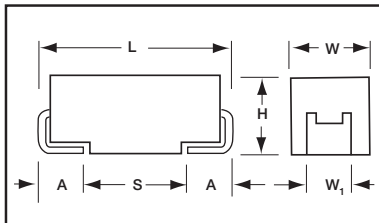

Case Code	EIA Code	Length (L)	Width (W)	Height (H)	Term. Width (W ₁) ±0.10 (±0.004)	Term. Length A ±0.30(±0.012)	S min
A	3216-18	3.20±0.20 (0.126±0.008)	1.60±0.20 (0.063±0.008)	1.60±0.20 (0.063±0.008)	1.20 (0.047)	0.80 (0.031)	1.80 (0.071)
B	3528-21	3.50±0.20 (0.138±0.008)	2.80±0.20 (0.110±0.008)	1.90±0.20 (0.075±0.008)	2.20 (0.087)	0.80 (0.031)	1.40 (0.055)
C	6032-28	6.00±0.30 (0.236±0.012)	3.20±0.30 (0.126±0.012)	2.50±0.30 (0.098±0.012)	2.20 (0.087)	1.30 (0.051)	2.90 (0.114)
D	7343-31	7.30±0.30 (0.287±0.012)	4.30±0.30 (0.169±0.012)	2.80±0.30 (0.110±0.012)	2.40 (0.094)	1.30 (0.051)	4.40 (0.173)

MARKING

(Brown marking on gold body)



Polarity Stripe (+)

"J" for "JAN" Brand
Capacitance Code

Rated Voltage
Manufacturer's ID

HOW TO ORDER

CWR11	J	B	225	*	@	+	
Type	Voltage Code C = 4Vdc D = 6Vdc F = 10Vdc H = 16Vdc J = 20Vdc K = 25Vdc M = 35Vdc N = 50Vdc	Termination Finish K = Fused Solder Plated C = Hot Solder Dipped B = Gold Plated	Capacitance Code pF code: 1st two digits represent significant figures 3rd digit represents multiplier (number of zeros to follow)	Capacitance Tolerance M = ±20% K = ±10% J = ±5%	Reliability Grade Weibull: B = 0.1%/1000 Hrs. (90% C = 0.01%/1000 Hrs. conf.) Comm: Z = Non ER	Surge Test Option A = 10 cycles, +25°C B = 10 cycles, -55°C & +85°C C = 10 cycles, -55°C & +85°C before Weibull Z = None (required for CWR19 & CWR29 only)	Packaging Bulk = Standard TR = 7" T&R TR13 = 13" T&R W = Waffle

TECHNICAL SPECIFICATIONS

Technical Data:	Unless otherwise specified, all technical data relate to an ambient temperature of 25°C									
Capacitance Range:	0.1 µF to 100 µF									
Capacitance Tolerance:	±5%; ±10%; ±20%									
Rated Voltage: (V _R)	≤85°C:	4	6	10	16	20	25	35	50	
Category Voltage: (V _C)	125°C:	2.7	4	7	10	13	17	23	33	
Surge Voltage: (V _S)	≤85°C:	5.2	8	13	20	26	32	46	65	
	125°C:	3.4	5	8	13	16	20	28	40	
Temperature Range:	-55°C to +125°C									



TBJ Series



CWR11 - MIL-PRF-55365/8

CAPACITANCE AND RATED VOLTAGE, V_R (VOLTAGE CODE) RANGE (LETTER DENOTES CASE SIZE)

Capacitance		Rated voltage DC (V_R) to 85°C							
μF	Code	4V (C)	6V (D)	10V (F)	16V (H)	20V (J)	25V (K)	35V (M)	50V (N)
0.10	104							A	A
0.15	154							A	B
0.22	224							A	B
0.33	334						A	A	B
0.47	474					A	A	B	C
0.68	684				A	A	B	B	C
1.0	105			A	A	A	B	B	C
1.5	155		A	A	A	B	B	C	D
2.2	225	A	A	A	B	B	C	C	D
3.3	335		A	B	B	B	C	C	D
4.7	475	A	B	B	B	C	C	D	D
6.8	685	B	B	B		C	D	D	
10	106	B	B		C		D		
15	156	B	C			D	D		
22	226		C		D	D			
33	336	C		D	D				
47	476		D	D					
68	686	D	D						
100	107	D							
150	157								
220	227								
330	337								



TBJ Series



CWR11 - MIL-PRF-55365/8

Part Number	Case Size	Cap (nom) (μF)	DC rated voltage (85°C) (volts)	ESR (max) 100 kHz +25°C (ohms)	DC Leakage (max)			Dissipation Factor (max)		
					+25°C (μA)	+85°C (μA)	+125°C (μA)	+25°C (%)	+85/125°C (%)	-55°C (%)
CWR11CK225*@+□	A	2.2	4	8	0.5	5	6	6	9	9
CWR11CK475*@+□	A	4.7	4	8	0.5	5	6	6	9	9
CWR11CK685*@+□	B	6.8	4	5.5	0.5	5	6	6	9	9
CWR11CK106*@+□	B	10	4	4	0.5	5	6	6	9	9
CWR11CK156*@+□	B	15	4	3.5	0.6	6	7.2	6	9	9
CWR11CK336*@+□	C	33	4	2.2	1.3	13	15.6	6	9	9
CWR11CK686*@+□	D	68	4	1.1	2.7	27	32.4	6	9	9
CWR11CK107*@+□	D	100	4	0.9	4	40	48	8	12	12
CWR11DK155*@+□	A	1.5	6	8	0.5	5	6	6	9	9
CWR11DK225*@+□	A	2.2	6	8	0.5	5	6	6	6	9
CWR11DK335*@+□	A	3.3	6	8	0.5	5	6	6	9	9
CWR11DK475*@+□	B	4.7	6	5.5	0.5	5	6	6	9	9
CWR11DK685*@+□	B	6.8	6	4.5	0.5	5	6	6	9	9
CWR11DK106*@+□	B	10	6	3.5	0.6	6	7.2	6	9	9
CWR11DK156*@+□	C	15	6	3	0.9	9	10.8	6	9	9
CWR11DK226*@+□	C	22	6	2.2	1.4	14	16.8	6	9	9
CWR11DK476*@+□	D	47	6	1.1	2.8	28	33.6	6	9	9
CWR11DK686*@+□	D	68	6	0.9	4.3	43	86	6	9	9
CWR11FK105*@+□	A	1	10	10	0.5	5	6	4	6	6
CWR11FK155*@+□	A	1.5	10	8	0.5	5	6	6	6	9
CWR11FK225*@+□	A	2.2	10	8	0.5	5	6	6	9	9
CWR11FK335*@+□	B	3.3	10	5.5	0.5	5	6	6	9	9
CWR11FK475*@+□	B	4.7	10	4.5	0.5	5	6	6	9	9
CWR11FK685*@+□	B	6.8	10	3.5	0.7	7	8.4	6	9	9
CWR11FK156*@+□	C	15	10	2.5	1.5	15	18	6	6	9
CWR11FK336*@+□	D	33	10	1.1	3.3	33	39.6	6	9	9
CWR11FK476*@+□	D	47	10	0.9	4.7	47	56.4	6	9	9
CWR11HK684*@+□	A	0.68	16	12	0.5	5	6	4	6	6
CWR11HK105*@+□	A	1	16	10	0.5	5	6	4	6	6
CWR11HK155*@+□	A	1.5	16	8	0.5	5	6	6	9	9
CWR11HK225*@+□	B	2.2	16	5	0.5	5	6	6	9	9
CWR11HK335*@+□	B	3.3	16	5	0.5	5	6	6	8	9
CWR11HK475*@+□	B	4.7	16	4	0.7	7	8.4	6	9	9
CWR11HK106*@+□	C	10	16	2.5	1.6	16	19.2	6	8	9
CWR11HK226*@+□	D	22	16	1.1	3.3	33	39.6	6	8	9
CWR11HK336*@+□	D	33	16	0.9	5.3	53	106	6	9	9
CWR11JK474*@+□	A	0.47	20	14	0.5	5	6	4	6	6
CWR11JK684*@+□	A	0.68	20	12	0.5	5	6	4	6	6
CWR11JK105*@+□	A	1	20	10	0.5	5	6	4	6	6
CWR11JK155*@+□	B	1.5	20	6	0.5	5	6	6	9	9
CWR11JK225*@+□	B	2.2	20	5	0.5	5	6	6	8	9
CWR11JK335*@+□	B	3.3	20	4	0.7	7	8.4	6	9	9
CWR11JK475*@+□	C	4.7	20	3	1	10	12	6	8	9



TBJ Series



CWR11 - MIL-PRF-55365/8

Part Number	Case Size	Cap (nom) (μF)	DC rated voltage (85°C) (volts)	ESR (max) 100 kHz +25°C (ohms)	DC Leakage (max)			Dissipation Factor (max)		
					+25°C (μA)	+85°C (μA)	+125°C (μA)	+25°C (%)	+85/125°C (%)	-55°C (%)
CWR11JK685*@+□	C	6.8	20	2.4	1.4	14	16.8	6	9	9
CWR11JK156*@+□	D	15	20	1.1	3	30	36	6	8	9
CWR11JK226*@+□	D	22	20	0.9	4.4	44	52.8	6	9	9
CWR11KK334*@+□	A	0.33	25	15	0.5	5	6	4	6	6
CWR11KK474*@+□	A	0.47	25	14	0.5	5	6	4	6	6
CWR11KK684*@+□	B	0.68	25	7.5	0.5	5	6	4	6	6
CWR11KK105*@+□	B	1	25	6.5	0.5	5	6	4	6	6
CWR11KK155*@+□	B	1.5	25	6.5	0.5	5	6	6	8	9
CWR11KK225*@+□	C	2.2	25	3.5	0.6	6	7.2	6	9	9
CWR11KK335*@+□	C	3.3	25	3.5	0.9	9	10.8	6	8	9
CWR11KK475*@+□	C	4.7	25	2.5	1.2	12	14.4	6	9	9
CWR11KK685*@+□	D	6.8	25	1.4	1.7	17	20.4	6	9	9
CWR11KK106*@+□	D	10	25	1.2	2.5	25	30	6	8	9
CWR11KK156*@+□	D	15	25	1	3.8	38	45.6	6	9	9
CWR11MK104*@+□	A	0.1	35	24	0.5	5	6	4	6	6
CWR11MK154*@+□	A	0.15	35	21	0.5	5	6	4	6	6
CWR11MK224*@+□	A	0.22	35	18	0.5	5	6	4	6	6
CWR11MK334*@+□	A	0.33	35	15	0.5	5	6	4	6	6
CWR11MK474*@+□	B	0.47	35	10	0.5	5	6	4	6	6
CWR11MK684*@+□	B	0.68	35	8	0.5	5	6	4	6	6
CWR11MK105*@+□	B	1	35	6.5	0.5	5	6	4	6	6
CWR11MK155*@+□	C	1.5	35	4.5	0.5	5	6	6	8	9
CWR11MK225*@+□	C	2.2	35	3.5	0.8	8	9.6	6	8	9
CWR11MK335*@+□	C	3.3	35	2.5	1.2	12	14.4	6	8	9
CWR11MK475*@+□	D	4.7	35	1.5	1.7	17	20.4	6	8	9
CWR11MK685*@+□	D	6.8	35	1.3	2.4	24	28.8	6	9	9
CWR11NK104*@+□	A	0.1	50	22	0.5	5	12	6	8	8
CWR11NK154*@+□	B	0.15	50	17	0.5	5	6	4	6	6
CWR11NK224*@+□	B	0.22	50	14	0.5	5	6	4	6	6
CWR11NK334*@+□	B	0.33	50	12	0.5	5	6	4	6	6
CWR11NK474*@+□	C	0.47	50	8	0.5	5	6	4	6	6
CWR11NK684*@+□	C	0.68	50	7	0.5	5	6	4	6	6
CWR11NK105*@+□	C	1	50	6	0.5	5	6	4	6	6
CWR11NK155*@+□	D	1.5	50	4	0.8	8	9.6	6	8	9
CWR11NK225*@+□	D	2.2	50	2.5	1.1	11	13.2	6	8	9
CWR11NK335*@+□	D	3.3	50	2	1.7	17	20.4	6	9	9
CWR11NK475*@+□	D	4.7	50	1.5	2.4	24	28.8	6	9	9



TBJ Series

COTS-Plus



This series features:

- CWR11 form factor in Standard and Extended ratings.
- Low ESR Ratings (Cases A through E).
- Extended Case size (E) for ratings to 470 μ F.
- Weibull Reliability Grading and Surge Test options.

All ratings in this series offer the advantages of molded body/compliant termination construction, polarity, capacitance and voltage marking. The molded construction is compatible with a wide range of SMT board assembly processes including wave or reflow solder, conductive epoxy or compression bonding techniques.

CASE DIMENSIONS: millimeters (inches)

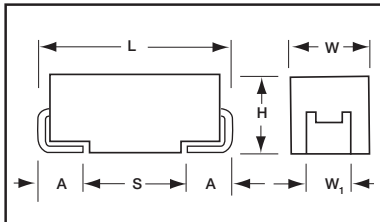

Code	EIA Code	L \pm 0.20 (0.008)	W \pm 0.20 (0.008) -0.10 (0.004)	H \pm 0.20 (0.008) -0.10 (0.004)	W ₁ \pm 0.20 (0.008)	A \pm 0.30 (0.012) -0.20 (0.008)	S Min.
A	3216-18	3.20 (0.126)	1.60 (0.063)	1.60 (0.063)	1.20 (0.047)	0.80 (0.031)	1.10 (0.043)
B	3528-21	3.50 (0.138)	2.80 (0.110)	1.90 (0.075)	2.20 (0.087)	0.80 (0.031)	1.40 (0.055)
C	6032-28	6.00 (0.236)	3.20 (0.126)	2.60 (0.102)	2.20 (0.087)	1.30 (0.051)	2.90 (0.114)
D	7343-31	7.30 (0.287)	4.30 (0.169)	2.90 (0.114)	2.40 (0.094)	1.30 (0.051)	4.40 (0.173)
E	7343-43	7.30 (0.287)	4.30 (0.169)	4.10 (0.162)	2.40 (0.094)	1.30 (0.051)	4.40 (0.173)
V	7361-38	7.30 (0.287)	6.10 (0.240)	3.45 \pm 0.30 (0.136 \pm 0.012)	3.10 (0.120)	1.40 (0.055)	4.40 (0.173)

MARKING (Military)

(Brown marking on gold body)



Polarity stripe (+)
"J" for "JAN" Brand
Capacitance Code
Rated Voltage
Manufacturer's ID

MARKING

(Brown marking on gold body)



Polarity Stripe (+)
Capacitance Code
Rated Voltage
Manufacturer's ID
Lot Number

HOW TO ORDER

TBJ	D	227	*	006	C		#@	00	++
Type	Case Size	Capacitance Code	Capacitance Tolerance	Voltage Code	Standard or Low ESR Range	Packaging	Qualification/Reliability	Termination Finish	Surge Test Option
		pF code: 1st two digits represent significant figures 3rd digit represents multiplier (number of zeros to follow)	M = \pm 20% K = \pm 10% J = \pm 5%	004 = 4Vdc 006 = 6Vdc 010 = 10Vdc 016 = 16Vdc 020 = 20Vdc 025 = 25Vdc 035 = 35Vdc 050 = 50Vdc	C = Std ESR L = Low ESR	B = Bulk R = 7" T&R S = 13" T&R	# = Inspection Level S = Std. Conformance L = Group A @ = Failure Level Weibull: B = 0.1%/1000 hrs. C = 0.01%/ 1000 hrs. (90% conf.) Comm: Z = Non ER	09 = Gold Plated 08 = Hot Solder Dipped 07 = 100% Tin 00 = Solder Fused	00 = None 23 = 10 cycles, +25°C 24 = 10 cycles, -55°C & +85°C 45 = 10 cycles, -55°C & +85°C before Weibull

TECHNICAL SPECIFICATIONS

Technical Data:	Unless otherwise specified, all technical data relate to an ambient temperature of 25°C									
Capacitance Range:	0.1 μ F to 1000 μ F									
Capacitance Tolerance:	\pm 5%; \pm 10%; \pm 20%									
Rated Voltage: (V _R)	\leq 85°C:	4	6	10	16	20	25	35	50	
Category Voltage: (V _C)	125°C:	2.7	4	7	10	13	17	23	33	
Surge Voltage: (V _S)	\leq 85°C:	5.2	8	13	20	26	32	46	65	
	125°C:	3.4	5	8	12	16	20	28	40	
Temperature Range:	-55°C to +125°C									



CAPACITANCE AND RATED VOLTAGE, V_R (VOLTAGE CODE) RANGE (LETTER DENOTES CASE SIZE)

Capacitance		Rated voltage DC (V_R) to 85°C							
μF	Code	4V (G)	6V (J)	10V (A)	16V (C)	20V (D)	25V (E)	35V (V)	50V (T)
0.10	104							A	A
0.15	154							A	A ^(M) /B
0.22	224							A	A ^(M) /B
0.33	334						A	A	B
0.47	474					A	A	A ^(M) /B	A/C
0.68	684				A	A	A/B	A ^(M) /B	A/C
1.0	105			A	A	A	A/B	A/B	A ^(M) /C
1.5	155		A	A	A	A/B	A/B	A/B/C	C/D
2.2	225	A	A	A	A/B	B	A/B/C	B/C	D
3.3	335		A	A/B	A/B	B	B/C	B/C	D
4.7	475	A	A/B	A/B	A/B	A/B/C	A/B/C	B/C/D	D
6.8	685	A/B	A/B	A/B	A/B/C	B/C	B/C/D	C/D	D
10	106	A/B	A/B	A/B/C	B/C	B/C	C/D	C/D	
15	156	A/B	A/B/C	A/B/C	B/C	B/C/D	D	C/D	D
22	226	A	A/B/C	B/C	B/C/D	C/D	C/D	D/E	V*
33	336	A/B/C	B/C	A/B/C/D	C/D	C/D	D/E	D ^(M) /V*	
47	476	B	C/D	C/D	C/D	D	D ^(M)	V*	
68	686	A/C/D	B/C/D	C/D	D	D/E	V*		
100	107	A/B/C/D	C/D	C/D	D/E	V*	V*		
150	157		D	D	D ^(M) /V*	V*			
220	227	D	C/D	D ^(M) /E	V*				
330	337	E	E	D ^(M) /E/V*					
470	477		E ^(M) /V	E ^(M) /V*					
680	687		V*						
1000	108	D/V*							
1500	158								
2200	228								

Released codes ^(M tolerance only)

*Parts are not available on C level

TBJ Series



COTS-Plus

Part Number	Case Size	DC rated voltage (85°C) (volts)	Cap (nom) (µF)	ESR (max) 100 kHz +25°C (ohms)	DC Leakage (max)			Dissipation Factor (max)		
					+25°C (µA)	+85°C (µA)	+125°C (µA)	+25°C (%)	+85/125°C (%)	-55°C (%)
TBJA225*004C□#@00++	A	4	2.2	8	0.5	5	6	6	9	9
TBJA475*004C□#@00++	A	4	4.7	8	0.5	5	6	6	9	9
TBJA685*004C□#@00++	A	4	6.8	6.5	0.5	5	10	6	9	10
TBJB685*004C□#@00++	B	4	6.8	5.5	0.5	5	6	6	9	9
TBJA106*004C□#@00++	A	4	10	6	0.5	5	10	6	9	10
TBJB106*004C□#@00++	B	4	10	4	0.5	5	6	6	9	9
TBJA156*004C□#@00++	A	4	15	4	0.6	6	12	6	9	10
TBJB156*004C□#@00++	B	4	15	3.5	0.6	6	7.2	6	9	9
TBJA226*004C□#@00++	A	4	22	3.5	0.9	9	18	6	9	10
TBJA336*004C□#@00++	A	4	33	3	1.4	14	28	6	9	9
TBJB336*004C□#@00++	B	4	33	2.8	1.4	14	28	6	9	10
TBJC336*004C□#@00++	C	4	33	2.2	1.3	13	15.6	6	9	9
TBJB476*004C□#@00++	B	4	47	2.4	1.9	19	38	6	9	10
TBJA686*004C□#@00++	A	4	68	1.5	2.7	27	32.4	10	12	14
TBJC686*004C□#@00++	C	4	68	1.6	2.7	27	54	6	9	10
TBJD686*004C□#@00++	D	4	68	1.1	2.7	27	32.4	6	9	9
TBJA107*004C□#@00++	A	4	100	1.4	4	40	48	30	36	42
TBJB107*004C□#@00++	B	4	100	1.6	4	40	80	8	10	12
TBJC107*004C□#@00++	C	4	100	1.3	4	40	80	6	9	10
TBJD107*004C□#@00++	D	4	100	0.9	4	40	48	8	12	12
TBJD227*004C□#@00++	D	4	220	0.9	8.8	88	176	8	10	12
TBJE337*004C□#@00++	E	4	330	0.9	13.2	132	264	8	10	12
TBJD108*004C□#@00++	D	4	1000	0.2	40	400	480	60	90	90
TBJA155*006C□#@00++	A	6	1.5	8	0.5	5	6	6	9	9
TBJA225*006C□#@00++	A	6	2.2	8	0.5	5	6	6	6	9
TBJA335*006C□#@00++	A	6	3.3	8	0.5	5	6	6	9	9
TBJA475*006C□#@00++	A	6	4.7	6	0.5	5	10	6	9	10
TBJB475*006C□#@00++	B	6	4.7	5.5	0.5	5	6	6	9	9
TBJA685*006C□#@00++	A	6	6.8	5	0.5	5	10	6	9	10
TBJB685*006C□#@00++	B	6	6.8	4.5	0.5	5	6	6	9	9
TBJA106*006C□#@00++	A	6	10	4	1	10	20	6	9	10
TBJB106*006C□#@00++	B	6	10	3.5	0.6	6	7.2	6	9	9
TBJA156*006C□#@00++	A	6	15	3.5	1	10	20	6	9	10
TBJA156*006L□#@00++	A	6	15	1.5	1	10	20	6	9	10
TBJB156*006C□#@00++	B	6	15	3.5	1	10	20	6	9	10
TBJC156*006C□#@00++	C	6	15	3	0.9	9	10.8	6	9	9
TBJA226*006C□#@00++	A	6	22	3	1.4	14	28	6	9	10
TBJB226*006C□#@00++	B	6	22	2.5	1.4	14	28	6	9	10
TBJC226*006C□#@00++	C	6	22	2.2	1.4	14	16.8	6	9	9
TBJB336*006C□#@00++	B	6	33	2.2	2.1	21	42	6	9	10
TBJB336*006L□#@00++	B	6	33	0.6	2.1	21	42	6	9	10
TBJC336*006C□#@00++	C	6	33	1.8	2.1	21	42	6	9	10
TBJC476*006C□#@00++	C	6	47	1.6	3	30	60	6	9	10
TBJD476*006C□#@00++	D	6	47	1.1	2.8	28	33.6	6	9	9
TBJB686*006C□#@00++	B	6	68	1.8	4.3	43	86	8	10	12
TBJC686*006C□#@00++	C	6	68	1.6	4.3	43	86	6	9	10
TBJD686*006C□#@00++	D	6	68	0.9	4.3	43	86	6	9	9
TBJC107*006C□#@00++	C	6	100	0.9	6.3	63	126	6	9	10

Following the voltage code, C designates Standard, L designates Low ESR Ratings



TBJ Series

COTS-Plus



Part Number	Case Size	DC rated voltage (85°C) (volts)	Cap (nom) (µF)	ESR (max) 100 kHz +25°C (ohms)	DC Leakage (max)			Dissipation Factor (max)		
					+25°C (µA)	+85°C (µA)	+125°C (µA)	+25°C (%)	+85/125°C (%)	-55°C (%)
TBJC107*006L□#@00++	C	6	100	0.15	6.3	63	126	6	9	10
TBJD107*006C□#@00++	D	6	100	0.9	6.3	63	126	6	9	10
TBJD157*006C□#@00++	D	6	150	0.9	9.5	95	190	6	9	10
TBJC227*006C□#@00++	C	6	220	1.2	13.9	139	278	10	12	14
TBJD227*006C□#@00++	D	6	220	0.9	13.9	139	278	8	10	12
TBJD227*006L□#@00++	D	6	220	0.1	13.9	139	278	8	10	12
TBJE337*006C□#@00++	E	6	330	0.9	19.8	198	396	8	10	12
TBJE337*006L□#@00++	E	6	330	0.1	20.8	208	416	8	10	12
TBJE477M006C□#@00++	E	6	470	0.9	29.6	296	592	10	12	14
TBJE477M006L□#@00++	E	6	470	0.05	29.6	296	592	10	12	14
TBJV477*006L□#@00++	V	6	470	0.1	29.6	296	592	10	12	12
TBJA105*010C□#@00++	A	10	1	10	0.5	5	6	4	6	6
TBJA155*010C□#@00++	A	10	1.5	8	0.5	5	6	6	6	9
TBJA225*010C□#@00++	A	10	2.2	8	0.5	5	6	6	9	9
TBJA335*010C□#@00++	A	10	3.3	5.5	0.5	5	10	6	9	10
TBJB335*010C□#@00++	B	10	3.3	5.5	0.5	5	6	6	9	9
TBJA475*010C□#@00++	A	10	4.7	5	0.5	5	10	6	9	10
TBJB475*010C□#@00++	B	10	4.7	4.5	0.5	5	6	6	9	9
TBJA685*010C□#@00++	A	10	6.8	4	0.7	7	14	6	9	10
TBJB685*010C□#@00++	B	10	6.8	3.5	0.7	7	8.4	6	9	9
TBJA106*010C□#@00++	A	10	10	3	1	10	20	6	9	10
TBJA106*010L□#@00++	A	10	10	1.8	1	10	20	6	9	10
TBJB106*010C□#@00++	B	10	10	2.5	1	10	20	6	9	10
TBJC106*010C□#@00++	C	10	10	2.5	1	10	20	6	9	10
TBJA156*010C□#@00++	A	10	15	3.2	1.6	16	32	6	9	10
TBJB156*010C□#@00++	B	10	15	2.8	1.6	16	32	6	9	10
TBJC156*010C□#@00++	C	10	15	2.5	1.5	15	18	6	6	9
TBJB226*010C□#@00++	B	10	22	2.4	2.2	22	44	6	9	10
TBJB226*010L□#@00++	B	10	22	0.7	2.2	22	44	6	9	10
TBJC226*010C□#@00++	C	10	22	1	2.2	22	44	6	9	10
TBJA336*010C□#@00++	A	10	33	1.7	3.3	33	39.6	8	10	12
TBJB336*010C□#@00++	B	10	33	1.8	3.3	33	66	6	9	10
TBJC336*010C□#@00++	C	10	33	1.6	3.3	33	66	6	9	10
TBJD336*010C□#@00++	D	10	33	1.1	3.3	33	39.6	6	9	9
TBJC476*010C□#@00++	C	10	47	1.2	4.7	47	94	6	9	10
TBJD476*010C□#@00++	D	10	47	0.9	4.7	47	56.4	6	9	9
TBJC686*010C□#@00++	C	10	68	1.2	6.8	68	136	8	10	12
TBJD686*010C□#@00++	D	10	68	0.9	6.8	68	136	6	9	10
TBJC107*010C□#@00++	C	10	100	1.2	10	100	200	8	10	12
TBJC107*010L□#@00++	C	10	100	0.2	10	100	200	8	10	12
TBJD107*010C□#@00++	D	10	100	0.9	10	100	200	6	9	10
TBJD107*010L□#@00++	D	10	100	0.1	10	100	200	6	9	10
TBJD157*010C□#@00++	D	10	150	0.9	15	150	300	8	10	12
TBJD157*010L□#@00++	D	10	150	0.1	15	150	300	8	10	12
TBJD227M010C□#@00++	D	10	220	0.9	22	220	440	8	10	12
TBJD227M010L□#@00++	D	10	220	0.15	22	220	440	8	10	12

Following the voltage code, C designates Standard, L designates Low ESR Ratings



TBJ Series



COTS-Plus

Part Number	Case Size	DC rated voltage (85°C) (volts)	Cap (nom) (µF)	ESR (max) 100 kHz +25°C (ohms)	DC Leakage (max)			Dissipation Factor (max)		
					+25°C (µA)	+85°C (µA)	+125°C (µA)	+25°C (%)	+85/125°C (%)	-55°C (%)
TBJE227*010C□#@00++	E	10	220	0.9	22	220	440	8	10	12
TBJE227*010L□#@00++	E	10	220	0.1	22	220	440	8	10	12
TBJD337M010C□#@00++	D	10	330	0.9	33	330	660	8	10	12
TBJD337M010L□#@00++	D	10	330	0.15	33	330	660	8	10	12
TBJE337*010C□#@00++	E	10	330	0.9	33	330	660	8	10	12
TBJE337*010L□#@00++	E	10	330	0.06	33	330	660	8	10	12
TBJV337*010L□#@00++	V	10	330	0.1	33	330	660	8	10	12
TBJE477M010C□#@00++	E	10	470	0.9	47	470	940	10	12	14
TBJE477M010L□#@00++	E	10	470	0.05	47	470	940	10	12	14
TBJV477*010L□#@00++	V	10	470	0.1	47	470	940	10	12	14
TBJA684*015C□#@00++	A	16	0.68	12	0.5	5	6	4	6	6
TBJA105*015C□#@00++	A	16	1	10	0.5	5	6	4	6	6
TBJA155*015C□#@00++	A	16	1.5	8	0.5	5	6	6	9	9
TBJA225*015C□#@00++	A	16	2.2	5.5	0.5	5	10	6	9	10
TBJB225*015C□#@00++	B	16	2.2	5	0.5	5	6	6	9	9
TBJA335*015C□#@00++	A	16	3.3	5	0.5	5	10	6	9	10
TBJA335*015L□#@00++	A	16	3.3	3.5	0.5	5	10	6	9	10
TBJB335*015C□#@00++	B	16	3.3	5	0.5	5	6	6	8	9
TBJA475*015C□#@00++	A	16	4.7	4	0.8	8	16	6	9	10
TBJB475*015C□#@00++	B	16	4.7	4	0.7	7	8.4	6	9	9
TBJA685*015C□#@00++	A	16	6.8	2.5	1.1	11	22	6	9	10
TBJB685*015C□#@00++	B	16	6.8	2.5	1.1	11	22	6	9	10
TBJC685*015C□#@00++	C	16	6.8	2.5	1.1	11	22	6	9	10
TBJB106*015C□#@00++	B	16	10	2.8	1.6	16	32	6	9	10
TBJC106*015C□#@00++	C	16	10	2.5	1.6	16	19.2	6	8	9
TBJB156*015C□#@00++	B	16	15	2.5	2.4	24	48	6	9	10
TBJB156*015L□#@00++	B	16	15	0.8	2.4	24	48	6	9	10
TBJC156*015C□#@00++	C	16	15	1.8	2.4	24	48	6	9	10
TBJB226*015C□#@00++	B	16	22	2.3	3.6	36	72	6	9	10
TBJC226*015C□#@00++	C	16	22	1.6	3.6	36	72	6	9	10
TBJC226*015L□#@00++	C	16	22	0.375	3.6	36	72	6	9	10
TBJD226*015C□#@00++	D	16	22	1.1	3.3	33	39.6	6	8	9
TBJC336*015C□#@00++	C	16	33	1.5	5.3	53	106	6	9	10
TBJC336*015L□#@00++	C	16	33	0.3	5.3	53	106	6	9	10
TBJD336*015C□#@00++	D	16	33	0.9	5.3	53	106	6	9	9
TBJC476*015C□#@00++	C	16	47	1.5	7.6	76	152	6	9	10
TBJC476*015L□#@00++	C	16	47	0.35	7.6	76	152	6	9	10
TBJD476*015C□#@00++	D	16	47	0.9	7.6	76	152	6	9	10
TBJD476*015L□#@00++	D	16	47	0.15	7.6	76	152	6	9	10
TBJD686*015C□#@00++	D	16	68	0.9	10.9	109	218	6	9	10
TBJD107*015C□#@00++	D	16	100	0.9	16	160	320	6	9	10
TBJD107*015L□#@00++	D	16	100	0.125	16	160	320	6	9	10
TBJE107*015C□#@00++	E	16	100	0.9	16	160	320	6	9	10
TBJE107*015L□#@00++	E	16	100	0.1	16	160	320	6	9	10
TBJD157M015C□#@00++	D	16	150	0.9	24	240	480	6	9	10

Following the voltage code, C designates Standard, L designates Low ESR Ratings



TBJ Series



COTS-Plus

Part Number	Case Size	DC rated voltage (85°C) (volts)	Cap (nom) (µF)	ESR (max) 100 kHz +25°C (ohms)	DC Leakage (max)			Dissipation Factor (max)		
					+25°C (µA)	+85°C (µA)	+125°C (µA)	+25°C (%)	+85/125°C (%)	-55°C (%)
TBJD157M015L□#@00++	D	16	150	0.15	24	240	480	6	9	10
TBJV157*015L□#@00++	V	16	150	0.045	24	480	960	6	8	10
TBJV227*015L□#@00++	V	16	220	0.15	35.2	352	704	8	10	12
TBJA474*020C□#@00++	A	20	0.47	14	0.5	5	6	4	6	6
TBJA684*020C□#@00++	A	20	0.68	12	0.5	5	6	4	6	6
TBJA105*020C□#@00++	A	20	1	10	0.5	5	6	4	6	6
TBJA155*020C□#@00++	A	20	1.5	6.5	0.5	5	10	6	8	10
TBJB155*020C□#@00++	B	20	1.5	6	0.5	5	6	6	9	9
TBJB225*020C□#@00++	B	20	2.2	5	0.5	5	6	6	8	9
TBJB335*020C□#@00++	B	20	3.3	4	0.7	7	8.4	6	9	9
TBJA475*020C□#@00++	A	20	4.7	4	1	10	20	6	8	10
TBJA475*020L□#@00++	A	20	4.7	1.8	1	10	20	6	8	10
TBJB475*020C□#@00++	B	20	4.7	3	2	20	40	6	8	10
TBJC475*020C□#@00++	C	20	4.7	3	1	10	12	6	8	9
TBJB685*020C□#@00++	B	20	6.8	2.5	1.4	14	28	6	8	10
TBJC685*020C□#@00++	C	20	6.8	2.4	1.4	14	16.8	6	9	9
TBJB106*020C□#@00++	B	20	10	2.1	0.7	7	14	6	8	10
TBJB106*020L□#@00++	B	20	10	1	0.7	7	14	6	8	10
TBJC106*020C□#@00++	C	20	10	1.9	1.4	14	28	6	8	10
TBJB156*020C□#@00++	B	20	15	2	3	30	60	6	8	10
TBJC156*020C□#@00++	C	20	15	1.7	3	30	60	6	8	10
TBJD156*020C□#@00++	D	20	15	1.1	3	30	36	6	8	9
TBJC226*020C□#@00++	C	20	22	1.6	4.4	44	88	6	8	10
TBJD226*020C□#@00++	D	20	22	0.9	4.4	44	52.8	6	9	9
TBJC336*020C□#@00++	C	20	33	1.5	6.6	66	132	6	8	10
TBJD336*020C□#@00++	D	20	33	0.9	6.6	66	132	6	8	10
TBJD336*020L□#@00++	D	20	33	0.2	6.6	66	132	6	8	10
TBJD476*020C□#@00++	D	20	47	0.9	9.4	94	188	6	8	10
TBJD686*020C□#@00++	D	20	68	0.9	13.6	136	272	6	8	10
TBJE686*020C□#@00++	E	20	68	0.9	13.6	136	272	6	8	10
TBJE686*020L□#@00++	E	20	68	0.15	13.6	136	272	6	8	10
TBJV107*020L□#@00++	V	20	100	0.2	20	200	400	8	10	12
TBJA334*025C□#@00++	A	25	0.33	15	0.5	5	6	4	6	6
TBJA474*025C□#@00++	A	25	0.47	14	0.5	5	6	4	6	6
TBJA684M025C□#@00++	A	25	0.68	10	0.5	5	10	4	6	8
TBJB684*025C□#@00++	B	25	0.68	7.5	0.5	5	6	4	6	6
TBJA105*025C□#@00++	A	25	1	8	0.5	5	10	4	6	8
TBJB105*025C□#@00++	B	25	1	6.5	0.5	5	6	4	6	6
TBJA155*025C□#@00++	A	25	1.5	7.5	0.5	5	10	6	8	10
TBJA155*025L□#@00++	A	25	1.5	3	0.5	5	10	6	8	10
TBJB155*025C□#@00++	B	25	1.5	6.5	0.5	5	6	6	8	9
TBJA225*025C□#@00++	A	25	2.2	7	0.5	5	10	6	8	10
TBJB225*025C□#@00++	B	25	2.2	4.5	0.5	5	10	6	8	10
TBJC225*025C□#@00++	C	25	2.2	3.5	0.6	6	7.2	6	9	9
TBJB335*025C□#@00++	B	25	3.3	3.5	0.5	5	10	6	8	10

Following the voltage code, C designates Standard, L designates Low ESR Ratings



TBJ Series



COTS-Plus

Part Number	Case Size	DC rated voltage (85°C) (volts)	Cap (nom) (µF)	ESR (max) 100 kHz +25°C (ohms)	DC Leakage (max)			Dissipation Factor (max)		
					+25°C (µA)	+85°C (µA)	+125°C (µA)	+25°C (%)	+85/125°C (%)	-55°C (%)
TBJC335*025C□#@00++	C	25	3.3	3.5	0.9	9	10.8	6	8	9
TBJA475*025C□#@00++	A	25	4.7	3.1	1.2	12	14.4	6	9	10
TBJB475*025C□#@00++	B	25	4.7	2.8	1.2	12	24	6	8	10
TBJB475*025L□#@00++	B	25	4.7	1.5	1.2	12	24	6	8	10
TBJC475*025C□#@00++	C	25	4.7	2.5	1.2	12	14.4	6	9	9
TBJB685*025C□#@00++	B	25	6.8	2.8	1.7	17	34	6	8	10
TBJC685*025C□#@00++	C	25	6.8	2	1.7	17	34	6	8	10
TBJD685*025C□#@00++	D	25	6.8	1.4	1.7	17	20.4	6	9	9
TBJC106*025C□#@00++	C	25	10	1.8	2.5	25	50	6	8	10
TBJC106*025L□#@00++	C	25	10	0.5	2.5	25	50	6	8	10
TBJD106*025C□#@00++	D	25	10	1.2	2.5	25	30	6	8	9
TBJD156*025C□#@00++	D	25	15	1	3.8	38	45.6	6	9	9
TBJC226*025C□#@00++	C	25	22	1.4	5.5	55	110	6	8	10
TBJD226*025C□#@00++	D	25	22	0.9	5.5	55	110	6	8	10
TBJD226*025L□#@00++	D	25	22	0.2	5.5	55	110	6	8	10
TBJD336*025C□#@00++	D	25	33	0.9	8.3	83	166	6	8	10
TBJE336*025C□#@00++	E	25	33	0.9	8.3	83	166	6	8	10
TBJE336*025L□#@00++	E	25	33	0.3	8.3	83	166	6	8	10
TBJD476M025C□#@00++	D	25	47	0.9	11.8	118	236	6	8	10
TBJD476M025L□#@00++	D	25	47	0.25	11.8	118	236	6	8	10
TBJV686*025L□#@00++	V	25	68	0.15	17	170	340	8	10	12
TBJA104*035C□#@00++	A	35	0.1	24	0.5	5	6	4	6	6
TBJA154*035C□#@00++	A	35	0.15	21	0.5	5	6	4	6	6
TBJA224*035C□#@00++	A	35	0.22	18	0.5	5	6	4	6	6
TBJA334*035C□#@00++	A	35	0.33	15	0.5	5	6	4	6	6
TBJA474M035C□#@00++	A	35	0.47	12	0.5	5	10	4	6	8
TBJB474*035C□#@00++	B	35	0.47	10	0.5	5	6	4	6	6
TBJA684M035C□#@00++	A	35	0.68	8	0.5	5	10	4	6	8
TBJB684*035C□#@00++	B	35	0.68	8	0.5	5	6	4	6	6
TBJA105*035C□#@00++	A	35	1	7.5	0.5	5	10	4	6	6
TBJB105*035C□#@00++	B	35	1	6.5	0.5	5	6	4	6	6
TBJA155*035C□#@00++	A	35	1.5	7.5	0.5	5	10	6	8	9
TBJB155*035C□#@00++	B	35	1.5	5.2	0.5	5	10	6	8	9
TBJC155*035C□#@00++	C	35	1.5	4.5	0.5	5	6	6	8	9
TBJB225*035C□#@00++	B	35	2.2	4.2	0.8	8	16	6	8	9
TBJC225*035C□#@00++	C	35	2.2	3.5	0.8	8	9.6	6	8	9
TBJB335*035C□#@00++	B	35	3.3	3.5	1.2	12	24	6	8	9
TBJC335*035C□#@00++	C	35	3.3	2.5	1.2	12	14.4	6	8	9
TBJB475*035C□#@00++	B	35	4.7	3.1	1.6	16	32	6	8	9
TBJC475*035C□#@00++	C	35	4.7	2.2	1.6	16	32	6	8	9
TBJC475*035L□#@00++	C	35	4.7	0.6	1.6	16	32	6	8	9
TBJD475*035C□#@00++	D	35	4.7	1.5	1.7	17	20.4	6	8	9
TBJC685*035C□#@00++	C	35	6.8	1.8	2.4	24	48	6	9	9
TBJD685*035C□#@00++	D	35	6.8	1.3	2.4	24	28.8	6	9	9
TBJC106*035C□#@00++	C	35	10	1.6	3.5	35	70	6	9	9
TBJD106*035C□#@00++	D	35	10	1	3.5	35	70	6	9	9

Following the voltage code, C designates Standard, L designates Low ESR Ratings



TBJ Series

COTS-Plus



Part Number	Case Size	DC rated voltage (85°C) (volts)	Cap (nom) (μF)	ESR (max) 100 kHz +25°C (ohms)	DC Leakage (max)			Dissipation Factor (max)		
					+25°C (μA)	+85°C (μA)	+125°C (μA)	+25°C (%)	+85/125°C (%)	-55°C (%)
TBJD106*035L□#@00++	D	35	10	0.3	3.5	35	70	6	9	9
TBJC156*035C□#@00++	C	35	15	1.4	5.3	53	106	6	9	9
TBJD156*035C□#@00++	D	35	15	0.9	5.3	53	106	6	9	9
TBJD156*035L□#@00++	D	35	15	0.3	5.3	53	106	6	9	9
TBJD226*035C□#@00++	D	35	22	0.9	7.7	77	154	6	9	9
TBJD226*035L□#@00++	D	35	22	0.4	7.7	77	154	6	9	9
TBJE226*035C□#@00++	E	35	22	0.9	7.7	77	154	6	9	9
TBJE226*035L□#@00++	E	35	22	0.3	7.7	77	154	6	9	9
TBJD336M035C□#@00++	D	35	33	0.9	11.6	116	232	6	9	9
TBJD336M035L□#@00++	D	35	33	0.3	11.6	116	232	6	9	9
TBJA104*050C□#@00++	A	50	0.1	22	0.5	5	12	6	8	8
TBJA154M050C□#@00++	A	50	0.15	21	0.5	5	10	4	6	6
TBJB154*050C□#@00++	B	50	0.15	17	0.5	5	6	4	6	6
TBJA224M050C□#@00++	A	50	0.22	18	0.5	5	10	4	6	6
TBJB224*050C□#@00++	B	50	0.22	14	0.5	5	6	4	6	6
TBJB334*050C□#@00++	B	50	0.33	12	0.5	5	6	4	6	6
TBJA474*050C□#@00++	A	50	0.47	9.5	0.5	5	6	4	6	6
TBJC474*050C□#@00++	C	50	0.47	8	0.5	5	6	4	6	6
TBJA684*050C□#@00++	A	50	0.68	7.9	0.5	5	6	4	6	6
TBJC684*050C□#@00++	C	50	0.68	7	0.5	5	6	4	6	6
TBJA105M050C□#@00++	A	50	1	6.6	0.5	5	6	4	6	6
TBJC105*050C□#@00++	C	50	1	6	0.5	5	6	4	6	6
TBJC155*050C□#@00++	C	50	1.5	5	0.8	8	16	6	8	9
TBJD155*050C□#@00++	D	50	1.5	4	0.8	8	9.6	6	8	9
TBJD225*050C□#@00++	D	50	2.2	2.5	1.1	11	13.2	6	8	9
TBJD335*050C□#@00++	D	50	3.3	2	1.7	17	20.4	6	9	9
TBJD475*050C□#@00++	D	50	4.7	1.5	2.4	24	28.8	6	9	9
TBJD685*050C□#@00++	D	50	6.8	1	3.4	34	68	6	6	6
TBJD156*050C□#@00++	D	50	15	0.6	7.5	75	90	4	6	6

Following the voltage code, C designates Standard, L designates Low ESR Ratings



SRC9000 Series



High Reliability Tantalum Capacitors for Space Applications



AVX SRC9000 microminiature capacitors are designed and built to meet the high reliability and long term requirements of military space applications. All SRC9000 capacitors meet all of the requirements of Mil-PRF-55365 and include DPA requirements per MIL-STD-1580. SRC9000 establishes a rigorous screening test schedule designed to detect and eliminate from

shipment any capacitor or capacitor test lots that exhibits poor performance or reliability. SRC9000 establishes a continuous test schedule to determine baseline reliability data for specific product shipped under this specification. SRC9000 assures that proper lot control and lot traceability procedures are in effect.

CASE DIMENSIONS: millimeters (inches)

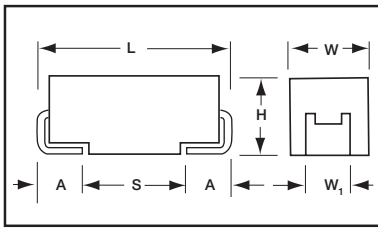

Case Code	Type	Length (L)	Width (W)	Height (H)	Term. Width (W1)	Term. Length (A)	S min
A	TAZ	2.54±0.38 (0.100±0.015)	1.27±0.38 (0.050±0.015)	1.27±0.38 (0.050±0.015)	1.27±0.13 (0.050±0.005)	0.76±0.13 (0.030±0.005)	1.80 (0.071)
	TBJ	3.20±0.20 (0.126±0.008)	1.60 ^{+0.20} _{-0.10} (0.063 ^{+0.008} _{-0.004})	1.60 ^{+0.20} _{-0.10} (0.063 ^{+0.008} _{-0.004})	1.20±0.20 (0.047±0.008)	0.80 ^{+0.30} _{-0.20} (0.031 ^{+0.012} _{-0.008})	1.80 (0.071)
B	TAZ	3.81±0.38 (0.150±0.015)	1.27±0.38 (0.050±0.015)	1.27±0.38 (0.050±0.015)	1.27±0.13 (0.050±0.005)	0.76±0.13 (0.030±0.005)	1.65 (0.065)
	TBJ	3.50±0.20 (0.138±0.008)	2.80 ^{+0.20} _{-0.10} (0.110 ^{+0.008} _{-0.004})	1.90 ^{+0.20} _{-0.10} (0.075 ^{+0.008} _{-0.004})	2.20±0.20 (0.087±0.008)	0.80 ^{+0.30} _{-0.20} (0.031 ^{+0.012} _{-0.008})	1.40 (0.055)
C	TAZ	5.08±0.38 (0.200±0.015)	1.27±0.38 (0.050±0.015)	1.27±0.38 (0.050±0.015)	1.27±0.13 (0.050±0.005)	0.76±0.13 (0.030±0.005)	2.92 (0.115)
	TBJ	6.00±0.20 (0.236±0.008)	3.20 ^{+0.20} _{-0.10} (0.126 ^{+0.008} _{-0.004})	2.60 ^{+0.20} _{-0.10} (0.102 ^{+0.008} _{-0.004})	2.20±0.20 (0.087±0.008)	1.30 ^{+0.30} _{-0.20} (0.051 ^{+0.012} _{-0.008})	2.90 (0.114)
D	TAZ	3.81±0.38 (0.150±0.015)	2.54±0.38 (0.100±0.015)	1.27±0.38 (0.050±0.015)	2.41 ^{+0.13} _{-0.25} (0.095 ^{+0.005} _{-0.010})	0.76±0.13 (0.030±0.005)	1.65 (0.065)
	TBJ	7.30±0.20 (0.287±0.008)	4.30 ^{+0.20} _{-0.10} (0.169 ^{+0.008} _{-0.004})	2.90 ^{+0.20} _{-0.10} (0.114 ^{+0.008} _{-0.004})	2.40±0.20 (0.094±0.008)	1.30 ^{+0.30} _{-0.20} (0.051 ^{+0.012} _{-0.008})	4.40 (0.173)
E	TAZ	5.08±0.38 (0.200±0.015)	2.54±0.38 (0.100±0.015)	1.27±0.38 (0.050±0.015)	2.41 ^{+0.13} _{-0.25} (0.095 ^{+0.005} _{-0.010})	0.76±0.13 (0.030±0.005)	2.92 (0.115)
	TBJ	7.30±0.20 (0.287±0.008)	4.30 ^{+0.20} _{-0.10} (0.169 ^{+0.008} _{-0.004})	4.10 ^{+0.20} _{-0.10} (0.162 ^{+0.008} _{-0.004})	2.40±0.20 (0.094±0.008)	1.30 ^{+0.30} _{-0.20} (0.051 ^{+0.012} _{-0.008})	4.40 (0.173)
F	TAZ	5.59±0.38 (0.220±0.015)	3.43±0.38 (0.135±0.015)	1.78±0.38 (0.070±0.015)	3.30±0.13 (0.130±0.005)	0.76±0.13 (0.030±0.005)	3.43 (0.135)
G	TAZ	6.73±0.38 (0.265±0.015)	2.79±0.38 (0.110±0.015)	2.79±0.38 (0.110±0.015)	2.67±0.13 (0.105±0.005)	1.27±0.13 (0.050±0.005)	3.56 (0.140)
H	TAZ	7.24±0.38 (0.285±0.015)	3.81±0.38 (0.150±0.015)	2.79±0.38 (0.110±0.015)	3.68 ^{+0.13} _{-0.51} (0.145 ^{+0.005} _{-0.020})	1.27±0.13 (0.050±0.005)	0.70 (0.028)
V	TBJ	7.30±0.20 (0.287±0.008)	6.10 ^{+0.20} _{-0.10} (0.240 ^{+0.008} _{-0.004})	3.45±0.30 (0.136±0.012)	3.10±0.20 (0.120±0.008)	1.40 ^{+0.30} _{-0.20} (0.055 ^{+0.012} _{-0.008})	1.80 (0.071)
X	TAZ	6.93 Max (0.273)	5.41 Max (0.213)	2.74 Max (0.108)	3.05±0.13 (0.120±0.005)	1.19 (0.047)	N/A

HOW TO ORDER

D	227	*	006	C	#@	90	++		
Type (3 letters) TBJ TAZ	Case Size	Capacitance Code	Capacitance Tolerance M = ±20% K = ±10% J = ±5%	Voltage Code 004 = 4Vdc 006 = 6Vdc 010 = 10Vdc 015 = 15Vdc 020 = 20Vdc 025 = 25Vdc 035 = 35Vdc 050 = 50Vdc	Standard or Low ESR Range C = Std ESR L = Low ESR	Packaging B = Bulk R = 7" T&R S = 13" T&R	Qualification/ Reliability # = Inspection Level S = Std. Conformance L = Group A @ = Failure Rate Level Weibull: B = 0.1%/1000 hrs. (90% C = 0.01%/ 1000 hrs. conf.) Comm: Z = Non ER	Termination Finish 90 = SRC9000	Surge Test Option 00 = None 23 = 10 cycles, +25°C 24 = 10 cycles, -55°C & +85°C 45 = 10 cycles, -55°C & +85°C before Weibull



SRC9000 Series



High Reliability Tantalum Capacitors for Space Applications

TECHNICAL SPECIFICATIONS

Technical Data:	Unless otherwise specified, all technical data relate to an ambient temperature of 25°C									
Capacitance Range:	0.1 μ F to 470 μ F									
Capacitance Tolerance:	\pm 5%; \pm 10%; \pm 20%									
Rated Voltage: (V_R)	\leq 85°C:	4	6	10	15	20	25	35	50	
Category Voltage: (V_C)	125°C:	2.7	4	7	10	13	17	23	33	
Surge Voltage: (V_S)	\leq 85°C:	5.2	8	13	20	26	32	46	65	
	125°C:	3.4	5	8	13	16	20	28	40	
Temperature Range:	-55°C to +125°C									

CAPACITANCE AND RATED VOLTAGE, V_R (VOLTAGE CODE) RANGE (LETTER DENOTES CASE SIZE)

Capacitance		Voltage Rating DC (V_R) to 85°C															
μ F	Code	4V		6V		10V		15V		20V		25V		35V		50V	
		TAZ	TBJ	TAZ	TBJ	TAZ	TBJ	TAZ	TBJ	TAZ	TBJ	TAZ	TBJ	TAZ	TBJ	TAZ	TBJ
0.1	104														A	A	A
0.15	154														A	A	A ^(M) /B
0.22	224													A	A	B	A ^(M) /B
0.33	334											A	A	A	A	B	B
0.47	474									A	A	A	A	B	A ^(M) /B	C	C
0.68	684							A	A	A/B	A	B	A/B	C	A ^(M) /B	D	C
1	105					A	A	A	A	A/B	A	B/C	A/B	D	A/B	E	C
1.5	155			A	A	A	A	A/B	A	B/C	A/B	D	A/B	E	A/B/C	F	C/D
2.2	225	A	A	A	A	A/B	A	A/C	A/B	B/D	B	D/E	A/B/C		B/C	F	D
3.3	335	A		A/B	A	A/C	A/B	B/D	A/B	D/E	B	E	B/C	F	B/C	G	D
4.7	475	A/B	A	A/C	A/B	B/C/D	A/B	B/C/D/E	A/B	E	A/B/C	F	B/C	G	B/C/D	H	D
6.8	685	A/C	A/B	B/D	A/B	B/C/D/E	A/B	D/E	A/B/C	E/F	B/C	F/G	B/C/D	G/H	C/D		D
10	106	B/D	A/B	B/E	A/B	B/C/D/E	A/B/C	D/E/F	B/C	E/F	B/C	G	C/D	H	C/D		
15	156	B/E	A/B	B/D/E	A/B/C	D/E/F	A/B/C	E/F	B/C	F/G	B/C/D	G/H	D	X	C/D		
22	226	B/D	A	D/E/F	A/B/C	E	B/C	F/G	B/C/D	G/H	C/D	G/H/X	C/D		D/E		
33	336	D/E/F	A/B/C	E	B/C	F/G	B/C/D	F/G/H	C/D	H	C/D	H/X	D/E		D ^(M)		
47	476	E	B	F/G	C/D	F/G/H	C/D	G/H	C/D	H/X	D		D ^(M)				
68	686	E/G	C/D	F/G/H	B/C/D	G	C/D	G/H	D		D/E		V				
100	107	F/H	B/C/D	G	C/D	G/H	C/D	H	D/E		V						
150	157	G		G	D	H/X	D		D ^(M) /V								
220	227	G	D	H	C/D	H	D ^(M) /E		V								
330	337	H	E	H	E		D ^(M) /E										
470	477	H			E ^(M) /V		E ^(M) /V										
680	687																



SRC9000 Series



High Reliability Tantalum Capacitors for Space Applications

Part Number	Case Size	Cap (nom) (μF)	DC rated voltage (85°C) (volts)	ESR (max) 100 kHz +25°C (ohms)	DC Leakage (max)			Dissipation Factor (max)		
					+25°C (μA)	+85°C (μA)	+125°C (μA)	+25°C (%)	+85/125°C (%)	-55°C (%)
TAZA225*004L□#@90++	A	2.2	4	4	1	10	12	6	8	8
TBJA225*004C□#@90++	A	2.2	4	8	0.5	5	6	6	9	9
TAZA335*004L□#@90++	A	3.3	4	6	1	10	12	6	8	8
TAZA475*004L□#@90++	A	4.7	4	6	1	10	12	6	8	8
TBJA475*004C□#@90++	A	4.7	4	8	0.5	5	6	6	9	9
TAZB475*004L□#@90++	B	4.7	4	3.2	1	10	12	6	8	8
TAZA685*004L□#@90++	A	6.8	4	6	1	10	12	6	8	8
TBJA685*004C□#@90++	A	6.8	4	6.5	0.5	5	10	6	9	10
TBJB685*004C□#@90++	B	6.8	4	5.5	0.5	5	6	6	9	9
TAZC685*004L□#@90++	C	6.8	4	2.2	1	10	12	6	8	8
TBJA106*004C□#@90++	A	10	4	6	0.5	5	10	6	9	10
TAZB106*004L□#@90++	B	10	4	3.2	1	10	12	8	10	10
TBJB106*004C□#@90++	B	10	4	4	0.5	5	6	6	9	9
TAZD106*004L□#@90++	D	10	4	1.3	1	10	12	8	8	10
TBJA156*004C□#@90++	A	15	4	4	0.6	6	12	6	9	10
TAZB156*004L□#@90++	B	15	4	3.2	1	10	12	8	10	10
TBJB156*004C□#@90++	B	15	4	3.5	0.6	6	7.2	6	9	9
TAZE156*004L□#@90++	E	15	4	1	1	10	12	8	10	12
TBJA226*004C□#@90++	A	22	4	3.5	0.9	9	18	6	9	10
TAZB226*004L□#@90++	B	22	4	3.2	1	10	12	8	10	10
TAZD226*004L□#@90++	D	22	4	1.3	1	10	12	8	10	12
TBJA336*004C□#@90++	A	33	4	3	1.4	14	28	6	9	9
TBJB336*004C□#@90++	B	33	4	2.8	1.4	14	28	6	9	10
TBJC336*004C□#@90++	C	33	4	2.2	1.3	13	15.6	6	9	9
TBJB476*004C□#@90++	B	47	4	2.4	1.9	19	38	6	9	10
TBJC686*004C□#@90++	C	68	4	1.6	2.7	27	54	6	9	10
TBJD686*004C□#@90++	D	68	4	1.1	2.7	27	32.4	6	9	9
TBJB107*004C□#@90++	B	100	4	1.6	4	40	80	8	10	12
TBJC107*004C□#@90++	C	100	4	1.3	4	40	80	6	9	10
TBJD107*004C□#@90++	D	100	4	0.9	4	40	48	8	12	12
TAZH107*004L□#@90++	H	100	4	0.18	4	40	48	10	12	12
TAZG157*004L□#@90++	G	150	4	0.25	6	60	72	10	12	12
TBJD227*004C□#@90++	D	220	4	0.9	8.8	88	176	8	10	12
TAZG227*004L□#@90++	G	220	4	0.2	8	80	96	10	12	12
TBJE337*004C□#@90++	E	330	4	0.9	13.2	132	264	8	10	12
TAZH337*004L□#@90++	L	330	4	0.18	10	100	120	10	12	12
TAZA155*006L□#@90++	A	1.5	6	4	1	10	12	6	8	8
TBJA155*006C□#@90++	A	1.5	6	8	0.5	5	6	6	9	9
TBJA225*006C□#@90++	A	2.2	6	8	0.5	5	6	6	6	9
TBJA335*006C□#@90++	A	3.3	6	8	0.5	5	6	6	9	9
TAZA335*006L□#@90++	A	3.3	6	6	1	10	12	6	8	8
TAZB335*006L□#@90++	B	3.3	6	3.2	1	10	12	6	8	8
TBJA475*006C□#@90++	A	4.7	6	6	0.5	5	10	6	9	10
TAZA475*006L□#@90++	A	4.7	6	6	1	10	12	6	8	8
TBJB475*006C□#@90++	B	4.7	6	5.5	0.5	5	6	6	9	9

Following the voltage code, C designates Standard, L designates Low ESR Ratings



SRC9000 Series



High Reliability Tantalum Capacitors for Space Applications

Part Number	Case Size	Cap (nom) (μF)	DC rated voltage (85°C) (volts)	ESR (max) 100 kHz +25°C (ohms)	DC Leakage (max)			Dissipation Factor (max)		
					+25°C (μA)	+85°C (μA)	+125°C (μA)	+25°C (%)	+85/125°C (%)	-55°C (%)
TAZC475*006L□#@90++	C	4.7	6	2.2	1	10	12	6	8	8
TBJA685*006C□#@90++	A	6.8	6	5	0.5	5	10	6	9	10
TBJB685*006C□#@90++	B	6.8	6	4.5	0.5	5	6	6	9	9
TAZB685*006L□#@90++	B	6.8	6	3.2	1	10	12	6	8	8
TAZD685*006L□#@90++	D	6.8	6	1.5	1	10	12	6	8	8
TBJA106*006C□#@90++	A	10	6	4	1	10	20	6	9	10
TAZB106*006L□#@90++	B	10	6	3.2	1	10	12	6	8	8
TBJB106*006C□#@90++	B	10	6	3.5	0.6	6	7.2	6	9	9
TAZE106*006L□#@90++	E	10	6	1	1	10	12	8	10	12
TBJA156*006C□#@90++	A	15	6	3.5	1	10	20	6	9	10
TBJA156*006L□#@90++	A	15	6	1.5	1	10	20	6	9	10
TBJB156*006C□#@90++	B	15	6	3.5	1	10	20	6	9	10
TAZB156*006L□#@90++	B	15	6	3.2	1	10	12	8	10	10
TBJC156*006C□#@90++	C	15	6	3	0.9	9	10.8	6	9	9
TAZD156*006L□#@90++	D	15	6	1.7	1	10	12	8	10	12
TAZE156*006L□#@90++	E	15	6	0.9	1	10	12	8	10	12
TBJA226*006C□#@90++	A	22	6	3	1.4	14	28	6	9	10
TBJB226*006C□#@90++	B	22	6	2.5	1.4	14	28	6	9	10
TBJC226*006C□#@90++	C	22	6	2.2	1.4	14	16.8	6	9	9
TAZD226*006L□#@90++	D	22	6	1.7	1	10	12	6	8	8
TAZE226*006L□#@90++	E	22	6	1	2	20	24	8	10	12
TAZF226*006L□#@90++	F	22	6	0.6	2	20	24	8	10	12
TBJB336*006C□#@90++	B	33	6	2.2	2.1	21	42	6	9	10
TBJB336*006L□#@90++	B	33	6	0.6	2.1	21	42	6	9	10
TBJC336*006C□#@90++	C	33	6	1.8	2.1	21	42	6	9	10
TAZE336*006L□#@90++	E	33	6	1	2	20	24	6	8	8
TBJC476*006C□#@90++	C	47	6	1.6	3	30	60	6	9	10
TBJD476*006C□#@90++	D	47	6	1.1	2.8	28	33.6	6	9	9
TAZF476*006L□#@90++	F	47	6	1	3	30	36	8	10	12
TAZG476*006L□#@90++	G	47	6	0.275	3	30	36	10	12	12
TBJB686*006C□#@90++	B	68	6	1.8	4.3	43	86	8	10	12
TBJC686*006C□#@90++	C	68	6	1.6	4.3	43	86	6	9	10
TBJD686*006C□#@90++	D	68	6	0.9	4.3	43	86	6	9	9
TAZF686*006L□#@90++	F	68	6	0.4	4	40	48	10	12	12
TAZG686*006L□#@90++	G	68	6	0.25	4	40	48	10	12	12
TAZH686*006L□#@90++	H	68	6	0.18	4	40	48	10	12	12
TBJC107*006C□#@90++	C	100	6	0.9	6.3	63	126	6	9	10
TBJC107*006L□#@90++	C	100	6	0.15	6.3	63	126	6	9	10
TBJD107*006C□#@90++	D	100	6	0.9	6.3	63	126	6	9	10
TAZG107*006L□#@90++	G	100	6	0.275	6	60	72	10	12	12
TBJD157*006C□#@90++	D	150	6	0.9	9.5	95	190	6	9	10
TAZG157*006L□#@90++	G	150	6	0.275	10	100	120	10	12	12
TBJC227*006C□#@90++	C	220	6	1.2	13.9	139	278	10	12	14
TBJD227*006C□#@90++	D	220	6	0.9	13.9	139	278	8	10	12
TBJD227*006L□#@90++	D	220	6	0.1	13.9	139	278	8	10	12

Following the voltage code, C designates Standard, L designates Low ESR Ratings



SRC9000 Series



High Reliability Tantalum Capacitors for Space Applications

Part Number	Case Size	Cap (nom) (μF)	DC rated voltage (85°C) (volts)	ESR (max) 100 kHz +25°C (ohms)	DC Leakage (max)			Dissipation Factor (max)		
					+25°C (μA)	+85°C (μA)	+125°C (μA)	+25°C (%)	+85/125°C (%)	-55°C (%)
TAZH227*006L□#@90++	H	220	6	0.18	10	100	120	10	12	12
TBJE337*006C□#@90++	E	330	6	0.9	19.8	198	396	8	10	12
TBJE337*006L□#@90++	E	330	6	0.1	20.8	208	416	8	10	12
TAZH337*006L□#@90++	H	330	6	0.18	20	200	240	10	12	12
TBJE477M006C□#@90++	E	470	6	0.9	29.6	296	592	10	12	14
TBJE477M006L□#@90++	E	470	6	0.05	29.6	296	592	10	12	14
TBJV477*006L□#@90++	V	470	6	0.1	29.6	296	592	10	12	12
TAZA105*010L□#@90++	A	1	10	5	1	10	12	6	8	8
TBJA105*010C□#@90++	A	1	10	10	0.5	5	6	4	6	6
TBJA155*010C□#@90++	A	1.5	10	8	0.5	5	6	6	6	9
TAZA225*010L□#@90++	A	2.2	10	6	1	10	12	6	8	8
TBJA225*010C□#@90++	A	2.2	10	8	0.5	5	6	6	9	9
TAZB225*010L□#@90++	B	2.2	10	3.2	1	10	12	6	8	8
TBJA335*010C□#@90++	A	3.3	10	5.5	0.5	5	10	6	9	10
TAZA335*010L□#@90++	A	3.3	10	6	1	10	12	6	8	8
TBJB335*010C□#@90++	B	3.3	10	5.5	0.5	5	6	6	9	9
TAZC335*010L□#@90++	C	3.3	10	2.2	1	10	12	6	8	8
TBJA475*010C□#@90++	A	4.7	10	5	0.5	5	10	6	9	10
TAZB475*010L□#@90++	B	4.7	10	3.2	1	10	12	6	8	8
TBJB475*010C□#@90++	B	4.7	10	4.5	0.5	5	6	6	9	9
TAZC475*010L□#@90++	C	4.7	10	2.2	1	10	12	6	8	8
TAZD475*010L□#@90++	D	4.7	10	1.5	1	10	12	6	8	8
TBJA685*010C□#@90++	A	6.8	10	4	0.7	7	14	6	9	10
TAZB685*010L□#@90++	B	6.8	10	3.2	1	10	12	6	8	8
TBJB685*010C□#@90++	B	6.8	10	3.5	0.7	7	8.4	6	9	9
TAZC685*010L□#@90++	C	6.8	10	2.2	1	10	12	6	8	8
TAZD685*010L□#@90++	D	6.8	10	1.7	1	10	12	6	8	8
TAZE685*010L□#@90++	E	6.8	10	1	1	10	12	6	8	8
TBJA106*010C□#@90++	A	10	10	3	1	10	20	6	9	10
TBJA106*010L□#@90++	A	10	10	1.8	1	10	20	6	9	10
TAZB106*010L□#@90++	B	10	10	3.2	1	10	12	8	10	10
TBJB106*010C□#@90++	B	10	10	2.5	1	10	20	6	9	10
TAZC106*010L□#@90++	C	10	10	2.2	1	10	12	6	8	8
TBJC106*010C□#@90++	C	10	10	2.5	1	10	20	6	9	10
TAZD106*010L□#@90++	D	10	10	1.3	1	10	12	6	8	8
TAZE106*010L□#@90++	E	10	10	1	1	10	12	6	8	8
TBJA156*010C□#@90++	A	15	10	3.2	1.6	16	32	6	9	10
TBJB156*010C□#@90++	B	15	10	2.8	1.6	16	32	6	9	10
TBJC156*010C□#@90++	C	15	10	2.5	1.5	15	18	6	6	9
TAZD156*010L□#@90++	D	15	10	1.7	2	20	24	6	8	8
TAZE156*010L□#@90++	E	15	10	0.9	2	20	24	8	10	10
TAZF156*010L□#@90++	F	15	10	0.7	2	20	24	8	8	10
TBJB226*010C□#@90++	B	22	10	2.4	2.2	22	44	6	9	10
TBJB226*010L□#@90++	B	22	10	0.7	2.2	22	44	6	9	10
TBJC226*010C□#@90++	C	22	10	1	2.2	22	44	6	9	10

Following the voltage code, C designates Standard, L designates Low ESR Ratings



SRC9000 Series



High Reliability Tantalum Capacitors for Space Applications

Part Number	Case Size	Cap (nom) (μF)	DC rated voltage (85°C) (volts)	ESR (max) 100 kHz +25°C (ohms)	DC Leakage (max)			Dissipation Factor (max)		
					+25°C (μA)	+85°C (μA)	+125°C (μA)	+25°C (%)	+85/125°C (%)	-55°C (%)
TAZE226*010L□#@90++	E	22	10	0.6	3	30	36	8	10	10
TBJB336*010C□#@90++	B	33	10	1.8	3.3	33	66	6	9	10
TBJC336*010C□#@90++	C	33	10	1.6	3.3	33	66	6	9	10
TBJD336*010C□#@90++	D	33	10	1.1	3.3	33	39.6	6	9	9
TAZF336*010L□#@90++	F	33	10	0.4	3	30	36	8	10	10
TAZG336*010L□#@90++	G	33	10	0.275	3	30	36	10	12	12
TBJC476*010C□#@90++	C	47	10	1.2	4.7	47	94	6	9	10
TBJD476*010C□#@90++	D	47	10	0.9	4.7	47	56.4	6	9	9
TAZF476*010L□#@90++	F	47	10	0.4	4	40	48	10	12	12
TAZG476*010L□#@90++	G	47	10	0.25	4	40	48	10	12	12
TAZH476*010L□#@90++	H	47	10	0.18	5	50	60	10	12	12
TBJC686*010C□#@90++	C	68	10	1.2	6.8	68	136	8	10	12
TBJD686*010C□#@90++	D	68	10	0.9	6.8	68	136	6	9	10
TAZG686*010L□#@90++	G	68	10	0.275	6	60	72	10	12	12
TBJC107*010C□#@90++	C	100	10	1.2	10	100	200	8	10	12
TBJD107*010L□#@90++	C	100	10	0.2	10	100	200	8	10	12
TBJD107*010C□#@90++	D	100	10	0.9	10	100	200	6	9	10
TBJD107*010L□#@90++	D	100	10	0.1	10	100	200	6	9	10
TAZG107*010L□#@90++	G	100	10	0.275	10	100	120	10	12	12
TAZH107*010L□#@90++	H	100	10	0.18	10	100	120	10	12	12
TBJD157*010C□#@90++	D	150	10	0.9	15	150	300	8	10	12
TBJD157*010L□#@90++	D	150	10	0.1	15	150	300	8	10	12
TAZH157*010L□#@90++	H	150	10	0.18	15	150	180	10	12	12
TAZX157*010L□#@90++	X	150	10	0.065	15	150	180	10	12	12
TAZH227*010L□#@90++	H	220	10	0.18	20	200	240	10	12	12
TBJD227M010C□#@90++	D	220	10	0.9	22	220	440	8	10	12
TBJD227M010L□#@90++	D	220	10	0.15	22	220	440	8	10	12
TBJE227*010C□#@90++	E	220	10	0.9	22	220	440	8	10	12
TBJE227*010L□#@90++	E	220	10	0.1	22	220	440	8	10	12
TBJD337M010C□#@90++	D	330	10	0.9	33	330	660	8	10	12
TBJD337M010L□#@90++	D	330	10	0.15	33	330	660	8	10	12
TBJE337*010C□#@90++	E	330	10	0.9	33	330	660	8	10	12
TBJE337*010L□#@90++	E	330	10	0.06	33	330	660	8	10	12
TBJV337*010L□#@90++	V	330	10	0.1	33	330	660	8	10	12
TBJE477M010C□#@90++	E	470	10	0.9	47	470	940	10	12	14
TBJE477M010L□#@90++	E	470	10	0.05	47	470	940	10	12	14
TBJV477*010L□#@90++	V	470	10	0.1	47	470	940	10	12	14
TAZA684*015L□#@90++	A	0.68	15	6	1	10	12	6	8	8
TBJA684*015C□#@90++	A	0.68	15	12	0.5	5	6	4	6	6
TAZA105*015L□#@90++	A	1	15	7.5	1	10	12	6	8	8
TBJA105*015C□#@90++	A	1	15	10	0.5	5	6	4	6	6
TAZA155*015L□#@90++	A	1.5	15	7.5	1	10	12	6	8	8
TBJA155*015C□#@90++	A	1.5	15	8	0.5	5	6	6	9	9
TAZB155*015L□#@90++	B	1.5	15	3.2	1	10	12	6	8	8
TAZA225*015L□#@90++	A	2.2	15	7.5	1	10	12	6	8	8

Following the voltage code, C designates Standard, L designates Low ESR Ratings



SRC9000 Series



High Reliability Tantalum Capacitors for Space Applications

Part Number	Case Size	Cap (nom) (μF)	DC rated voltage (85°C) (volts)	ESR (max) 100 kHz +25°C (ohms)	DC Leakage (max)			Dissipation Factor (max)		
					+25°C (μA)	+85°C (μA)	+125°C (μA)	+25°C (%)	+85/125°C (%)	-55°C (%)
TBJA225*015C□#@90++	A	2.2	15	5.5	0.5	5	10	6	9	10
TBJB225*015C□#@90++	B	2.2	15	5	0.5	5	6	6	9	9
TAZC225*015L□#@90++	C	2.2	15	2.2	1	10	12	6	8	8
TBJA335*015C□#@90++	A	3.3	15	5	0.5	5	10	6	9	10
TBJA335*015L□#@90++	A	3.3	15	3.5	0.5	5	10	6	9	10
TAZB335*015L□#@90++	B	3.3	15	3.6	1	10	12	6	8	8
TBJB335*015C□#@90++	B	3.3	15	5	0.5	5	6	6	8	9
TAZD335*015L□#@90++	D	3.3	15	1.7	1	10	12	6	8	8
TBJA475*015C□#@90++	A	4.7	15	4	0.8	8	16	6	9	10
TAZB475*015L□#@90++	B	4.7	15	2	1	10	12	6	8	8
TBJB475*015C□#@90++	B	4.7	15	4	0.7	7	8.4	6	9	9
TAZC475*015L□#@90++	C	4.7	15	2.2	1	10	12	6	8	8
TAZD475*015L□#@90++	D	4.7	15	2	1	10	12	6	8	8
TAZE475*015L□#@90++	E	4.7	15	1.2	1	10	12	6	8	8
TAZD685*015L□#@90++	D	6.8	15	2	1	10	12	6	8	8
TBJA685*015C□#@90++	A	6.8	15	2.5	1.1	11	22	6	9	10
TBJB685*015C□#@90++	B	6.8	15	2.5	1.1	11	22	6	9	10
TBJC685*015C□#@90++	C	6.8	15	2.5	1.1	11	22	6	9	10
TAZE685*015L□#@90++	E	6.8	15	0.9	1	10	12	8	10	12
TBJB106*015C□#@90++	B	10	15	2.8	1.6	16	32	6	9	10
TBJC106*015C□#@90++	C	10	15	2.5	1.6	16	19.2	6	8	9
TAZD106*015L□#@90++	D	10	15	2	2	20	24	6	8	8
TAZE106*015L□#@90++	E	10	15	1.2	2	20	24	6	8	8
TAZF106*015L□#@90++	F	10	15	0.667	2	20	24	6	8	8
TBJB156*015C□#@90++	B	15	15	2.5	2.4	24	48	6	9	10
TBJB156*015L□#@90++	B	15	15	0.8	2.4	24	48	6	9	10
TBJC156*015C□#@90++	C	15	15	1.8	2.4	24	48	6	9	10
TAZE156*015L□#@90++	E	15	15	1.2	2	20	24	6	8	8
TAZF156*015L□#@90++	F	15	15	0.8	2	20	24	8	10	10
TBJB226*015C□#@90++	B	22	15	2.3	3.6	36	72	6	9	10
TBJC226*015C□#@90++	C	22	15	1.6	3.6	36	72	6	9	10
TBJC226*015L□#@90++	C	22	15	0.375	3.6	36	72	6	9	10
TBJD226*015C□#@90++	D	22	15	1.1	3.3	33	39.6	6	8	9
TAZF226*015L□#@90++	F	22	15	0.8	3	30	36	8	10	10
TAZG226*015L□#@90++	G	22	15	0.275	4	40	48	6	8	8
TBJC336*015C□#@90++	C	33	15	1.5	5.3	53	106	6	9	10
TBJC336*015L□#@90++	C	33	15	0.3	5.3	53	106	6	9	10
TBJD336*015C□#@90++	D	33	15	0.9	5.3	53	106	6	9	9
TAZF336*015L□#@90++	F	33	15	0.8	5	50	60	6	8	8
TAZG336*015L□#@90++	G	33	15	0.275	6	60	72	8	10	10
TAZH336*015L□#@90++	H	33	15	0.18	5	50	60	8	8	10
TBJC476*015C□#@90++	C	47	15	1.5	7.6	76	152	6	9	10
TBJC476*015L□#@90++	C	47	15	0.35	7.6	76	152	6	9	10
TBJD476*015C□#@90++	D	47	15	0.9	7.6	76	152	6	9	10
TBJD476*015L□#@90++	D	47	15	0.15	7.6	76	152	6	9	10

Following the voltage code, C designates Standard, L designates Low ESR Ratings



SRC9000 Series



High Reliability Tantalum Capacitors for Space Applications

Part Number	Case Size	Cap (nom) (µF)	DC rated voltage (85°C) (volts)	ESR (max) 100 kHz +25°C (ohms)	DC Leakage (max)			Dissipation Factor (max)		
					+25°C (µA)	+85°C (µA)	+125°C (µA)	+25°C (%)	+85/125°C (%)	-55°C (%)
TAZG476*015L□#@90++	G	47	15	0.275	10	100	120	8	10	10
TAZH476*015L□#@90++	H	47	15	0.18	10	100	120	8	10	10
TBJD686*015C□#@90++	D	68	15	0.9	10.9	109	218	6	9	10
TAZG686*015L□#@90++	G	68	15	0.275	10	100	120	8	10	10
TAZH686*015L□#@90++	H	68	15	0.18	10	100	120	8	10	10
TBJD107*015C□#@90++	D	100	15	0.9	16	160	320	6	9	10
TBJD107*015L□#@90++	D	100	15	0.125	16	160	320	6	9	10
TBJE107*015C□#@90++	E	100	15	0.9	16	160	320	6	9	10
TBJE107*015L□#@90++	E	100	15	0.1	16	160	320	6	9	10
TAZH107*015L□#@90++	H	100	15	0.18	15	150	180	10	12	12
TBJD157M015C□#@90++	D	150	15	0.9	24	240	480	6	9	10
TBJD157M015L□#@90++	D	150	15	0.15	24	240	480	6	9	10
TBJV157*015L□#@90++	V	150	15	0.045	24	480	960	6	8	10
TBJV227*015L□#@90++	V	220	15	0.15	35.2	352	704	8	10	12
TAZA474*020L□#@90++	A	0.47	20	7.5	1	10	12	8	8	10
TBJA474*020C□#@90++	A	0.47	20	14	0.5	5	6	4	6	6
TAZA684*020L□#@90++	A	0.68	20	7.5	1	10	12	6	8	8
TBJA684*020C□#@90++	A	0.68	20	12	0.5	5	6	4	6	6
TAZB684*020L□#@90++	B	0.68	20	5.6	1	10	12	6	8	8
TAZA105*020L□#@90++	A	1	20	7.5	1	10	12	6	8	8
TBJA105*020C□#@90++	A	1	20	10	0.5	5	6	4	6	6
TAZB105*020L□#@90++	B	1	20	4.8	1	10	12	6	8	8
TBJA155*020C□#@90++	A	1.5	20	6.5	0.5	5	10	6	8	10
TAZB155*020L□#@90++	B	1.5	20	3.6	1	10	12	6	8	8
TBJB155*020C□#@90++	B	1.5	20	6	0.5	5	6	6	9	9
TAZC155*020L□#@90++	C	1.5	20	2.4	1	10	12	6	8	8
TAZB225*020L□#@90++	B	2.2	20	3.6	1	10	12	6	8	8
TBJB225*020C□#@90++	B	2.2	20	5	0.5	5	6	6	8	9
TAZD226*020L□#@90++	D	2.2	20	1.7	1	10	12	6	8	8
TBJB335*020C□#@90++	B	3.3	20	4	0.7	7	8.4	6	9	9
TAZD335*020L□#@90++	D	3.3	20	2	1	10	12	6	8	8
TAZE335*020L□#@90++	E	3.3	20	1.2	1	10	12	6	8	8
TBJA475*020C□#@90++	A	4.7	20	4	1	10	20	6	8	10
TBJA475*020L□#@90++	A	4.7	20	1.8	1	10	20	6	8	10
TBJB475*020C□#@90++	B	4.7	20	3	2	20	40	6	8	10
TBJC475*020C□#@90++	C	4.7	20	3	1	10	12	6	8	9
TAZE475*020L□#@90++	E	4.7	20	1.7	1	10	12	6	8	8
TBJB685*020C□#@90++	B	6.8	20	2.5	1.4	14	28	6	8	10
TBJC685*020C□#@90++	C	6.8	20	2.4	1.4	14	16.8	6	9	9
TAZE685*020L□#@90++	E	6.8	20	1.5	2	20	24	6	8	8
TAZF685*020L□#@90++	F	6.8	20	0.7	2	20	24	6	8	8
TBJB106*020C□#@90++	B	10	20	2.1	0.7	7	14	6	8	10
TBJB106*020L□#@90++	B	10	20	1	0.7	7	14	6	8	10
TBJC106*020C□#@90++	C	10	20	1.9	1.4	14	28	6	8	10
TAZE106*020L□#@90++	E	10	20	1.5	2	20	24	6	8	8

Following the voltage code, C designates Standard, L designates Low ESR Ratings



SRC9000 Series



High Reliability Tantalum Capacitors for Space Applications

Part Number	Case Size	Cap (nom) (μF)	DC rated voltage (85°C) (volts)	ESR (max) 100 kHz +25°C (ohms)	DC Leakage (max)			Dissipation Factor (max)		
					+25°C (μA)	+85°C (μA)	+125°C (μA)	+25°C (%)	+85/125°C (%)	-55°C (%)
TAZF106*020L□#@90++	F	10	20	0.8	2	20	24	6	8	8
TBJB156*020C□#@90++	B	15	20	2	3	30	60	6	8	10
TBJC156*020C□#@90++	C	15	20	1.7	3	30	60	6	8	10
TBJD156*020C□#@90++	D	15	20	1.1	3	30	36	6	8	9
TAZF156*020L□#@90++	F	15	20	0.8	3	30	36	6	8	8
TAZG156*020L□#@90++	G	15	20	0.275	3	30	36	6	8	8
TAZG226*020L□#@90++	G	22	20	0.625	4	40	48	6	8	8
TBJC226*020C□#@90++	C	22	20	1.6	4.4	44	88	6	8	10
TBJD226*020C□#@90++	D	22	20	0.9	4.4	44	52.8	6	9	9
TAZH226*020L□#@90++	H	22	20	0.18	4	40	48	6	8	8
TBJC336*020C□#@90++	C	33	20	1.5	6.6	66	132	6	8	10
TBJD336*020C□#@90++	D	33	20	0.9	6.6	66	132	6	8	10
TBJD336*020L□#@90++	D	33	20	0.2	6.6	66	132	6	8	10
TAZH336*020L□#@90++	H	33	20	0.18	6	60	72	8	10	10
TBJD476*020C□#@90++	D	47	20	0.9	9.4	94	188	6	8	10
TAZH476*020L□#@90++	H	47	20	0.18	10	100	120	8	10	10
TAZX476*020L□#@90++	X	47	20	0.11	10	100	120	8	10	10
TBJD686*020C□#@90++	D	68	20	0.9	13.6	136	272	6	8	10
TBJE686*020C□#@90++	E	68	20	0.9	13.6	136	272	6	8	10
TBJE686*020L□#@90++	E	68	20	0.15	13.6	136	272	6	8	10
TBJV107*020L□#@90++	V	100	20	0.2	20	200	400	8	10	12
TAZA334*025L□#@90++	A	0.33	25	7.5	1	10	12	6	8	8
TBJA334*025C□#@90++	A	0.33	25	15	0.5	5	6	4	6	6
TAZA474*025L□#@90++	A	0.47	25	7.5	1	10	12	6	8	8
TBJA474*025C□#@90++	A	0.47	25	14	0.5	5	6	4	6	6
TAZB684*025L□#@90++	B	0.68	25	4	1	10	12	6	8	8
TBJB684*025C□#@90++	B	0.68	25	7.5	0.5	5	6	4	6	6
TBJA684M025C□#@90++	A	0.68	25	10	0.5	5	10	4	6	8
TBJA105*025C□#@90++	A	1	25	8	0.5	5	10	4	6	8
TAZB105*025L□#@90++	B	1	25	4	1	10	12	6	8	8
TBJB105*025C□#@90++	B	1	25	6.5	0.5	5	6	4	6	6
TAZC105*025L□#@90++	C	1	25	2.6	1	10	12	6	8	8
TBJA155*025C□#@90++	A	1.5	25	7.5	0.5	5	10	6	8	10
TBJA155*025L□#@90++	A	1.5	25	3	0.5	5	10	6	8	10
TBJB155*025C□#@90++	B	1.5	25	6.5	0.5	5	6	6	8	9
TAZD155*025L□#@90++	D	1.5	25	1.7	1	10	12	6	8	8
TAZD225*025L□#@90++	D	2.2	25	2	1	10	12	6	8	8
TBJA225*025C□#@90++	A	2.2	25	7	0.5	5	10	6	8	10
TBJB225*025C□#@90++	B	2.2	25	4.5	0.5	5	10	6	8	10
TBJC225*025C□#@90++	C	2.2	25	3.5	0.6	6	7.2	6	9	9
TAZE225*025L□#@90++	E	2.2	25	1	1	10	12	6	8	8
TBJB335*025C□#@90++	B	3.3	25	3.5	0.5	5	10	6	8	10
TBJC335*025C□#@90++	C	3.3	25	3.5	0.9	9	10.8	6	8	9
TBJA475*025C□#@00++	A	4.7	25	3.1	1.2	12	14.4	6	9	10
TAZE335*025L□#@90++	E	3.3	25	1.2	1	10	12	6	8	8
TBJB475*025C□#@90++	B	4.7	25	2.8	1.2	12	24	6	8	10

Following the voltage code, C designates Standard, L designates Low ESR Ratings



SRC9000 Series



High Reliability Tantalum Capacitors for Space Applications

Part Number	Case Size	Cap (nom) (µF)	DC rated voltage (85°C) (volts)	ESR (max) 100 kHz +25°C (ohms)	DC Leakage (max)			Dissipation Factor (max)		
					+25°C (µA)	+85°C (µA)	+125°C (µA)	+25°C (%)	+85/125°C (%)	-55°C (%)
TBJB475*025L□#@90++	B	4.7	25	1.5	1.2	12	24	6	8	10
TBJC475*025C□#@90++	C	4.7	25	2.5	1.2	12	14.4	6	9	9
TAZF475*025L□#@90++	F	4.7	25	0.7	2	20	24	6	8	8
TBJB685*025C□#@90++	B	6.8	25	2.8	1.7	17	34	6	8	10
TBJC685*025C□#@90++	C	6.8	25	2	1.7	17	34	6	8	10
TBJD685*025C□#@90++	D	6.8	25	1.4	1.7	17	20.4	6	9	9
TAZF685*025L□#@90++	F	6.8	25	0.8	2	20	24	6	8	8
TAZG685*025L□#@90++	G	6.8	25	0.3	2	20	24	6	8	8
TBJC106*025C□#@90++	C	10	25	1.8	2.5	25	50	6	8	10
TBJC106*025L□#@90++	C	10	25	0.5	2.5	25	50	6	8	10
TBJD106*025C□#@90++	D	10	25	1.2	2.5	25	30	6	8	9
TAZG106*025L□#@90++	G	10	25	0.35	3	30	36	6	8	8
TBJD156*025C□#@90++	D	15	25	1	3.8	38	45.6	6	9	9
TAZG156*025L□#@90++	G	15	25	0.35	4	40	48	6	8	8
TAZH156*025L□#@90++	H	15	25	0.2	4	40	48	6	8	8
TBJC226*025C□#@90++	C	22	25	1.4	5.5	55	110	6	8	10
TBJD226*025C□#@90++	D	22	25	0.9	5.5	55	110	6	8	10
TBJD226*025L□#@90++	D	22	25	0.2	5.5	55	110	6	8	10
TAZG226*025L□#@90++	G	22	25	0.35	6	60	72	6	8	8
TAZH226*025L□#@90++	H	22	25	0.18	6	60	72	6	8	8
TAZX226*025L□#@90++	X	22	25	0.16	6	60	72	6	8	8
TBJD336*025C□#@90++	D	33	25	0.9	8.3	83	166	6	8	10
TBJE336*025C□#@90++	E	33	25	0.9	8.3	83	166	6	8	10
TBJE336*025L□#@90++	E	33	25	0.3	8.3	83	166	6	8	10
TAZH336*025L□#@90++	H	33	25	0.18	10	100	120	6	8	8
TAZX336*025L□#@90++	X	33	25	0.13	10	100	120	8	10	10
TBJD476M025C□#@90++	D	47	25	0.9	11.8	118	236	6	8	10
TBJD476M025L□#@90++	D	47	25	0.25	11.8	118	236	6	8	10
TBJV686*025L□#@90++	V	68	25	0.15	17	170	340	8	10	12
TBJA104*035C□#@90++	A	0.1	35	24	0.5	5	6	4	6	6
TBJA154*035C□#@90++	A	0.15	35	21	0.5	5	6	4	6	6
TAZA224*035L□#@90++	A	0.22	35	12	1	10	12	6	8	8
TBJA224*035C□#@90++	A	0.22	35	18	0.5	5	6	4	6	6
TAZA334*035L□#@90++	A	0.33	35	12	1	10	12	6	8	8
TBJA334*035C□#@90++	A	0.33	35	15	0.5	5	6	4	6	6
TBJA474M035C□#@90++	A	0.47	35	12	0.5	5	10	4	6	8
TAZB474*035L□#@90++	B	0.47	35	6.8	1	10	12	6	8	8
TBJB474*035C□#@90++	B	0.47	35	10	0.5	5	6	4	6	6
TBJA684M035C□#@90++	A	0.68	35	8	0.5	5	10	4	6	8
TBJB684*035C□#@90++	B	0.68	35	8	0.5	5	6	4	6	6
TAZC684*035L□#@90++	C	0.68	35	4	1	10	12	6	8	8
TBJA105*035C□#@90++	A	1	35	7.5	0.5	5	10	4	6	6
TBJB105*035C□#@90++	B	1	35	6.5	0.5	5	6	4	6	6
TAZD105*035L□#@90++	D	1	35	2.2	1	10	12	6	8	8
TBJA155*035C□#@90++	A	1.5	35	7.5	0.5	5	10	6	8	9

Following the voltage code, C designates Standard, L designates Low ESR Ratings



SRC9000 Series



High Reliability Tantalum Capacitors for Space Applications

Part Number	Case Size	Cap (nom) (µF)	DC rated voltage (85°C) (volts)	ESR (max) 100 kHz +25°C (ohms)	DC Leakage (max)			Dissipation Factor (max)		
					+25°C (µA)	+85°C (µA)	+125°C (µA)	+25°C (%)	+85/125°C (%)	-55°C (%)
TBJB155*035C□#@90++	B	1.5	35	5.2	0.5	5	10	6	8	9
TBJC155*035C□#@90++	C	1.5	35	4.5	0.5	5	6	6	8	9
TAZE155*035L□#@90++	E	1.5	35	1.3	1	10	12	6	8	8
TBJB225*035C□#@90++	B	2.2	35	4.2	0.8	8	16	6	8	9
TBJC225*035C□#@90++	C	2.2	35	3.5	0.8	8	9.6	6	8	9
TBJB335*035C□#@90++	B	3.3	35	3.5	1.2	12	24	6	8	9
TBJC335*035C□#@90++	C	3.3	35	2.5	1.2	12	14.4	6	8	9
TAZF335*035L□#@90++	F	3.3	35	0.7	1	10	12	6	8	8
TBJB475*035C□#@90++	B	4.7	35	3.1	1.6	16	32	6	8	9
TBJC475*035C□#@90++	C	4.7	35	2.2	1.6	16	32	6	8	9
TBJC475*035L□#@90++	C	4.7	35	0.6	1.6	16	32	6	8	9
TBJD475*035C□#@90++	D	4.7	35	1.5	1.7	17	20.4	6	8	9
TAZG475*035L□#@90++	G	4.7	35	0.375	2	20	24	6	8	8
TAZG685*035L□#@90++	G	6.8	35	0.375	3	30	36	6	8	8
TAZH685*035L□#@90++	H	6.8	35	0.5	3	30	36	6	8	8
TBJC685*035C□#@90++	C	6.8	35	1.8	2.4	24	48	6	9	9
TBJD685*035C□#@90++	D	6.8	35	1.3	2.4	24	28.8	6	9	9
TBJC106*035C□#@90++	C	10	35	1.6	3.5	35	70	6	9	9
TBJD106*035C□#@90++	D	10	35	1	3.5	35	70	6	9	9
TBJD106*035L□#@90++	D	10	35	0.3	3.5	35	70	6	9	9
TAZH106*035L□#@90++	H	10	35	0.5	4	40	48	8	10	10
TBJC156*035C□#@90++	C	15	35	1.4	5.3	53	106	6	9	9
TBJD156*035C□#@90++	D	15	35	0.9	5.3	53	106	6	9	9
TBJD156*035L□#@90++	D	15	35	0.3	5.3	53	106	6	9	9
TAZJ156*035L□#@90++	X	15	35	0.19	6	60	72	6	8	8
TBJD226*035C□#@90++	D	22	35	0.9	7.7	77	154	6	9	9
TBJD226*035L□#@90++	D	22	35	0.4	7.7	77	154	6	9	9
TBJE226*035C□#@90++	E	22	35	0.9	7.7	77	154	6	9	9
TBJE226*035L□#@90++	E	22	35	0.3	7.7	77	154	6	9	9
TBJD336M035C□#@90++	D	33	35	0.9	11.6	116	232	6	9	9
TBJD336M035L□#@90++	D	33	35	0.3	11.6	116	232	6	9	9
TAZA104*050L□#@90++	A	0.1	50	12	1	10	12	6	8	8
TBJA104*050C□#@90++	A	0.1	50	22	0.5	5	12	6	8	8
TAZA154*050L□#@90++	A	0.15	50	12	1	10	12	6	8	8
TBJA154M050C□#@90++	A	0.15	50	21	0.5	5	10	4	6	6
TBJB154*050C□#@90++	B	0.15	50	17	0.5	5	6	4	6	6
TBJA224M050C□#@90++	A	0.22	50	18	0.5	5	10	4	6	6
TAZB224*050L□#@90++	B	0.22	50	6.8	1	10	12	6	8	8
TBJB224*050C□#@90++	B	0.22	50	14	0.5	5	6	4	6	6
TAZB334*050L□#@90++	B	0.33	50	4.8	1	10	12	6	8	8
TBJB334*050C□#@90++	B	0.33	50	12	0.5	5	6	4	6	6
TAZC474*050L□#@90++	C	0.47	50	3.2	1	10	12	6	8	8
TBJC474*050C□#@90++	C	0.47	50	8	0.5	5	6	4	6	6
TBJC684*050C□#@90++	C	0.68	50	7	0.5	5	6	4	6	6
TAZD684*050L□#@90++	D	0.68	50	2.3	1	10	12	6	8	8

Following the voltage code, C designates Standard, L designates Low ESR Ratings



SRC9000 Series



High Reliability Tantalum Capacitors for Space Applications

Part Number	Case Size	Cap (nom) (μF)	DC rated voltage (85°C) (volts)	ESR (max) 100 kHz +25°C (ohms)	DC Leakage (max)			Dissipation Factor (max)		
					+25°C (μA)	+85°C (μA)	+125°C (μA)	+25°C (%)	+85/125°C (%)	-55°C (%)
TAZE105*050L□#@90++	E	1	50	1.7	1	10	12	6	8	8
TBJC105*050C□#@90++	C	1	50	6	0.5	5	6	4	6	6
TBJC155*050C□#@90++	C	1.5	50	5	0.8	8	16	6	8	9
TBJD155*050C□#@90++	D	1.5	50	4	0.8	8	9.6	6	8	9
TAZF155*050L□#@90++	F	1.5	50	1.1	1	10	12	6	8	8
TBJD225*050C□#@90++	D	2.2	50	2.5	1.1	11	13.2	6	8	9
TAZF225*050L□#@90++	F	2.2	50	0.7	2	20	24	6	8	8
TBJD335*050C□#@90++	D	3.3	50	2	1.7	17	20.4	6	9	9
TAZG335*050L□#@90++	G	3.3	50	0.5	2	20	24	6	8	8
TBJD475*050C□#@90++	D	4.7	50	1.5	2.4	24	28.8	6	9	9
TAZH475*050L□#@90++	H	4.7	50	0.5	3	30	36	6	8	8
TBJD685*050C□#@90++	D	6.8	50	1	3.4	34	68	6	6	6

Following the voltage code, C designates Standard, L designates Low ESR Ratings



TBM Multianode



Tantalum Ultra Low ESR Capacitor COTS-Plus

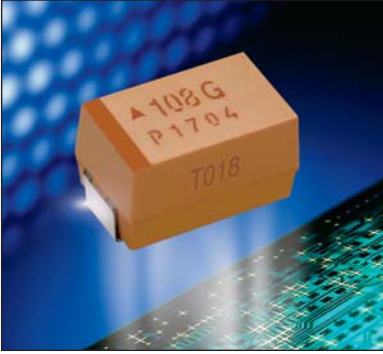

Multianode COTS+ Tantalum capacitors offer the lowest ESR and highest ripple current available in a solid tantalum capacitor. Capacitors are Weibull graded

and surge current tested per the customer's requirements.

TBM are also available with Sn/Pb terminations.

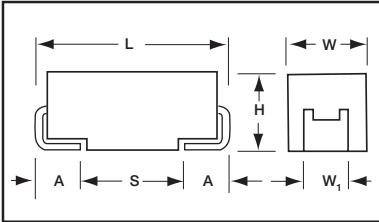

CASE DIMENSIONS: millimeters (inches)

Code	L±0.20 (0.008)	W+0.20 (0.008) -0.10 (0.004)	H+0.20 (0.008) -0.10 (0.004)	W ₁ ±0.20 (0.008)	A+0.30 (0.012) -0.20 (0.008)	S Min.
E	7.30 (0.287)	4.30 (0.169)	4.10 (0.162)	2.40 (0.094)	1.30 (0.051)	4.40 (0.173)

W₁ dimension applies to the termination width for A dimensional area only.

HOW TO ORDER

TBM	E	158	*	002	L		SB	0[^]	++
Type	Case Size	Capacitance Code	Capacitance Tolerance	Voltage Code	ESR	Packaging	Qualification/Reliability	Termination Finish	Surge Test Option
		pF code: 1st two digits represent significant figures 3rd digit represents multiplier (number of zeros to follow)	M = ±20% K = ±10%	002 = 2.5Vdc 004 = 4Vdc 006 = 6Vdc 010 = 10Vdc 015 = 15Vdc 020 = 20Vdc 025 = 25Vdc 035 = 35Vdc	L = Low ESR	B = Bulk R = 7" T&R S = 13" T&R W = Waffle	S = COTS+ B = 0.1% per 1000 hrs.	08 = Tin/Lead 07 = 100% Tin	00 = None 23 = 10 cycles, +25°C 24 = 10 cycles, -55°C & +85°C

NOTE: The EIA & CECC standards for low ESR Solid Tantalum Capacitors allow an ESR movement to 1.25 times catalog limit post mounting.

TECHNICAL SPECIFICATIONS

Technical Data:	All technical data relate to an ambient temperature of +25°C									
Capacitance Range:	22 µF to 1500 µF									
Capacitance Tolerance:	±10%; ±20%									
Rated Voltage DC (V _R)	≤+85°C:	2.5	4	6	10	15	20	25	35	50
Category Voltage (V _C)	≤+125°C:	1.7	2.7	4	7	10	13	17	23	33
Surge Voltage (V _S)	≤+85°C:	3.3	5.2	8	13	20	26	32	46	65
	≤+125°C:	2.2	3.4	5	8	13	16	20	28	40
Temperature Range:	-55°C to +125°C									
Reliability:	1% per 1000 hours at 85°C, V _R with 0.1Ω/V series impedance, 60% confidence level									



TBM Multianode



Tantalum Ultra Low ESR Capacitor COTS-Plus

CAPACITANCE AND RATED VOLTAGE RANGE LETTER DENOTES CASE SIZE ESR LIMIT IN BRACKETS

Capacitance		Rated Voltage DC (V _R) to 85°C								
µF	Code	2.5V (e)	4V (G)	6V (J)	10V (A)	15V (C)	20V (D)	25V (E)	35V (V)	50V (T)
10	106									E(120)
15	156									E(75)
22	226								E(60)	E(75)
33	336								E(50)	
47	476								E(55)	
68	686							E(45)		
100	107						E(35)			
150	157					E(30)				
220	227					E(25)				
330	337				E(23)					
470	477			E(18)	E(23)					
680	687		E(18)	E(18), V(23)						
1000	108		E(18), V(18)							
1500	158	E(12)	E(15)							

RATINGS & PART NUMBER REFERENCE

AVX Part No.	Case Size	Capacitance (µF)	Rated Voltage(V)	DCL (µA) Max.	DF % Max.	ESR Max. (mΩ) @ 100kHz	100kHz Ripple Current Ratings (A)			100kHz Ripple Voltage Ratings (V)		
							25°C	85°C	125°C	25°C	85°C	125°C
TBME158*002L□SB0^++	E	1500	2.5	38	6	12	4.743	4.269	1.897	0.057	0.051	0.023
TBME687*004L□SB0^++	E	680	4	27	6	18	3.873	3.486	1.549	0.070	0.063	0.028
TBME108*004L□SB0^++	E	1000	4	40	6	18	3.873	3.486	1.549	0.070	0.063	0.028
TBMV108*004L□SB0^++	V	1000	4	40	6	18	3.979	3.581	1.592	0.072	0.064	0.029
TBME158*004L□SB0^++	E	1500	4	40	6	15	4.243	3.818	1.697	0.064	0.057	0.025
TBME477*006L□SB0^++	E	470	6	28	6	18	3.873	3.486	1.549	0.070	0.063	0.028
TBME687*006L□SB0^++	E	680	6	41	6	18	3.873	3.486	1.549	0.070	0.063	0.028
TBMV687*006L□SB0^++	V	680	6	41	6	23	3.520	3.168	1.408	0.081	0.073	0.032
TBME337*010L□SB0^++	E	330	10	33	6	23	3.426	3.084	1.370	0.079	0.071	0.032
TBME477*010L□SB0^++	E	470	10	47	6	23	3.426	3.084	1.370	0.079	0.071	0.032
TBME157*015L□SB0^++	E	150	15	24	6	30	3.000	2.700	1.200	0.090	0.081	0.036
TBME227*015L□SB0^++	E	220	15	35	6	25	3.286	2.958	1.315	0.082	0.074	0.033
TBME107*020L□SB0^++	E	100	20	20	6	35	2.777	2.500	1.111	0.097	0.087	0.039
TBME686*025L□SB0^++	E	68	25	17	6	45	2.449	2.205	0.980	0.110	0.099	0.044
TBME226*035L□SB0^++	E	22	35	8	6	60	2.121	1.909	0.849	0.127	0.115	0.051
TBME336*035L□SB0^++	E	33	35	12	6	50	2.324	2.091	0.930	0.116	0.105	0.046
TBME476*035L□SB0^++	E	47	35	16	6	55	2.216	1.994	0.886	0.122	0.110	0.049
TBME106*050L□SB0^++	E	10	50	5	6	120	1.500	1.350	0.600	0.180	0.162	0.072
TBME156*050L□SB0^++	E	15	50	7.5	6	75	1.897	1.708	0.759	0.142	0.128	0.057
TBME226*050L□SB0^++	E	22	50	11	8	75	1.897	1.708	0.759	0.142	0.128	0.057

All technical data relates to an ambient temperature of +25°C.
Capacitance and DF are measured at 120Hz,
0.5V RMS with maximum DC bias of 2.2 volts.
DCL is measured at rated voltage after 5 minutes.

* Insert K for ±10% and M for ±20% Capacitance Tolerance

TBM MULTIANODE CONSTRUCTION

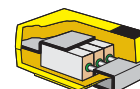

TBW Series



Tantalum Fused Capacitor

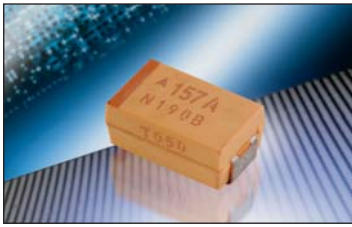

TBW Fused Tantalum Capacitors offer protection from possible damaging short circuit failure modes. This is accomplished with an internal fuse using thin film technology that is in series with the capacitor. See the photograph on the right. The AVX fused tantalum offers lower ESR limits than competitive fused tantalum capacitors, and is available with Weibull and surge testing per MIL PRF 55365.



Anode, fuse and leadframe assembly

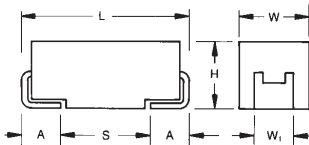

CASE DIMENSIONS: millimeters (inches)

Case Code	Length (L)	Width (W)	Height (H)	Term. Width (W1)	Term. Length (A)	S min
D	7.30±0.30 (0.287±0.012)	4.30±0.30 (0.169±0.012)	2.80±0.30 (0.110±0.012)	2.40 ±0.10 (0.094±0.004)	1.30 ±0.30 (0.051±0.012)	3.80 (0.150)

HOW TO ORDER

TBW	D	476	*	015	C	S	B	0^	++
Type	Case Size	Capacitor Code pF code: 1st two digits represent significant figures, 3rd digit represents multiplier (number of zeros to follow)	Capacitance Tolerance M = ±20% K = ±10%	Voltage Code 015 = 15Vdc 035 = 35Vdc 050 = 50Vdc	ESR Range C = Std ESR	Packaging B = Bulk R = 7" T&R S = 13" T&R W = Waffle	Qualification/Reliability S = Cots+ B = 0.1%/1000 Hrs. D = DSCC Dwg 04053	Termination Finish 08 = Tin/Lead 00 = Solder Fused	Surge Test Option 00 = None 23 = 10 cycles, +25°C 24 = 10 cycles, -55°C & +85°C

TECHNICAL SPECIFICATIONS

Technical Data:	Unless otherwise specified, all technical data relate to an ambient temperature of 25°C				
Capacitance Range:	4.7µF to 47µF				
Capacitance Tolerance:	±10%; ±20%				
Rated Voltage (V _R)	≤ +85°C:	15	35	50	
Category Voltage (V _C)	≤ +125°C:	10	23	33	
Surge Voltage (V _S)	≤ +85°C:	20	46	65	
Surge Voltage (V _S)	≤ +125°C:	13	28	40	
Temperature Range:	-55°C to +125°C				

CAPACITANCE AND RATED VOLTAGE, V_R (VOLTAGE CODE) RANGE (LETTER DENOTES CASE SIZE)

Capacitance		Voltage Rating DC (V _R) to 85°C		
µF	Code	15V	35V	50V
3.3	335			D
4.7	475			D
6.8	685			D
10	106			
15	156			
22	226			
33	336	D		
47	476	D		
68	686	D		

RATINGS & PART NUMBER REFERENCE

Part Number	DSCC Part Number	Case Size	Cap (nom) (µF)	DC rated voltage (85°C) (volts)	ESR (max) 100 kHz +25°C (ohms)	DC Leakage (max)			Dissipation Factor (max)		
						+25°C (µA)	+85°C (µA)	+125°C (µA)	+25°C (%)	+85/125°C (%)	-55°C (%)
TBWD476*015C SB0^++	04053 - 053	D	47	15	0.75	7.6	76.0	152.0	6	9	10
TBWD156*035C SB0^++	04053 - 086	D	15	35	0.75	5.3	53.0	106.0	6	9	9
TBWD475*050C SB0^++	04053 - 097	D	4.7	50	0.75	2.4	24.0	28.8	6	9	9



Technical Summary and Application Guidelines



SECTION 5 MECHANICAL AND THERMAL PROPERTIES OF CAPACITORS

5.1 Acceleration

98.1m/s² (10g)

5.2 Vibration Severity

10 to 2000Hz, 0.75mm of 98.1m/s² (10g)

5.3 Shock

Trapezoidal Pulse, 98.1m/s² for 6ms.

5.4 Adhesion to Substrate

IEC 384-3. minimum of 5N.

5.5 Resistance to Substrate Bending

The component has compliant leads which reduces the risk of stress on the capacitor due to substrate bending.

5.6 Soldering Conditions

Dip soldering is permissible provided the solder bath temperature is $\leq 270^{\circ}\text{C}$, the solder time < 3 seconds and the circuit board thickness $\geq 1.0\text{mm}$.

5.7 Installation Instructions

The upper temperature limit (maximum capacitor surface temperature) must not be exceeded even under the most unfavorable conditions when the capacitor is installed. This must be considered particularly when it is positioned near components which radiate heat strongly (e.g. valves and power transistors). Furthermore, care must be taken, when bending the wires, that the bending forces do not strain the capacitor housing.

5.8 Installation Position

No restriction.

5.9 Soldering Instructions

Fluxes containing acids must not be used.

5.9.1 Guidelines for Surface Mount Footprints

Component footprint and reflow pad design for AVX capacitors.

The component footprint is defined as the maximum board area taken up by the terminators. The footprint dimensions are given by A, B, C and D in the diagram, which corresponds to W, max., A max., S min. and L max. for the component. The footprint is symmetric about the center lines.

The dimensions x, y and z should be kept to a minimum to reduce rotational tendencies while allowing for visual inspection of the component and its solder fillet.

Dimensions PS (Pad Separation) and PW (Pad Width) are calculated using dimensions x and z. Dimension y may vary, depending on whether reflow or wave soldering is to be performed.

For reflow soldering, dimensions PL (Pad Length), PW (Pad Width), and PSL (Pad Set Length) have been calculated. For wave soldering the pad width (PWw) is reduced to less than the termination width to minimize the amount of solder pick up while ensuring that a good joint can be produced.

NOTE: These recommendations (also in compliance with EIA) are guidelines only. With care and control, smaller footprints may be considered for reflow soldering.

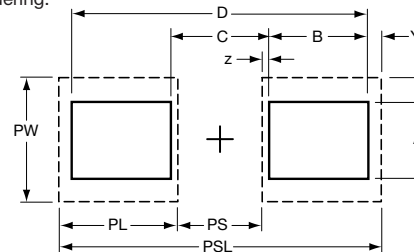

Nominal footprint and pad dimensions for each case size are given in the following tables:

PAD DIMENSIONS: millimeters (inches)

Case Size	PSL	PL	PS	PW	PWw	
TAJ TPS TRJ THJ TPM & CWR11	A	3.80 (0.150)	1.40 (0.054)	1.00 (0.039)	1.80 (0.071)	0.90 (0.035)
	B	4.00 (0.157)	1.40 (0.054)	1.20 (0.047)	2.80 (0.110)	1.60 (0.063)
	C	6.50 (0.256)	2.00 (0.079)	2.50 (0.098)	2.80 (0.110)	1.60 (0.063)
	D	8.00 (0.315)	2.00 (0.079)	4.00 (0.157)	3.00 (0.119)	1.70 (0.068)
	E	8.00 (0.315)	2.00 (0.079)	4.00 (0.157)	3.00 (0.119)	1.70 (0.068)
	R	2.70 (0.100)	0.95 (0.037)	0.80 (0.030)	1.60 (0.060)	0.80 (0.030)
	S	3.80 (0.150)	1.40 (0.054)	1.00 (0.039)	1.80 (0.071)	0.90 (0.035)
	T	4.00 (0.157)	1.40 (0.054)	1.20 (0.047)	2.80 (0.110)	1.60 (0.063)
	V	8.00 (0.315)	2.00 (0.079)	4.00 (0.157)	3.70 (0.145)	1.70 (0.068)
	W	6.50 (0.256)	2.00 (0.079)	2.50 (0.098)	2.80 (0.110)	1.60 (0.063)
TAC TPC	Y	8.00 (0.315)	2.00 (0.079)	4.00 (0.157)	3.00 (0.119)	1.70 (0.068)
	X	8.00 (0.315)	2.00 (0.079)	4.00 (0.157)	3.00 (0.119)	1.70 (0.068)
	P	2.70 (0.100)	0.95 (0.037)	0.80 (0.030)	1.60 (0.060)	0.80 (0.030)
	K	2.20 (0.087)	0.90 (0.035)	0.40 (0.016)	0.70 (0.028)	-
	L	2.80 (0.110)	1.10 (0.043)	0.60 (0.024)	1.00 (0.039)	-
	R/H/U	3.20 (0.126)	1.30 (0.051)	0.60 (0.024)	1.50 (0.059)	-
	X	4.20 (0.165)	1.60 (0.063)	1.00 (0.039)	1.60 (0.063)	-
	A	4.40 (0.173)	1.60 (0.063)	1.20 (0.047)	1.80 (0.071)	-
T	4.70 (0.185)	1.70 (0.070)	1.30 (0.051)	3.00 (0.118)	-	

NOTE: TAJ has a common footprint with TPS/TRJ/THJ/TPM & CWR11 Series.

5.10 PCB Cleaning

Ta chip capacitors are compatible with most PCB board cleaning systems.

If aqueous cleaning is performed, parts must be allowed to dry prior to test. In the event ultrasonics are used power levels should be less than 10 watts per/litre, and care must be taken to avoid vibrational nodes in the cleaning bath.

SECTION 6 EPOXY FLAMMABILITY

EPOXY	UL RATING	OXYGEN INDEX
TAJ/TPS/TRJ/THJ/TPM/CWR11	UL94 V-0	35%

SECTION 7 QUALIFICATION APPROVAL STATUS

DESCRIPTION	STYLE	SPECIFICATION
Surface mount capacitors	TAJ	CECC 30801 - 005 Issue 2 CECC 30801 - 011 Issue 1 MIL-C-55365/8 (CWR11)
	TAZ	MIL-C-55365/4 (CWR09)



Material Data and Handling

This should be read in conjunction with the Product Datasheet. Failure to observe the ratings and the information on this sheet may result in a safety hazard.

1. Material Content

Solid Tantalum and OxiCap™ capacitors do not contain liquid hazardous materials.

The operating section contains:

Tantalum/Niobium	Graphite/carbon
Tantalum/Niobium oxide	Conducting paint/resins
Manganese dioxide	Fluoropolymers (not TAC)

The encapsulation contains:

TAA - solder, metal case, solder coated terminal wires, glass seal and plastic sleeve

TAC - epoxy molding compound, solder/tin coated terminal pads

TAJ, TPS, THJ, NOJ, NOS, NOM - epoxy molding compound, tin/solder coated terminal pads

TAP - solder, solder coated terminal wires, epoxy dipped resin

The epoxy resins may contain Antimony trioxide and Bromine compounds as fire retardants. The capacitors do not contain PBB or PBBO/PBBE. The solder alloys may contain lead.

2. Physical Form

These capacitors are physically small and are either rectangular with solderable terminal pads, or cylindrical or bead shaped with solderable terminal wires.

3. Intrinsic Properties

Operating

Both Tantalum and OxiCap™ capacitors are polarized devices and operate satisfactorily in the correct d.c. mode. They will withstand a limited application of reverse voltage as stated in the datasheets. However, a reverse application of the rated voltage will result in early short circuit failure and may result in fire or explosion. Consequential failure of other associated components in the circuit e.g. diodes, transformers, etc. may also occur. When operated in the correct polarity, a long period of satisfactory operation will be obtained but failure may occur for any of the following reasons:

- normal failure rate
- surge voltage exceeded
- reverse voltage exceeded
- temperature too high
- ripple rating exceeded

If this failure mode is a short circuit, the previous conditions apply. If the adjacent circuit impedance is low, voltage or current surges may exceed the power handling capability of the capacitor. For this reason capacitors in circuits of below 1Ω/V should be derated by minimum 50% for tantalum and 20% for OxiCap™. Precautions should be taken to prevent reverse voltage spikes. Where capacitors may be subjected to fast switched, low impedance source voltages, the manufacturers advice should be sought to determine the most suitable capacitors for such applications.

Non-operating

Both Tantalum and OxiCap™ capacitors contain no liquids or noxious gases to leak out. However, cracking or damage to the encapsulation may lead to premature failure due to ingress of material such as cleaning fluids or to stresses transmitted to the tantalum anode.

4. Fire Characteristics

Primary

Any component subject to abnormal power dissipation may

- self ignite
- become red hot
- break open or explode emitting flaming or red hot material, solid, molten or gaseous.

Fumes from burning components will vary in composition depending on the temperature, and should be considered to be hazardous, although fumes from a single component in a well ventilated area are unlikely to cause problems.

Secondary

Induced ignition may occur from an adjacent burning or red hot component. Epoxy resins used in the manufacture of capacitors give off noxious fumes when burning as stated above. Wherever possible, capacitors comply with the following: BS EN 60065

UL 492.60A/280

LOI (ASTM D2863-70) as stated in the datasheets.

5. Storage

Tantalum and OxiCap™ capacitors exhibit a very low random failure rate after long periods of storage and apart from this there are no known modes of failure under normal storage conditions. All capacitors will withstand any environmental conditions within their ratings for the periods given in the detail specifications. Storage for longer periods under high humidity conditions may affect the leakage current of resin protected capacitors. Solderability of solder coated surfaces may be affected by storage of excess of 2 years. Recommended storage conditions: Temperature: 15°C-35°C

Humidity: 45-75% RH

6. Disposal

Incineration of epoxy coated capacitors will cause emission of noxious fumes and metal cased capacitors may explode due to build up of internal gas pressure. Disposal by any other means normally involves no special hazards. Large quantities may have salvage value.

7. Unsafe Use

Most failures are of a passive nature and do not represent a safety hazard. A hazard may, however, arise if this failure causes a dangerous malfunction of the equipment in which the capacitor is employed. Circuits should be designed to fail safe under the normal modes of failure. The usual failure mode is an increase in leakage current or short circuit. Other possible modes are decrease of capacitance, increase in dissipation factor (and impedance) or an open-circuit. Operations outside the ratings quoted in the datasheets represents unsafe use.

8. Handling

Careless handling of the cut terminal leads could result in scratches and/or skin punctures. Hands should be washed after handling solder coated terminals before eating or smoking, to avoid ingestion of lead. Capacitors must be kept out of the reach of small children. Care must be taken to discharge capacitors before handling as capacitors may retain a residual charge even after equipment in which they are being used has been switched off. Sparks from the discharge could ignite a flammable vapor.

Environmental Information

AVX has always sought to minimize the environmental impact of its manufacturing operations and of its capacitors supplied to customers throughout the world. We have a policy of preventing and minimizing waste streams during manufacture, and recycling materials wherever possible. We actively avoid or minimize environmentally hazardous materials in our production processes.

1. Material Content

For customers wishing to assess the environmental impact of AVX's capacitors contained in waste electrical and electronic equipment, the following information is provided:

Surface mount tantalum capacitors contain:

- Tantalum/Niobium and Tantalum/Niobium oxide
- Manganese dioxide
- Carbon/graphite
- Silver
- Nickel-iron alloy or Copper alloy depending on design (consult factory for details)
- Tin/Tin-lead alloy plating
- Polymers including fluorinated polymers
- Epoxy resin encapsulant

The encapsulant is made fire retardant to UL 94 V-0 by the inclusion of inert mineral filler, antimony trioxide and an organic bromine compound.

2. AVX capacitors do not contain any Polybrominated Biphenyl (PBB) or PBBE/PBBO, Mercury (Hg), Cadmium (Cd) or Hexavalent Chromium (Cr₆₊).

The approximate content of some materials is given in the table below for TAJ, TPS, THJ, TRJ, TPM, TCJ, TLJ, NOJ, NOS, and NOM series:

Case Size	Tantalum			Niobium Oxide	
	Typical Weight (mg)	Antimony Trioxide (%)	Organic Bromine Compound (%)	Case Size	Typical Weight (mg)
A	31	1.2	0.9	A	26
B	72	1.0	0.7	B	56
C	194	0.9	0.7	C	154
D	373	0.8	0.6	D	279
E	531	1.0	0.7	E	399
V	681	1.1	0.8	V	510
P	15	1.1	0.8	P	12
R	10	1.0	0.7	R	9
S	19	1.3	1.0	S	17
T	35	1.1	0.9	T	32
W	97	1.1	0.8	W	82
X	158	1.1	0.8	X	127
Y	237	1.2	0.9	Y	182
H	51	0.0	0.0		
F	148	0.6	0.4		
K	17.3	0.9	0.7		

NOJ, NOS, NOM series does not contain lead, antimony trioxide or organic bromine compound.

TAC series does not contain lead, antimony trioxide or organic bromine compound.

The specific weight of other materials contained in the various case sizes is available on written request. The component packing tape is either recyclable Polycarbonate or PVC (depending on case size), and the sealing tape is a laminate of halogen-free polymers. The reels are recyclable polystyrene, and marked with the recycling symbol. The reels are over-packed in recyclable fiber board boxes. None of the packing contains heavy metals.

3. Lead

Parts supplied today are electroplated over the terminal contact area with 100% Tin (Sn). Older products may contain lead comprising much less than 0.2% of the component weight.

4. Fire Retardants

Currently the only known way of supplying a fire retardant encapsulant which meets all our performance requirements, is to incorporate antimony trioxide and an organic bromine compound. These materials are commonly used in many plastic items in the home and industry. We expect to be able to offer an alternative fire retardant encapsulant, free of these materials, by 2005. A combustible encapsulant free of these materials could be supplied today, but AVX believes that the health and safety benefits of using these materials to provide fire retardancy during the life of the product, far outweigh the possible risks to the environment and human health.

5. Nickel alloy

It is intended that all case sizes will be made with a high copper alloy termination. Some case sizes are supplied now with this termination, and other sizes may be available. Please contact AVX if you prefer this.

6. Recycling

Surface mount Tantalum and OxiCap™ capacitors have a very long service life with no known wear-out mechanism, and a low failure rate. However, parts contained in equipment which is of no further use will have some residual value mainly because of the Tantalum metal or niobium oxide contained. This can be recovered and recycled by specialist companies. The silver and nickel or copper alloy will also have some value. Please contact AVX if you require assistance with the disposal of parts. Packaging can be recycled as described above.

7. Disposal

Surface mount Tantalum and OxiCap™ capacitors do not contain any liquids and no part of the devices is normally soluble in water at neutral pH values. Incineration will cause the emission of noxious fumes and is not recommended except by specialists. Landfill may be considered for disposal, bearing in mind the small lead content.

Under certain extreme physical conditions it is possible to generate ignition of Tantalum, Niobium and Niobium oxide capacitors. These physical conditions relate to high-speed impact and although not considered to be a normal operating occurrence may occur as a method of material(s) recovery. Therefore appropriate safeguards procedures and methodologies need to be adopted to eliminate any risks of material ignition.

Environmental Information

For further information, please contact your local AVX sales office or representative.

8. RoHS Compliance

AVX can declare that we do not add any materials from the list below to series TAJ, TPS, THJ, TRJ, TPM, NOJ, NOS, and NOM during production, so they are not contained in any significant level.

Substances	Taping Code	RoHS Compliance	
Heavy Metals	Cadmium and cadmium compounds	All	YES
	Lead and lead compounds	A,B,Y,P	YES
		R,S	YES, since production date 1/1/04
	K,H	NO	
Mercury and mercury compounds	All	YES	
Hexavalent chromium compounds	All	YES	
Chlorinated organic compounds	Polychlorinated biphenyls (PCB)	All	YES
	Polychlorinated naphthalenes (PCN)	All	YES
	Chlorinated paraffins (CP)	All	YES
	Mirex (Perchlordecone)	All	YES
Brominated organic compounds	Polybrominated biphenyls (PBB)	All	YES
	Polybrominated diphenylethers (PBDE)	All	YES
Organic tin compounds	All	YES	
Asbestos	All	YES	
Azo compounds	All	YES	
Formaldehyde	All	YES	
Polyvinyl chloride (PVC) and PVC blends	All	YES	
Terpentyne	All	YES	

TAJ, TPS, TRJ, THJ, TPM, TAC, TLC,



TCJ, TBJ, NOS,

Tape and reel packaging for automatic component placement. Please enter required Suffix on order. Bulk packaging is not available.

TAPE SPECIFICATION

Tape dimensions comply to EIA 481-1 Dimensions A₀ and B₀ of the pocket and the tape thickness, K, are dependent on the component size. Tape materials do not affect component solderability during storage. Carrier Tape Thickness <0.4mm.

TAPING SUFFIX TABLE TAJ, TPS, TRJ, THJ, TPM, TLJ, TCJ, CWR11, TBJ, TBM, NOJ, NOS, NOM, NBJ and NBM

Case Size	Tape width mm	P mm	100mm (4") reel		180mm (7") reel		330mm (13") reel		180mm (7") reel & Gold Termination	
			Suffix	Qty.	Suffix	Qty.	Suffix	Qty.	Suffix	Qty.
A	8	4			R	2000	S	8000	A	2000
B	8	4			R	2000	S	8000	A	2000
C	12	8			R	500	S	3000	A	500
D	12	8			R	500	S	2500	A	500
E	12	8			R	400	S	1500	A	400
V	12	8			R	400	S	1500	A	400
F	12	8			R	1000	S	4000	A	1000
G	8	4			R	2500	S	10000	A	2500
H	8	4			R	2500	S	10000	A	2500
K	8	4			R	2500	S	10000	A	2500
R	8	4			R	2500	S	10000	A	2500
P	8	4			R	2500	S	10000	A	2500
S	8	4			R	2500	S	10000	A	2500
T	8	4			R	2500	S	10000	A	2500
W	12	8			R	1000	S	5000	A	1000
Y	12	8			R	1000	S	4000	A	1000
X	12	8			R	1000	S	5000	A	1000

TAPING SUFFIX TABLE TAC, TPC and TLC

Case Size	Tape width mm	P mm	100mm (4") reel Tin Termination		180mm (7") reel Tin Termination		100mm (4") reel & Gold Termination		180mm (7") reel & 100% Gold Termination	
			Suffix	Qty.	Suffix	Qty.	Suffix	Qty.	Suffix	Qty.
K	8	2	QTA	1000	PTA	10,000				
L	8	4	XTA	500	RTA	3,500	FTA	500	ATA	3,500
R	8	4	XTA	500	RTA	2,500	FTA	500	ATA	2,500
H	8	4	XTA	500	RTA	3,500	FTA	500	ATA	3,500
U	8	4	XTA	500	RTA	3,500	FTA	500	ATA	3,500
X	8	4	XTA	500	RTA	2,000	FTA	500	ATA	2,000
A	8	4	XTA	500	RTA	2,000	FTA	500	ATA	2,000
T	8	4	XTA	500	RTA	2,500	-	-	-	-

PLASTIC TAPE DIMENSIONS TAJ, TPS, TRJ, THJ, TPM, TLJ, TCJ, CWR11, TBJ, TBM, NOJ, NOS, NOM, NBJ and NBM

Case	A0±0.10	B0±0.10	K±0.10	W±0.30	E±0.10	F±0.05	G min.	P±0.10	P2±0.05	P0±0.10	D0 ^{+0.20} _{-0.00}	D1 ^{+0.20} _{-0.00}
A	1.83	3.57	1.87	8.00	1.75	3.50	0.75	4.00	2.00	4.00	1.50	1.00
B	3.15	3.77	2.22	8.00	1.75	3.50	0.75	4.00	2.00	4.00	1.50	1.00
C	3.45	6.40	2.92	12.0	1.75	5.50	0.75	8.00	2.00	4.00	1.50	1.50
D	4.48	7.62	3.22	12.0	1.75	5.50	0.75	8.00	2.00	4.00	1.50	1.50
E	4.50	7.50	4.50	12.0	1.75	5.50	0.75	8.00	2.00	4.00	1.50	1.50
V	6.43	7.44	3.84	12.0	1.75	5.50	0.75	8.00	2.00	4.00	1.50	1.50
W	3.57	6.40	1.65	12.0	1.75	5.50	0.75	8.00	2.00	4.00	1.50	1.50
X	4.67	7.62	1.65	12.0	1.75	5.50	0.75	8.00	2.00	4.00	1.50	1.50
Y	4.67	7.62	2.15	12.0	1.75	5.50	0.75	8.00	2.00	4.00	1.50	1.50
R	1.65	2.45	1.30	8.00	1.75	3.50	0.75	4.00	2.00	4.00	1.50	1.00
P	1.65	2.45	1.60	8.00	1.75	3.50	0.75	4.00	2.00	4.00	1.50	1.00
S	1.95	3.55	1.30	8.00	1.75	3.50	0.75	4.00	2.00	4.00	1.50	1.00
T	3.20	3.80	1.30	8.00	1.75	3.50	0.75	4.00	2.00	4.00	1.50	1.00

PLASTIC TAPE DIMENSIONS TAC, TPC and TLC

Plastic	Case	A0±0.025	B0±0.05	W±0.30	E±0.10	F±0.05	P±0.10	P2±0.05	P0±0.10	D ^{+0.10} _{-0.00}	D1 ^{+0.10} _{-0.00}	K±0.05
	L	1.025	1.95	8	1.75	3.5	4	2	4	1.5	0.8	1.1
Plastic	Case	A0±0.05	B0±0.10	W±0.30	E±0.10	F±0.05	P±0.10	P2±0.05	P0±0.10	D ^{+0.10} _{-0.00}	D1 Min.	K±0.05
	R	1.7	2.45	8	1.75	3.5	4	2	4	1.5	1.0	1.7
	H	1.7	2.45	8	1.75	3.5	4	2	4	1.5	1.0	1.1
	U	1.7	2.45	8	1.75	3.5	4	2	4	1.5	1.0	0.8
Plastic	Case	A0±0.10	B0±0.10	W±0.30	E±0.10	F±0.05	P±0.10	P2±0.05	P0±0.10	D ^{+0.20} _{-0.00}	D1 Min.	K±0.10
	A/X	1.83	3.57	8	1.75	3.5	4	2	4	1.5	1.0	1.87
	T	3.20	3.80	8	1.75	3.5	4	4	2	4	1.50	1.0



TAJ, TPS, TRJ, THJ, TPM, TAC, TCJ Series – Tape and Reel Packaging



REEL DIMENSIONS

Reel Size	Tape	A	B	C	W	t
180mm (7")	12mm	178±2.00	50 min	13.0±0.50	12.4+1.5/-0	1.50±0.50
180mm (7")	8mm	178±2.00	50 min	13.0±0.50	8.4+1.5/-0	1.50±0.50
330mm (13")	12mm	328±2.00	50 min	13.0±0.50	12.4+1.5/-0	1.50±0.50
330mm (13")	8mm	328±2.00	50 min	13.0±0.50	8.4+1.5/-0	1.50±0.50
108mm (4.25")	8mm	108±2.00		13.0±0.50	8.4+1.5/-0	1.50±0.50

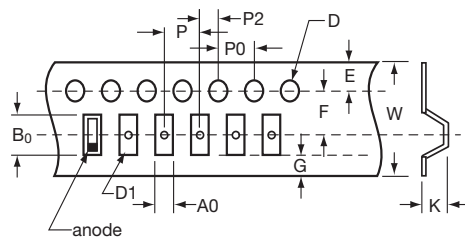
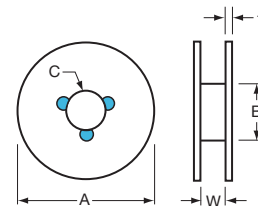

COVER TAPE NOMINAL DIMENSIONS

Thickness: 75µm
 Width of tape: 5.5mm (8mm tape)
 9.5mm (12mm tape)

For TAC Range Only (Paper Tape)

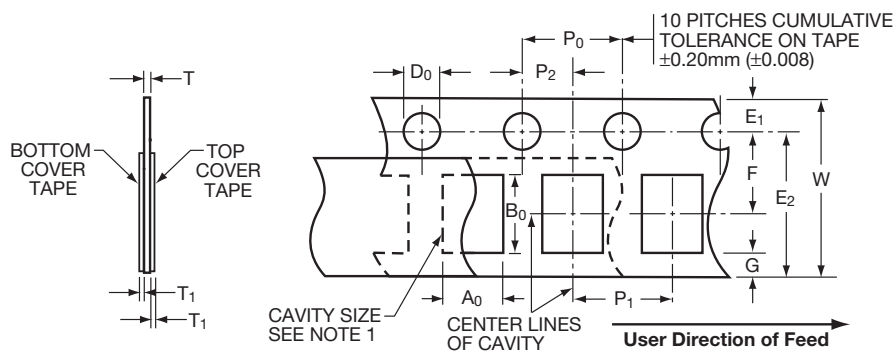

	A ₀	B ₀	W	E	F	P ₁	P ₂	P ₀	D ₀	E ₂	T
	+0.1 -0.05	+0.05 -0.05	±.20	±0.10	±0.05	±0.05	±0.05	±0.1	-0.1 -0.0	Min	±0.05
K	0.75	1.35	8.0	1.75	3.5	2.0	2.0	4.0	1.5	6.25	0.75



TAZ Cots+, CWR09, CWR19 and CWR29 Series



Tape and Reel Packaging

Solid Tantalum Chip TAZ Tape and reel packaging for automatic component placement.
Please enter required Suffix on order. Bulk packaging is standard.

TAZ TAPING SUFFIX TABLE

Case Size reference	Tape width mm	P mm	7" (180mm) reel		13" reel (330mm) reel	
			Suffix	Qty.	Suffix	Qty.
A	8	4	R	2500	S	9000
B	12	4	R	2500	S	9000
C	12	4	R	2500	S	9000
D	12	4	R	2500	S	8000
E	12	4	R	2500	S	8000
F	12	8	R	1000	S	3000
G	12	8	R	500	S	2500
H	12	8	R	500	S	2500

Total Tape Thickness — K max	
Case size reference	TAZ Millimeters (Inches) DIM
A	2.0 (0.079)
B	4.0 (0.157)
D	4.0 (0.157)
E	4.0 (0.157)
F	4.0 (0.157)
G	4.0 (0.157)
H	4.0 (0.157)

Code	8mm Tape		12mm Tape	
P*	4±0.1 or 8±0.1	(0.157±0.004) (0.315±0.004)	4±0.1 or 8±0.1	(0.157±0.004) (0.315±0.004)
G	0.75 min	(0.03 min)	0.75 min	(0.03 min)
F	3.5±0.04	(0.138±0.002)	5.5±0.05	(0.22±0.002)
E	1.75±0.1	(0.069±0.004)	1.75±0.1	(0.069±0.004)
W	8±0.3	(0.315±0.012)	12±0.3	(0.472±0.012)
P ₂	2±0.05	(0.079±0.002)	2±0.05	(0.079±0.002)
P ₀	4±0.1	(0.157±0.004)	4±0.1	(0.157±0.004)
D	1.5±0.1 -0	(0.059±0.004) (-0)	1.5±0.1 -0	(0.059±0.004) (-0)
D ₁	1.0 min	(0.039 min)	1.5 min	(0.059 min)

*See taping suffix tables for actual P dimension (component pitch).

TAPE SPECIFICATION

Tape dimensions comply to EIA RS 481 A
Dimensions A₀ and B₀ of the pocket and the tape thickness, K, are dependent on the component size.

Tape materials do not affect component solderability during storage.

Carrier Tape Thickness <0.4mm

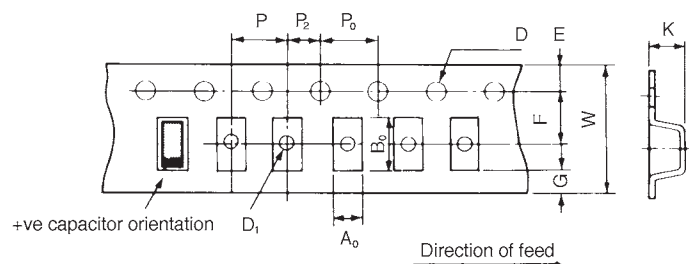

TAJ, TRJ, THJ, TPS, TPM, NOS, TAC and TCJ



Marking

For TAJ, TPS & THJ, the positive end of body has videcon readable polarity marking as shown in the diagram. Bodies are marked by indelible laser marking on top surface with capacitance value, voltage, date of manufacture and batch ID number. R and P case is an exception due to small size in which only the voltage and capacitance values are printed.

Voltage Code	Rated Voltage at 85°C	Voltage Code	Rated Voltage at 85°C
F	2.5	D	20
G	4	E	25
J	6.3	V	35
A	10	T	50
C	16		

TAJ, TRJ, TPS, TPM & TCJ – A, B, C, D, E, F, K, H, S, T, V, W, Y and X CASE:

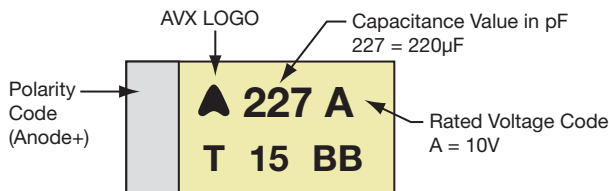

TCJ – A, B, W CASE:

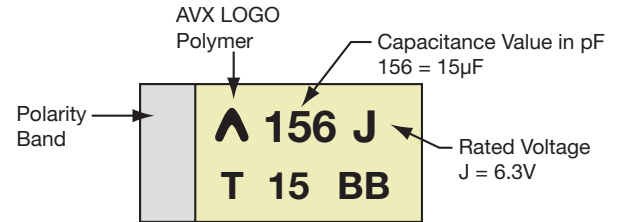

THJ – A, B, C, D CASE:

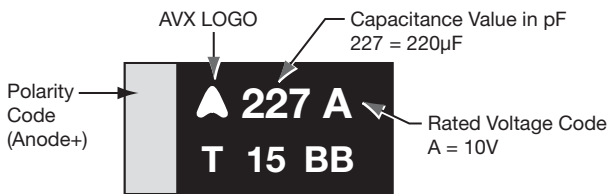

TLJ – A, B, T, W CASE:

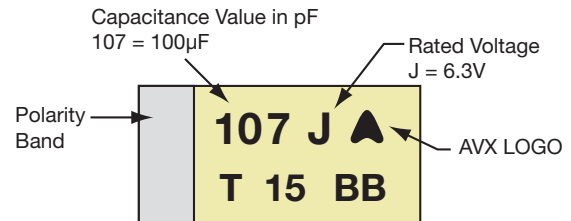

NOJ, NOS, NOM, CoreCap – A, B, C, D, E and V CASE:

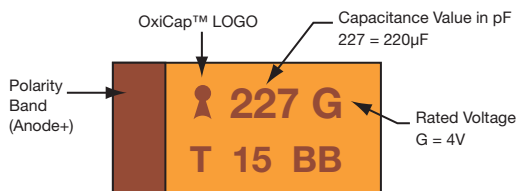

TLJ – P, R CASE:

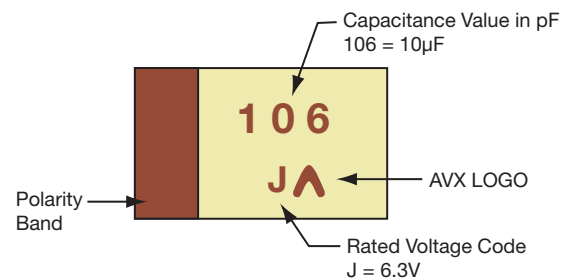

TAJ – R and P CASE:

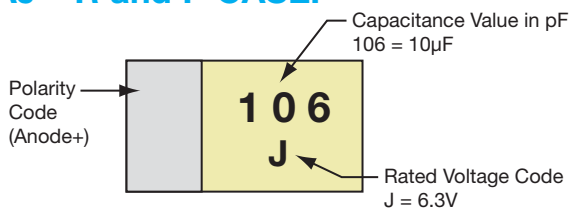

NOJ – P CASE:

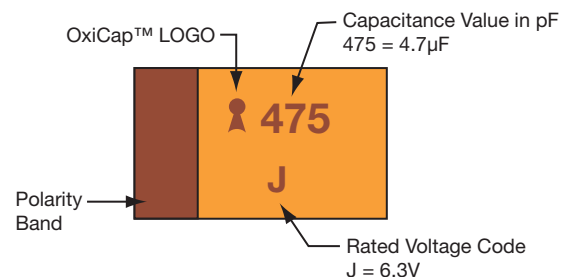

TAP Technical Summary and Application Guidelines



SECTION 1: ELECTRICAL CHARACTERISTICS AND EXPLANATION OF TERMS

1.1 CAPACITANCE

1.1.1 Rated capacitance (C_R)

This is the nominal rated capacitance. For tantalum capacitors it is measured as the capacitance of the equivalent series circuit at 20°C in a measuring bridge supplied by a 120 Hz source free of harmonics with 2.2V DC bias max.

1.1.2 Temperature dependence on the capacitance

The capacitance of a tantalum capacitor varies with temperature. This variation itself is dependent to a small extent on the rated voltage and capacitor size. See graph below for typical capacitance changes with temperature.

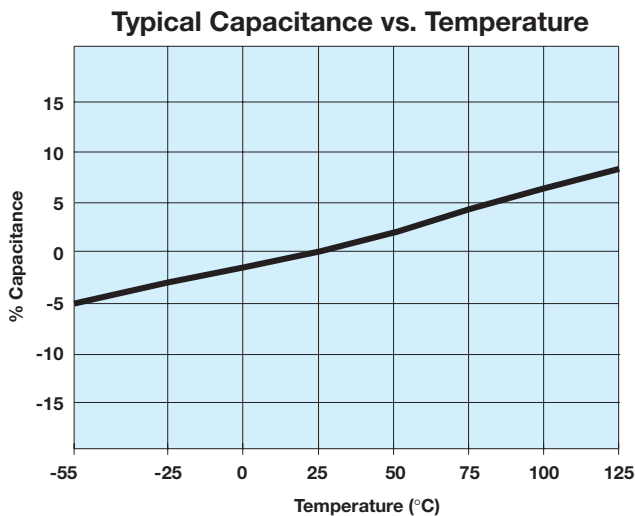

1.1.3 Capacitance tolerance

This is the permissible variation of the actual value of the capacitance from the rated value.

1.1.4 Frequency dependence of the capacitance

The effective capacitance decreases as frequency increases. Beyond 100 kHz the capacitance continues to drop until resonance is reached (typically between 0.5-5 MHz depending on the rating). Beyond this the device becomes inductive.

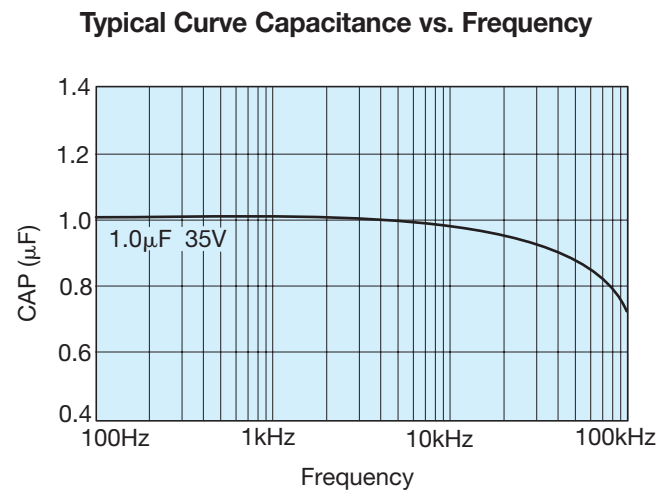

1.2 VOLTAGE

1.2.1 Rated DC voltage (V_R)

This is the rated DC voltage for continuous operation up to +85°C.

1.2.2 Category voltage (V_C)

This is the maximum voltage that may be applied continuously to a capacitor. It is equal to the rated voltage up to +85°C, beyond which it is subject to a linear derating, to 2/3 V_R at 125°C.

1.2.3 Surge voltage (V_S)

This is the highest voltage that may be applied to a capacitor for short periods of time. The surge voltage may be applied up to 10 times in an hour for periods of up to 30 seconds at a time. The surge voltage must not be used as a parameter in the design of circuits in which, in the normal course of operation, the capacitor is periodically charged and discharged.

Category Voltage vs. Temperature

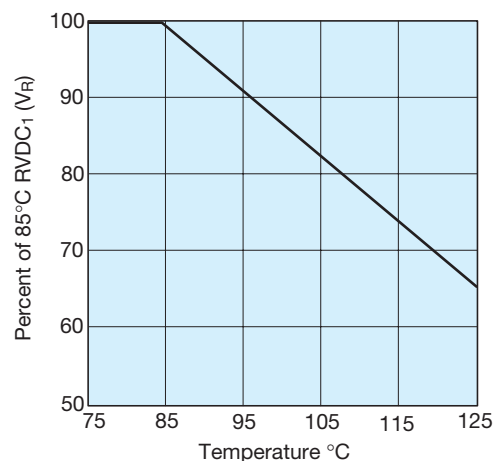

TAP Technical Summary and Application Guidelines



85°C		125°C	
Rated Voltage (V DC)	Surge Voltage (V DC)	Category Voltage (V DC)	Surge Voltage (V DC)
2	2.6	1.3	1.7
3	4	2	2.6
4	5.2	2.6	3.4
6.3	8	4	5
10	13	6.3	9
16	20	10	12
20	26	13	16
25	33	16	21
35	46	23	28
50	65	33	40

1.2.4 Effect of surges

The solid Tantalum capacitor has a limited ability to withstand surges (15% to 30% of rated voltage). This is in common with all other electrolytic capacitors and is due to the fact that they operate under very high electrical stress within the oxide layer. In the case of 'solid' electrolytic capacitors this is further complicated by the limited self healing ability of the manganese dioxide semiconductor.

It is important to ensure that the voltage across the terminals of the capacitor does not exceed the surge voltage rating at any time. This is particularly so in low impedance circuits where the capacitor is likely to be subjected to the full impact of surges, especially in low inductance applications. Even an extremely short duration spike is likely to cause damage. In such situations it will be necessary to use a higher voltage rating.

1.3 DISSIPATION FACTOR AND TANGENT OF LOSS ANGLE (TAN δ)

1.3.1 Dissipation factor (DF)

Dissipation factor is the measurement of the tangent of the loss angle (Tan δ) expressed as a percentage.

The measurement of DF is carried out at +25°C and 120 Hz with 2.2V DC bias max. with an AC voltage free of harmonics. The value of DF is temperature and frequency dependent.

1.3.2 Tangent of loss angle (Tan δ)

This is a measure of the energy loss in the capacitor. It is expressed as Tan δ and is the power loss of the capacitor divided by its reactive power at a sinusoidal voltage of specified frequency. (Terms also used are power factor, loss factor and dielectric loss, Cos (90 - δ) is the true power factor.) The measurement of Tan δ is carried out at +20°C and 120 Hz with 2.2V DC bias max. with an AC voltage free of harmonics.

1.2.5 Reverse voltage and non-polar operation

The reverse voltage ratings are designed to cover exceptional conditions of small level excursions into incorrect polarity. The values quoted are not intended to cover continuous reverse operation.

The peak reverse voltage applied to the capacitor must not exceed:

10% of rated DC working voltage to a maximum of 1V at 25°C

3% of rated DC working voltage to a maximum of 0.5V at 85°C

1% of category DC working voltage to a maximum of 0.1V at 125°C

1.2.6 Non-polar operation

If the higher reverse voltages are essential, then two capacitors, each of twice the required capacitance and of equal tolerance and rated voltage, should be connected in a back-to-back configuration, i.e., both anodes or both cathodes joined together. This is necessary in order to avoid a reduction in life expectancy.

1.2.7 Superimposed AC voltage (V_{rms}) - Ripple Voltage

This is the maximum RMS alternating voltage, superimposed on a DC voltage, that may be applied to a capacitor. The sum of the DC voltage and the surge value of the superimposed AC voltage must not exceed the category voltage, V_c. Full details are given in Section 2.

1.2.8 Voltage derating

Refer to section 3.2 (pages 171-172) for the effect of voltage derating on reliability.

1.3.3 Frequency dependence of dissipation factor

Dissipation Factor increases with frequency as shown in the typical curves below.

Typical Curve-Dissipation Factor vs. Frequency

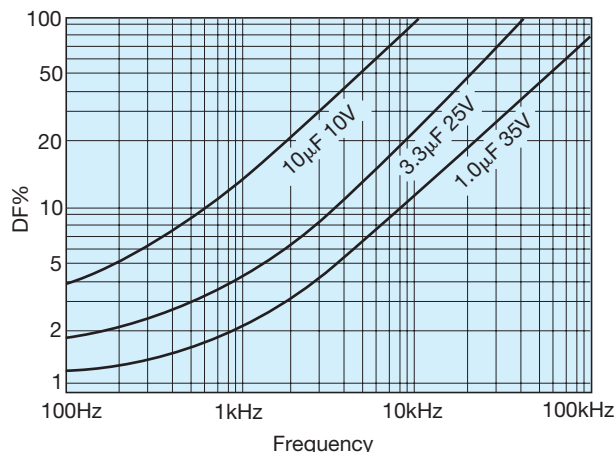

TAP Technical Summary and Application Guidelines



1.3.4 Temperature dependence of dissipation factor

Dissipation factor varies with temperature as the typical curves show to the right. For maximum limits please refer to ratings tables.

Typical Curves-Dissipation Factor vs. Temperature

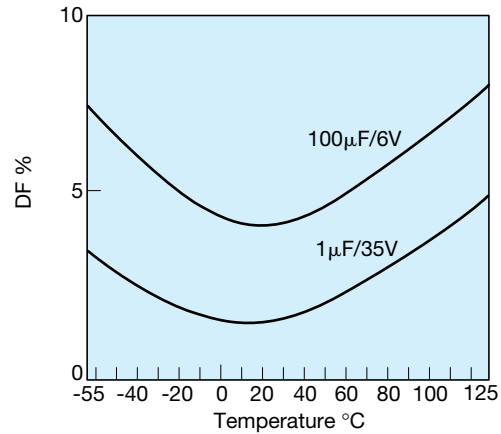

1.4 IMPEDANCE, (Z) AND EQUIVALENT SERIES RESISTANCE (ESR)

1.4.1 Impedance, Z

This is the ratio of voltage to current at a specified frequency. Three factors contribute to the impedance of a tantalum capacitor; the resistance of the semiconducting layer, the capacitance, and the inductance of the electrodes and leads.

At high frequencies the inductance of the leads becomes a limiting factor. The temperature and frequency behavior of these three factors of impedance determine the behavior of the impedance Z. The impedance is measured at 25°C and 100 kHz.

1.4.2 Equivalent series resistance, ESR

Resistance losses occur in all practical forms of capacitors. These are made up from several different mechanisms, including resistance in components and contacts, viscous forces within the dielectric, and defects producing bypass current paths. To express the effect of these losses they are considered as the ESR of the capacitor. The ESR is frequency dependent. The ESR can be found by using the relationship:

$$ESR = \frac{\tan \delta}{2\pi f C}$$

where f is the frequency in Hz, and C is the capacitance in farads. The ESR is measured at 25°C and 100 kHz.

ESR is one of the contributing factors to impedance, and at high frequencies (100 kHz and above) is the dominant factor, so that ESR and impedance become almost identical, impedance being marginally higher.

1.4.3 Frequency dependence of impedance and ESR

ESR and impedance both increase with decreasing frequency. At lower frequencies the values diverge as the extra contributions to impedance (resistance of the semiconducting layer, etc.) become more significant. Beyond 1 MHz (and beyond the resonant point of the capacitor) impedance again increases due to induction.

Frequency Dependence of Impedance and ESR

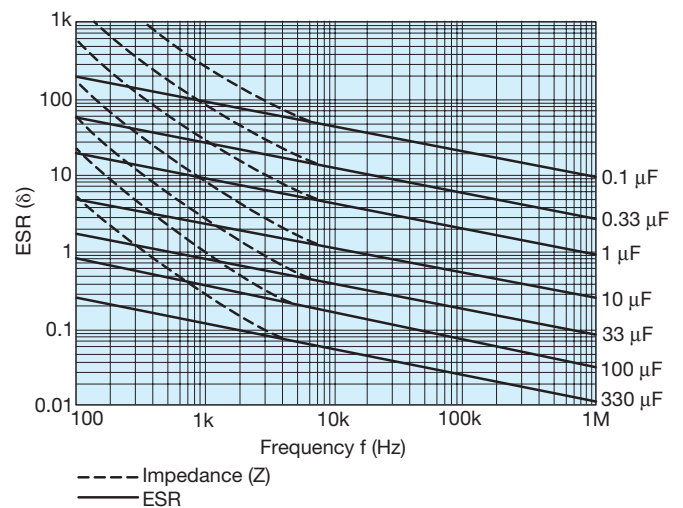

TAP Technical Summary and Application Guidelines



1.4.4 Temperature dependence of the impedance and ESR

At 100 kHz, impedance and ESR behave identically and decrease with increasing temperature as the typical curves show. For maximum limits at high and low temperatures, please refer to graph opposite.

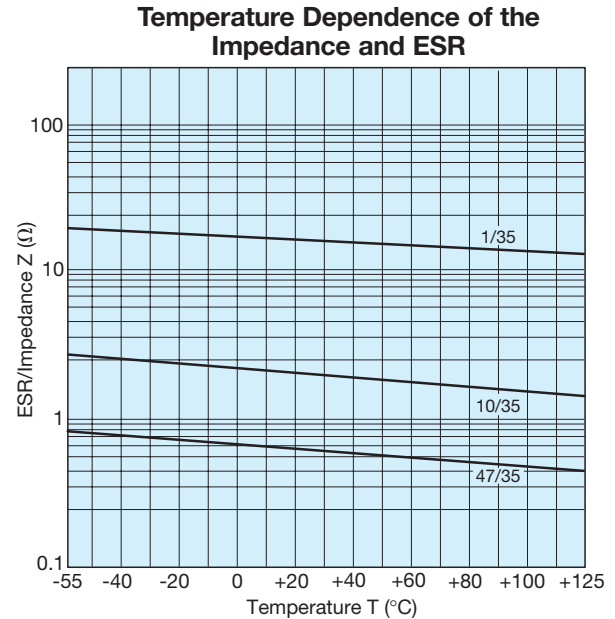

1.5 DC LEAKAGE CURRENT (DCL)

1.5.1 Leakage current (DCL)

The leakage current is dependent on the voltage applied, the time, and the capacitor temperature. It is measured at +25°C with the rated voltage applied. A protective resistance of 1000Ω is connected in series with the capacitor in the measuring circuit.

Three minutes after application of the rated voltage the leakage current must not exceed the maximum values indicated in the ratings table. Reforming is unnecessary even after prolonged periods without the application of voltage.

1.5.2 Temperature dependence of the leakage current

The leakage current increases with higher temperatures, typical values are shown in the graph.

For operation between 85°C and 125°C, the maximum working voltage must be derated and can be found from the following formula.

$$V_{\max} = \left(1 - \frac{T-85}{120}\right) \times V_R \text{ volts}$$

where T is the required operating temperature. Maximum limits are given in rating tables.

1.5.3 Voltage dependence of the leakage current

The leakage current drops rapidly below the value corresponding to the rated voltage V_R when reduced voltages are applied. The effect of voltage derating on the leakage current is shown in the graph.

This will also give a significant increase in reliability for any application. See Section 3 (pages 170-172) for details.

1.5.4 Ripple current

The maximum ripple current allowance can be calculated from the power dissipation limits for a given temperature rise above ambient. Please refer to Section 2 (page 169) for details.

Temperature Dependence of the Leakage Current for a Typical Component

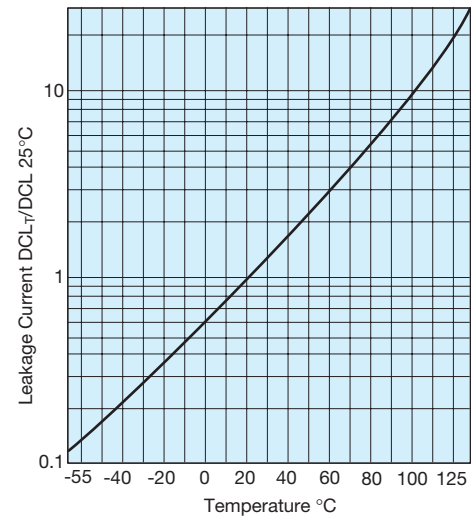

Effect of Voltage Derating on Leakage Current

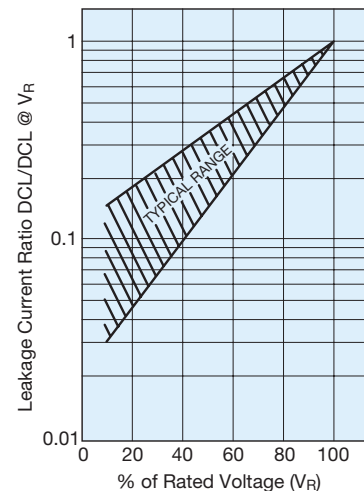

TAP Technical Summary and Application Guidelines



SECTION 2: AC OPERATION — RIPPLE VOLTAGE AND RIPPLE CURRENT

2.1 RIPPLE RATINGS (AC)

In an AC application heat is generated within the capacitor by both the AC component of the signal (which will depend upon signal form, amplitude and frequency), and by the DC leakage. For practical purposes the second factor is insignificant. The actual power dissipated in the capacitor is calculated using the formula:

$$P = I^2 R = \frac{E^2 R}{Z^2}$$

- I = rms ripple current, amperes
- R = equivalent series resistance, ohms
- E = rms ripple voltage, volts
- P = power dissipated, watts
- Z = impedance, ohms, at frequency under consideration

Using this formula it is possible to calculate the maximum AC ripple current and voltage permissible for a particular application.

2.2 MAXIMUM AC RIPPLE VOLTAGE (E_{\max})

From the previous equation:

$$E_{(\max)} = Z \sqrt{\frac{P_{\max}}{R}}$$

where P_{\max} is the maximum permissible ripple voltage as listed for the product under consideration (see table).

However, care must be taken to ensure that:

1. The DC working voltage of the capacitor must not be exceeded by the sum of the positive peak of the applied AC voltage and the DC bias voltage.
2. The sum of the applied DC bias voltage and the negative peak of the AC voltage must not allow a voltage reversal in excess of that defined in the sector, 'Reverse Voltage'.

2.3 MAXIMUM PERMISSIBLE POWER DISSIPATION (WATTS) @ 25°C

The maximum power dissipation at 25°C has been calculated for the various series and are shown in Section 2.4, together with temperature derating factors up to 125°C.

For leaded components the values are calculated for parts supported in air by their leads (free space dissipation).

The ripple ratings are set by defining the maximum temperature rise to be allowed under worst case conditions, i.e., with resistive losses at their maximum limit. This differential is normally 10°C at room temperature dropping to 2°C at 125°C. In application circuit layout, thermal management, available ventilation, and signal waveform may significantly

affect the values quoted below. It is recommended that temperature measurements are made on devices during operating conditions to ensure that the temperature differential between the device and the ambient temperature is less than 10°C up to 85°C and less than 2°C between 85°C and 125°C. Derating factors for temperatures above 25°C are also shown below. The maximum permissible proven dissipation should be multiplied by the appropriate derating factor.

For certain applications, e.g., power supply filtering, it may be desirable to obtain a screened level of ESR to enable higher ripple currents to be handled. Please contact our applications desk for information.

2.4 POWER DISSIPATION RATINGS (IN FREE AIR)

TAR – Molded Axial

Case size	Max. power dissipation (W)	Temperature derating factors	
		Temp. °C	Factor
Q	0.065	+25	1.0
R	0.075	+85	0.6
S	0.09	+125	0.4
W	0.105		

TAA – Hermetically Sealed Axial

Case size	Max. power dissipation (W)	Temperature derating factors	
		Temp. °C	Factor
A	0.09	+20	1.0
B	0.10	+85	0.9
C	0.125	+125	0.4
D	0.18		

TAP – Resin Dipped Radial

Case size	Max. power dissipation (W)	Temperature derating factors	
		Temp. °C	Factor
A	0.045	+25	1.0
B	0.05	+85	0.4
C	0.055	+125	0.09
D	0.06		
E	0.065		
F	0.075		
G	0.08		
H	0.085		
J	0.09		
K	0.1		
L	0.11		
M/N	0.12		
P	0.13		
R	0.14		



TAP Technical Summary and Application Guidelines



SECTION 3: RELIABILITY AND CALCULATION OF FAILURE RATE

3.1 STEADY-STATE

Tantalum Dielectric has essentially no wear out mechanism and in certain circumstances is capable of limited self healing, random failures can occur in operation. The failure rate of Tantalum capacitors will decrease with time and not increase as with other electrolytic capacitors and other electronic components.

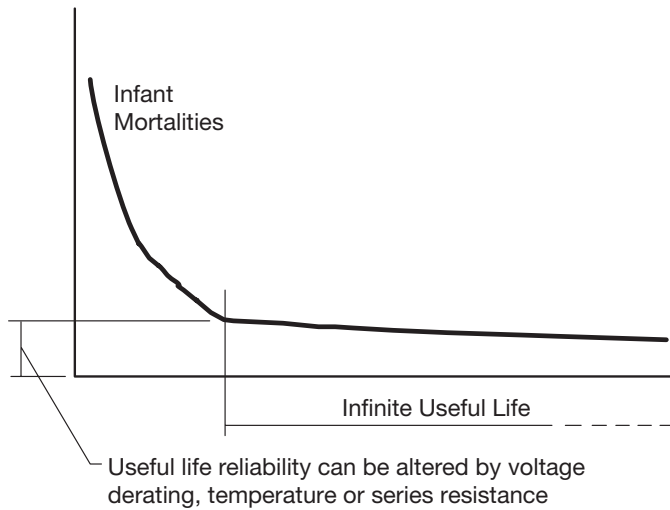

Figure 1. Tantalum reliability curve.

The useful life reliability of the Tantalum capacitor is affected by three factors. The equation from which the failure rate can be calculated is:

$$F = F_U \times F_T \times F_R \times F_B$$

where F_U is a correction factor due to operating voltage/voltage derating

F_T is a correction factor due to operating temperature

F_R is a correction factor due to circuit series resistance

F_B is the basic failure rate level. For standard leaded Tantalum product this is 1%/1000hours

Operating voltage/voltage derating

If a capacitor with a higher voltage rating than the maximum line voltage is used, then the operating reliability will be improved. This is known as voltage derating. The graph, Figure 2, shows the relationship between voltage derating (the ratio between applied and rated voltage) and the failure rate. The graph gives the correction factor F_U for any operating voltage.

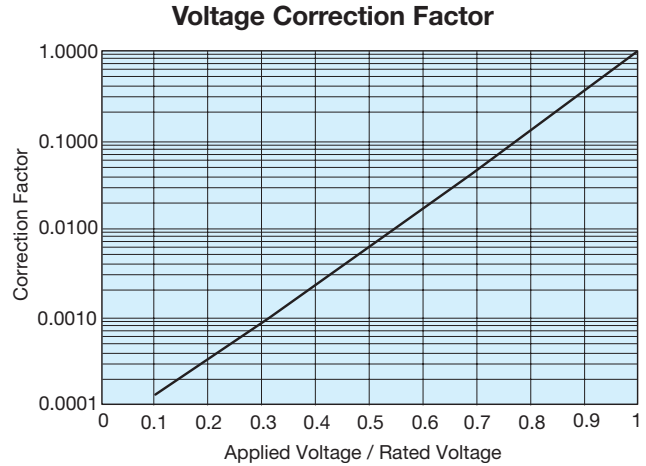

Figure 2. Correction factor to failure rate F for voltage derating of a typical component (60% con. level).

Operating temperature

If the operating temperature is below the rated temperature for the capacitor then the operating reliability will be improved as shown in Figure 3. This graph gives a correction factor F_T for any temperature of operation.

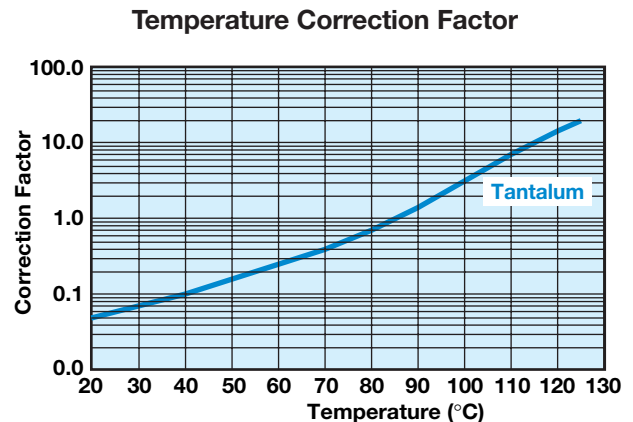

Figure 3. Correction factor to failure rate F for ambient temperature T for typical component (60% con. level).



TAP Technical Summary and Application Guidelines



Circuit Impedance

All solid tantalum capacitors require current limiting resistance to protect the dielectric from surges. A series resistor is recommended for this purpose. A lower circuit impedance may cause an increase in failure rate, especially at temperatures higher than 20°C. An inductive low impedance circuit may apply voltage surges to the capacitor and similarly a non-inductive circuit may apply current surges to the capacitor, causing localized over-heating and failure. The recommended impedance is 1Ω per volt. Where this is not feasible, equivalent voltage derating should be used (See MIL HANDBOOK 217E). Table I shows the correction factor, F_R , for increasing series resistance.

Table I: Circuit Impedance

Correction factor to failure rate F for series resistance R on basic failure rate F_B for a typical component (60% con. level).

Circuit Resistance ohms/volt	FR
3.0	0.07
2.0	0.1
1.0	0.2
0.8	0.3
0.6	0.4
0.4	0.6
0.2	0.8
0.1	1.0

Example calculation

Consider a 12 volt power line. The designer needs about 10μF of capacitance to act as a decoupling capacitor near a video bandwidth amplifier. Thus the circuit impedance will be limited only by the output impedance of the boards power unit and the track resistance. Let us assume it to be about 2 Ohms minimum, i.e., 0.167 Ohms/Volt. The operating temperature range is -25°C to +85°C. If a 10μF 16 Volt capacitor was designed-in, the operating failure rate would be as follows:

- a) $F_T = 0.8 @ 85^\circ\text{C}$
- b) $F_R = 0.7 @ 0.167 \text{ Ohms/Volt}$
- c) $F_U = 0.17 @ \text{applied voltage/rated voltage} = 75\%$

Thus $F_B = 0.8 \times 0.7 \times 0.17 \times 1 = 0.0952\%/1000 \text{ Hours}$

If the capacitor was changed for a 20 volt capacitor, the operating failure rate will change as shown.

$F_U = 0.05 @ \text{applied voltage/rated voltage} = 60\%$

$F_B = 0.8 \times 0.7 \times 0.05 \times 1 = 0.028\%/1000 \text{ Hours}$

3.2 DYNAMIC

As stated in Section 1.2.4 (page 166), the solid Tantalum capacitor has a limited ability to withstand voltage and current surges. Such current surges can cause a capacitor to fail. The expected failure rate cannot be calculated by a simple formula as in the case of steady-state reliability. The two parameters under the control of the circuit design engineer known to reduce the incidence of failures are derating and series resistance. The table below summarizes the results of trials carried out at AVX with a piece of equipment which has very low series resistance and applied no derating. So that the capacitor was tested at its rated voltage.

Results of production scale derating experiment

Capacitance and Voltage	Number of units tested	50% derating applied	No derating applied
47μF 16V	1,547,587	0.03%	1.1%
100μF 10V	632,876	0.01%	0.5%
22μF 25V	2,256,258	0.05%	0.3%

As can clearly be seen from the results of this experiment, the more derating applied by the user, the less likely the probability of a surge failure occurring.

It must be remembered that these results were derived from a highly accelerated surge test machine, and failure rates in the low ppm are more likely with the end customer.



TAP Technical Summary and Application Guidelines



A commonly held misconception is that the leakage current of a Tantalum capacitor can predict the number of failures which will be seen on a surge screen. This can be disproved by the results of an experiment carried out at AVX on 47µF 10V surface mount capacitors with different leakage currents. The results are summarized in the table below.

Leakage Current vs Number of Surge Failures

	Number tested	Number failed surge
Standard leakage range 0.1 µA to 1µA	10,000	25
Over Catalog limit 5µA to 50µA	10,000	26
Classified Short Circuit 50µA to 500µA	10,000	25

Again, it must be remembered that these results were derived from a highly accelerated surge test machine, and failure rates in the low ppm are more likely with the end customer.

AVX recommended derating table

Voltage Rail	Working Cap Voltage
3.3	6.3
5	10
10	20
12	25
15	35
≥24	Series Combinations (11)

For further details on surge in Tantalum capacitors refer to J.A. Gill's paper "Surge in Solid Tantalum Capacitors", available from AVX offices worldwide.

An added bonus of increasing the derating applied in a circuit, to improve the ability of the capacitor to withstand surge conditions, is that the steady-state reliability is improved by up to an order. Consider the example of a 6.3 volt capacitor being used on a 5 volt rail. The steady-state reliability of a Tantalum capacitor is affected by three parameters; temperature, series resistance and voltage derating. Assuming 40°C operation and 0.1Ω/volt of series resistance, the scaling factors for temperature and series resistance will both be 0.05 [see Section 3.1 (page 170)]. The derating factor will be 0.15. The capacitors reliability will therefore be

$$\begin{aligned} \text{Failure rate} &= F_U \times F_T \times F_R \times 1\%/1000 \text{ hours} \\ &= 0.15 \times 0.05 \times 1 \times 1\%/1000 \text{ hours} \\ &= 7.5\% \times 10^{-3}/\text{hours} \end{aligned}$$

If a 10 volt capacitor was used instead, the new scaling factor would be 0.017, thus the steady-state reliability would be

$$\begin{aligned} \text{Failure rate} &= F_U \times F_T \times F_R \times 1\%/1000 \text{ hours} \\ &= 0.017 \times 0.05 \times 1 \times 1\%/1000 \text{ hours} \\ &= 8.5\% \times 10^{-4}/1000 \text{ hours} \end{aligned}$$

So there is an order improvement in the capacitors steady-state reliability.

3.3 RELIABILITY TESTING

AVX performs extensive life testing on tantalum capacitors.

- 2,000 hour tests as part of our regular Quality Assurance Program.

Test conditions:

- 85°C/rated voltage/circuit impedance of 3Ω max.
- 125°C/0.67 x rated voltage/circuit impedance of 3Ω max.

3.4 Mode of Failure

This is normally an increase in leakage current which ultimately becomes a short circuit.



TAP Technical Summary and Application Guidelines



SECTION 4: APPLICATION GUIDELINES FOR TANTALUM CAPACITORS

4.1 SOLDERING CONDITIONS AND BOARD ATTACHMENT

The soldering temperature and time should be the minimum for a good connection.

A suitable combination for wavesoldering is 230°C - 250°C for 3 - 5 seconds.

Small parametric shifts may be noted immediately after wave solder, components should be allowed to stabilize at room temperature prior to electrical testing.

AVX leaded tantalum capacitors are designed for wave soldering operations.

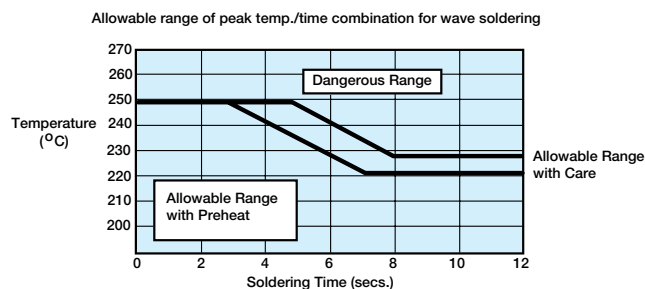

4.2 RECOMMENDED SOLDERING PROFILES

Recommended wave soldering profile for mounting of tantalum capacitors is shown below.

After soldering the assembly should preferably be allowed to cool naturally. In the event that assisted cooling is used, the rate of change in temperature should not exceed that used in reflow.

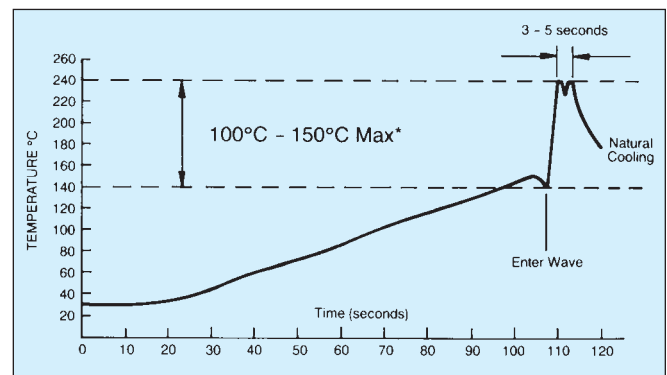

*See appropriate product specification

SECTION 5: MECHANICAL AND THERMAL PROPERTIES, LEADED CAPACITORS

5.1 ACCELERATION

10 g (981 m/s)

5.2 VIBRATION SEVERITY

10 to 2000 Hz, 0.75 mm or 98 m/s²

5.3 SHOCK

Trapezoidal Pulse 10 g (981 m/s) for 6 ms

5.4 TENSILE STRENGTH OF CONNECTION

10 N for type TAR, 5 N for type TAP.

5.5 BENDING STRENGTH OF CONNECTIONS

2 bends at 90°C with 50% of the tensile strength test loading.

5.6 SOLDERING CONDITIONS

Dip soldering permissible provided solder bath temperature $\leq 270^{\circ}\text{C}$; solder time < 3 sec.; circuit board thickness ≥ 1.0 mm.

5.7 INSTALLATION INSTRUCTIONS

The upper temperature limit (maximum capacitor surface temperature) must not be exceeded even under the most unfavorable conditions when the capacitor is installed. This must be considered particularly when it is positioned near components which radiate heat strongly (e.g., valves and power transistors). Furthermore, care must be taken, when bending the wires, that the bending forces do not strain the capacitor housing.

5.8 INSTALLATION POSITION

No restriction.

5.9 SOLDERING INSTRUCTIONS

Fluxes containing acids must not be used.



Technical Summary and Application Guidelines

QUESTIONS AND ANSWERS

Some commonly asked questions regarding Tantalum Capacitors:

Question: If I use several tantalum capacitors in serial/parallel combinations, how can I ensure equal current and voltage sharing?

Answer: Connecting two or more capacitors in series and parallel combinations allows almost any value and rating to be constructed for use in an application. For example, a capacitance of more than 60µF is required in a circuit for stable operation. The working voltage rail is 24 Volts dc with a superimposed ripple of 1.5 Volts at 120 Hz.

The maximum voltage seen by the capacitor is $V_{dc} + V_{ac} = 25.5V$

Applying the 50% derate rule tells us that a 50V capacitor is required.

Connecting two 25V rated capacitors in series will give the required capacitance voltage rating, but the effective capacitance will be halved, so for greater than

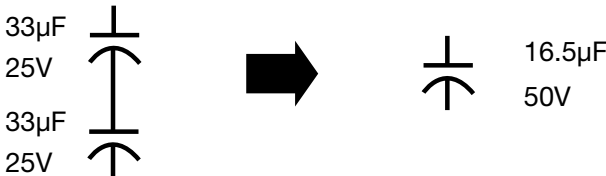

60µF, four such series combinations are required, as shown.

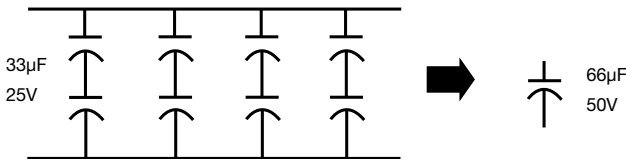

In order to ensure reliable operation, the capacitors should be connected as shown below to allow current sharing of the ac noise and ripple signals. This prevents any one capacitor heating more than its neighbors and thus being the weak link in the chain.

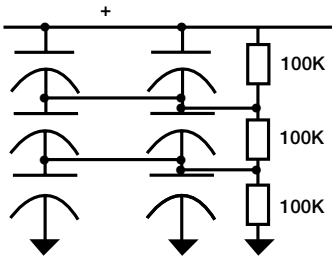

The two resistors are used to ensure that the leakage currents of the capacitors does not affect the circuit reliability, by ensuring that all the capacitors have half the working voltage across them.

Question: What are the advantages of tantalum over other capacitor technologies?

Answer:

1. Tantalums have high volumetric efficiency.
2. Electrical performance over temperature is very stable.
3. They have a wide operating temperature range -55 degrees C to +125 degrees C.
4. They have better frequency characteristics than aluminum electrolytics.
5. No wear out mechanism. Because of their construction, solid tantalum capacitors do not degrade in performance or reliability over time.

Question: If the part is rated as a 25 volt part and you have current surged it, why can't I use it at 25 volts in a low impedance circuit?

Answer: The high volumetric efficiency obtained using tantalum technology is accomplished by using an extremely thin film of tantalum pentoxide as the dielectric. Even an application of the relatively low voltage of 25 volts will produce a large field strength as seen by the dielectric. As a result of this, derating has a significant impact on reliability as described under the reliability section. The following example uses a 22 microfarad capacitor rated at 25 volts to illustrate the point. The equation for determining the amount of surface area for a capacitor is as follows:

$$C = (\epsilon_r \epsilon_0 (A)) / d$$

$$A = (C (d)) / (\epsilon_r \epsilon_0)$$

$$A = ((22 \times 10^{-6}) (170 \times 10^{-9})) / ((8.85 \times 10^{-12}) (27))$$

$$A = 0.015 \text{ square meters (150 square centimeters)}$$

Where C = Capacitance in farads

- A = Dielectric (Electrode) Surface Area (m²)
- d = Dielectric thickness (Space between dielectric) (m)
- ϵ_r = Dielectric constant (27 for tantalum)
- ϵ_0 = Dielectric Constant relative to a vacuum (8.855 x 10⁻¹² Farads x m⁻¹)

To compute the field voltage potential felt by the dielectric we use the following logic.

$$\text{Dielectric formation potential} = \text{Formation Ratio} \times \text{Working Voltage}$$

$$= 4 \times 25$$

$$\text{Formation Potential} = 100 \text{ volts}$$

$$\text{Dielectric (Ta}_2\text{O}_5\text{) Thickness (d) is } 1.7 \times 10^{-9} \text{ Meters Per Volt}$$

$$d = 0.17 \mu \text{ meters}$$

$$\text{Electric Field Strength} = \text{Working Voltage} / d$$

$$= (25 / 0.17 \mu \text{ meters})$$

$$= 147 \text{ Kilovolts per millimeter}$$

$$= 147 \text{ Megavolts per meter}$$

Technical Summary and Application Guidelines



QUESTIONS AND ANSWERS

No matter how pure the raw tantalum powder or the precision of processing, there will always be impurity sites in the dielectric. We attempt to stress these sites in the factory with overvoltage surges, and elevated temperature burn in so that components will fail in the factory and not in your product. Unfortunately, within this large area of tantalum pentoxide, impurity sites will exist in all capacitors. To minimize the possibility of providing enough activation energy for these impurity sites to turn from an amorphous state to a crystalline state that will conduct energy, series resistance and derating is recommended. By reducing the electric field within the anode at these sites, the tantalum capacitor has increased reliability. Tantalums differ from other electrolytics in that charge transients are carried by electronic conduction rather than absorption of ions.

Question: What negative transients can Solid Tantalum Capacitors operate under?

Answer: The reverse voltage ratings are designed to cover exceptional conditions of small level excursions into incorrect polarity. The values quoted are not intended to cover continuous reverse operation. The peak reverse voltage applied to the capacitor must not exceed:

10% of rated DC working voltage to a maximum of 1 volt at 25°C.

3% of rated DC working voltage to a maximum of 0.5 volt at 85°C.

1% of category DC working voltage to a maximum of 0.1 volt at 125°C.

Question: I have read that manufacturers recommend a series resistance of 0.1 ohm per working volt. You suggest we use 1 ohm per volt in a low impedance circuit. Why?

Answer: We are talking about two very different sets of circuit conditions for those recommendations. The 0.1 ohm per volt recommendation is for steady-state conditions. This level of resistance is used as a basis for the series resistance variable in a 1% / 1000 hours 60% confidence level reference. This is what steady-state life tests are based on. The 1 ohm per volt is recommended for dynamic conditions which include current in-rush applications such as inputs to power supply circuits. In many power supply topologies where the di/dt through the capacitor(s) is limited, (such as most implementations of buck (current mode), forward converter, and flyback), the requirement for series resistance is decreased.

Question: How long is the shelf life for a tantalum capacitor?

Answer: Solid tantalum capacitors have no limitation on shelf life. The dielectric is stable and no reformation is required. The only factors that affect future performance of the capacitors would be high humidity conditions and extreme storage temperatures. Solderability of solder coated surfaces may be affected by storage in excess of 2 years. Recommended storage conditions are: Temperature between 15°C and 35°C with humidity 45%-75% RH. Terminations should be checked for solderability in the event an oxidation develops on the solder plating.

Question: What level of voltage derating is needed for Tantalum Capacitors?

Answer: For many years whenever people have asked a tantalum capacitor manufacturer about what were the safe guidelines for using their product, they spoke with one voice “a minimum of 50% voltage derating should be applied”. This message has since become ingrained and automatic. This article challenges this statement and explains why it is not necessarily the case.

The 50% rule came about when tantalum capacitors started to be used on low impedance sources. In such applications, the available current is high and therefore a risk of failure is inherent. Well established by empirical methods and covered in MIL-STD 317, was the fact that the amount of voltage derating has a major influence on the failure rate of a tantalum capacitor (Figure 1). Indeed, from rated voltage to 50% of rated voltage is an improvement in failure rate of more than 100.

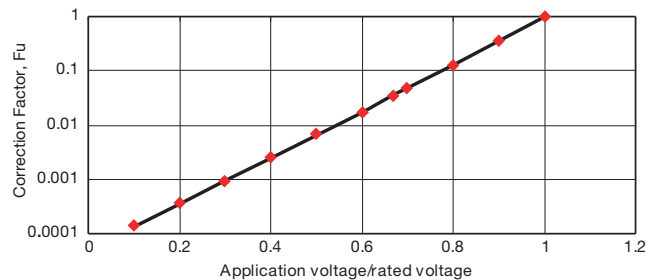
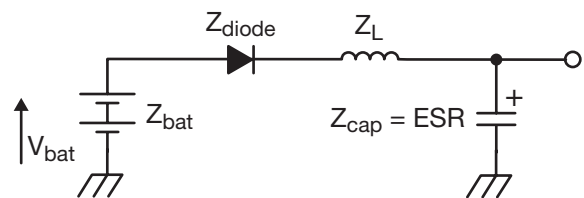

Figure 1

It was also proved that the same was true of dynamic, high current pulse conditions¹, hence the recommendation.

Now let us look more closely at the type of circuits in use. Below is a simple circuit which will be discussed further in this text.



Let us assume this is a 2 cell battery system, therefore $V_{bat} = 3.2$ Volts

Also, let us assume

$Z_{bat} = 60$ m Ω , $Z_{diode} = 70$ m Ω , $Z_{cap} = 120$ m Ω , $Z_L = 70$ m Ω

If the “50% rule” was followed, the designer should choose a 6.3V rated capacitor.

¹ Surge in solid tantalum capacitors, John Gill, AVX Tantalum



Technical Summary and Application Guidelines



The total circuit impedance of the system is 320 mΩ. So by Ohm's law the peak current would be 10 Amps.

This exceeds the test conditions used by AVX to screen its product for high current pulses¹, so a risk of failure exists. Clearly a minimum of a 10 volt rate capacitor is required in this application.

As a general rule of thumb, the maximum current a tantalum capacitor can withstand (provided it has not been damaged by thermomechanical damage^{2 3} or some other external influence) is given by the equation:

$$I_{max} = V_{rated} / (1 + \text{Catalog ESR})$$

So for example for a 100μF 10V D case capacitor (Catalog ESR = 0.9 Ohms), this would be:

$$I_{max} = 10 / (1 + 0.9) = 5.2 \text{ Amps}$$

In some circuits, because of size restrictions, a tantalum capacitor may be the only option available. If this is the case, AVX recommends a PFET integrator be used to slow the voltage ramp at turn on, which in effect reduces the peak current, and therefore reduces the risk of failure⁴.

Now, let's consider a continuation of the circuit with the addition of an LDO or DC/DC convertor.

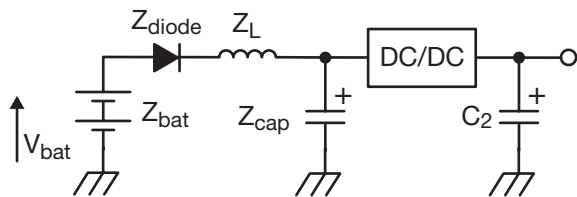

The risk of a high surge current being seen by the capacitor in location C₂ is very small. Therefore if we assume the voltage rail is 2.8 volts and the maximum current seen by C₂ is <1.5 Amps, a 4 volt capacitor could be able to be used in this application.

This all seems like good news, but as always, there are some downsides to using a part nearer to its rated voltage. The first is the steady-state life, or MTBF. The MTBF of a tantalum capacitor is easily calculated from MIL-STD 317 or the supplier's catalog data. An example is given below:

Assume operating temperature is 85°C and circuit impedance 0.1 Ohms/volt (F_T = 1).

For a 10 volt rated capacitor on a 5 volt rated line, the failure rate is:

$$\begin{aligned} F_R &= 1\%/1000 \text{ hours} \times F_T \times F_U \times F_R \\ &= 1\%/1000 \text{ hours} \times 1 \times 0.007 \text{ (from Figure 1)} \times 1 \\ &= 0.007\%/1000 \text{ hours} \end{aligned}$$

$$\begin{aligned} \text{MTBF} &= 10^5 / F_R \\ &= 14,285,238 \text{ hours} \\ &= 1,631 \text{ years} \end{aligned}$$

For a 6.3 volt rated capacitor on a 5 volt rated line, the failure rate is:

$$\begin{aligned} F_R &= 1\%/1000 \text{ hours} \times F_T \times F_U \times F_R \\ &= 1\%/1000 \text{ hours} \times 1 \times 0.12 \text{ (from Figure 1)} \times 1 \\ &= 0.12\%/1000 \text{ hours} \end{aligned}$$

$$\begin{aligned} \text{MTBF} &= 10^5 / F_R \\ &= 833,333 \text{ hours} \\ &= 95 \text{ years} \end{aligned}$$

The second factor to be considered is that the more derating applied to a tantalum capacitor, the lower the leakage current level (Figure 2). Therefore a part used at 50% of its rated voltage will have more than 3 times better leakage levels than one used at 80%.

Leakage Current vs. Rated Voltage

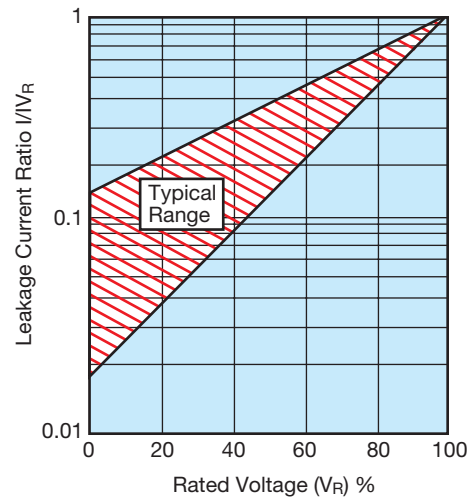

Figure 2

One final point worthy of mention with the introduction of higher reflow temperatures with the introduction of lead-free solders is that voltage derating can help to reduce the risk of failures due to thermomechanical damage during reflow.

To summarize, a tantalum capacitor is capable of being used at its rated voltage or close to it, provided that the user obeys the rules outlined in this document and is prepared for the reduced steady-state life performance and higher leakage current levels this would produce.

¹ Surge in Solid Tantalum Capacitors, John Gill, AVX Tantalum

² IR Reflow Guidelines for Tantalum Capacitors, Steve Warden & John Gill, AVX Tantalum

³ Mounting Guidelines in AVX Tantalum Catalog

⁴ Improving Reliability of Tantalum Capacitors in Low Impedance Circuits, Dave Mattingly, AVX



PASSIVES

Capacitors

Multilayer Ceramic
Film
Glass
Niobium Oxide* - OxiCap™
Pulse Supercapacitors
Tantalum

Circuit Protection

Thermistors
Fuses - Thin Film
Transient Voltage Suppressors
Varistors - Zinc Oxide

Directional Couplers

Thin-Film

Filters

Ceramic
EMI
Noise
SAW
Low Pass - Thin Film

Inductors

Thin-Film

Integrated Passive Components

PMC - Thin-Film Networks
Capacitor Arrays
Feedthru Arrays
Low Inductance Decoupling Arrays

Piezo Acoustic Generators

Ceramic

Resistors

Arrays
Miniature Axials

Timing Devices

Clock Oscillators
MHz Quartz Crystal
Resonators
VCO
TCXO

CONNECTORS

Automotive
Standard, Custom

Board to Board
SMD (0.4, 0.5, 1.0mm), BGA, Thru-Hole

Card Edge

DIN41612
Standard, Inverse, High Temperature

FFC/FPC
0.3, 0.5, 1.0mm

Hand Held, Cellular
Battery, I/O, SIMcard, RF shield clips

2mm Hard Metric
Standard, Reduced Cross-Talk

IDC Wire to Board
Headers, Plugs, Assemblies

Memory
PCMCIA, Compact Flash, Secure Digital, MMC,
Smartcard, SODIMM

Military
H Government, DIN41612

Polytect™
Soft Molding

Rack and Panel
Varicon™

**For more information please visit
our website at
<http://www.avx.com>**

NOTICE: Specifications are subject to change without notice. Contact your nearest AVX Sales Office for the latest specifications. All statements, information and data given herein are believed to be accurate and reliable, but are presented without guarantee, warranty, or responsibility of any kind, expressed or implied. Statements or suggestions concerning possible use of our products are made without representation or warranty that any such use is free of patent infringement and are not recommendations to infringe any patent. The user should not assume that all safety measures are indicated or that other measures may not be required. Specifications are typical and may not apply to all applications.

© AVX Corporation

"Niobium Oxide Capacitors are manufactured and sold under patent license from Cabot Corporation, Boyertown, Pennsylvania U.S.A."